

UTC TL074 LINEAR INTEGRATED CIRCUIT

LOW NOISE QUAD J-FET OPERATIONAL AMPLIFIER

DESCRIPTION

The UTC TL074 is a high speed J-FET input quad operational amplifier. It incorporates well matched, high voltage J-FET and bipolar transistors in a monolithic integrated circuit. The device features high slew rates, low input bias and offset current, and low offset voltage temperature coefficient.

FEATURES

- *Low power consumption
- *Wide common-mode (up to V_{CC}^+) and differential voltage range
- *Low input bias and offset current
- *Low noise $e_n = 15nV / \sqrt{Hz}$ (typ)
- *Output short-circuit protection
- *High input impedance J-FET input stage
- *Low harmonic distortion:0.01%(typ)
- *Internal frequency compensation
- *Latch up free operation
- *High slewrate:13V/ μs (typ)

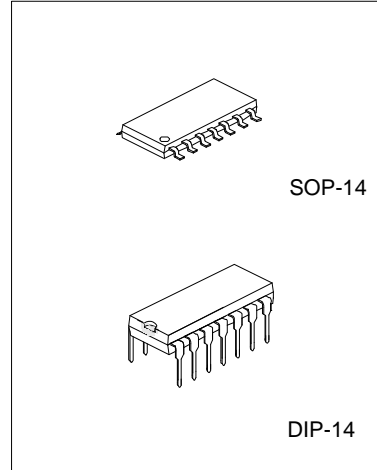

PIN CONFIGURATIONS

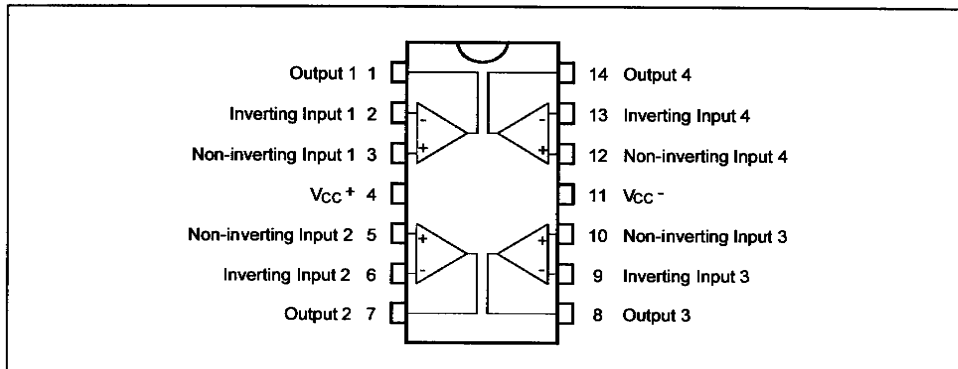

UTC TL074 LINEAR INTEGRATED CIRCUIT

SCHEMATIC DIAGRAM

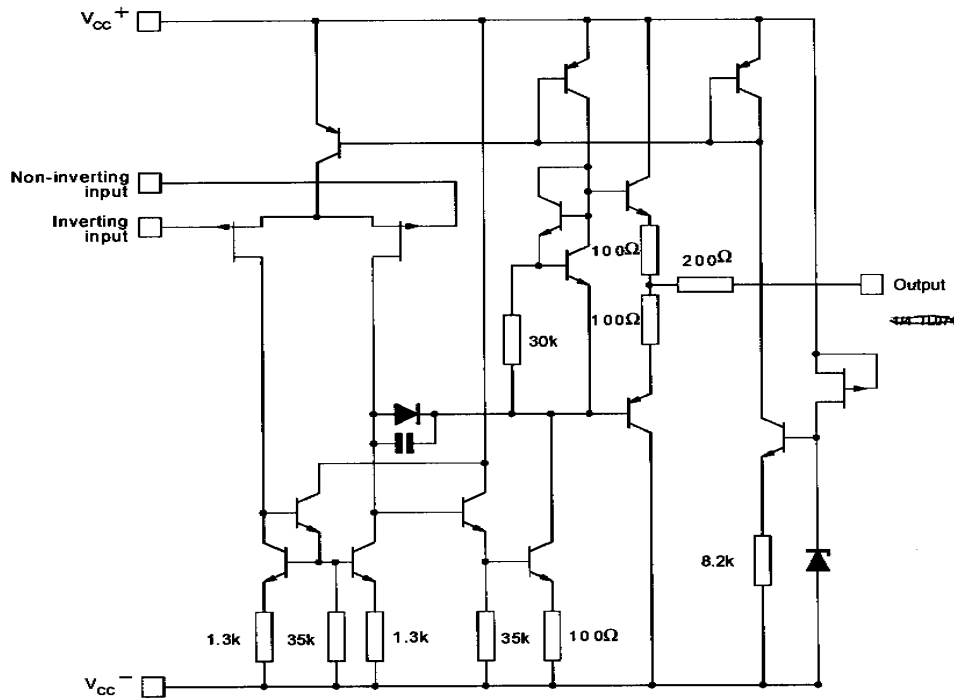

ABSOLUTE MAXIMUM RATINGS(Ta=25°C)

PARAMETER	SYMBOL	VALUE	UNIT
Supply Voltage (note 1)	Vcc	+18	V
Input Voltage (note 2)	Vi	+15	V
Differential Input Voltage (note 3)	Vid	+30	V
Power Dissipation	Ptot	680	mW
Output Short-Circuit Duration (Note 4)		Infinite	
Operating Free Air Temperature	Toper	0 to 70	°C
Storage Temperature	Tstg	5 to 150	°C

- NOTES:
1. All voltage values, except differential voltage, are with respect to the zero reference level (ground) of the supply voltages where the zero reference level is the midpoint between Vcc- and Vcc+.
 2. The magnitude of the input voltage must never exceed the magnitude of the supply voltage or 15 volts, whichever is less.
 3. Differential voltages are at the non-inverting input terminal with respect to the inverting input terminal.
 4. The output may be shorted to ground or to either supply. Temperature and/or supply voltages must be limited to ensure that the dissipation rating is not exceeded.

UTC TL074 LINEAR INTEGRATED CIRCUIT

UTC TL074C ELECTRICAL CHARACTERISTICS ($V_{CC}=\pm 15V$, $T_a=25^\circ C$, unless otherwise specified)

PARAMETER	SYMBOL	MIN	TYP	MAX	UNIT
Input Offset Voltage($R_s=50\Omega$, $T_a=25^\circ C$ $T_{min}\leq T_a\leq T_{max}$)	V_{io}		3	10 13	mV
Temperature Coefficient of Input Offset Voltage	D_{vio}		10		$\mu V/^\circ C$
Input Offset Current* $T_a=25^\circ C$ $T_{min}\leq T_a\leq T_{max}$	I_{io}		5	100 10	pA nA
Input Bias Current* $T_a=25^\circ C$ $T_{min}\leq T_a\leq T_{max}$	I_{ib}		30	200 20	pA nA
Input Common Mode Voltage	V_{icm}	+11	-12~+15		V
Output Voltage Swing($R_L=10k\Omega$) $T_a=25^\circ C$, $R_L=2k\Omega$, $T_a=25^\circ C$, $R_L=10k\Omega$ $T_{min}\leq T_a\leq T_{max}$, $R_L=2k\Omega$ $T_{min}\leq T_a\leq T_{max}$, $R_L=10k\Omega$	V_{opp}	10 12 10 12	12 13.5		V
Large Signal Voltage Gain($R_L=2k\Omega$, $V_o=\pm 10V$) $T_a=25^\circ C$ $T_{min}\leq T_a\leq T_{max}$	A_{vd}	25 15	200		V/mV
Gain Bandwidth Product($T_a=25^\circ C$, $R_L=10k\Omega$, $f=100kHz$, $V_{in}=10mV$, $C_L=100pF$)	GBP	2	3		MHz
Input Resistance	R_i		10^{12}		Ω
Common Mode Rejection Ratio($R_s=50\Omega$) $T_a=25^\circ C$ $T_{min}\leq T_a\leq T_{max}$	CMR	70 70	86		dB
Supply Voltage Rejection Ratio($R_s=50\Omega$) $T_a=25^\circ C$ $T_{min}\leq T_a\leq T_{max}$	SVR	70 70	86		dB
Supply Current(no load) $T_a=25^\circ C$ $T_{min}\leq T_a\leq T_{max}$	I_{cc}		1.4	2.5 2.5	mA
Channel Separation($A_v=100$, $T_a=25^\circ C$)	V_{o1}/V_{o2}		120		dB
Output Short-circuit Current $T_a=25^\circ C$ $T_{min}\leq T_a\leq T_{max}$	I_{os}	10 10	40	60 60	mA
Slew Rate($V_i=10V$, $R_L=2k\Omega$, $C_L=100pF$, $T_a=25^\circ C$, unity gain)	SR	8	13		V/ μs
Rise Time($V_i=20mV$, $R_L=2k\Omega$, $C_L=100pF$, $T_a=25^\circ C$, unity gain)	t_r		0.1		μs
Overshoot Factor($V_i=20mV$, $R_L=2k\Omega$, $C_L=100pF$, $T_a=25^\circ C$, unity gain)	K_{ov}		10		%
Total Harmonic Distortion($A_v=20dB$, $f=1kHz$ $R_L=2k\Omega$, $C_L=100pF$, $T_a=25^\circ C$, $V_o=2V_{pp}$)	THD		0.01		%
Phase Margin			45		Degrees
Equivalent Input Noise Voltage($R_s=100\Omega$, $f=1KHz$)	e_n		15		

*The Input bias currents are junction leakage currents, which approximately double for every $10^\circ C$ increase in the junction temperature.

UTC TL074 LINEAR INTEGRATED CIRCUIT

UTC TL074AC ELECTRICAL CHARACTERISTICS($V_{CC}=\pm 15V$, $T_a=25^\circ C$, unless otherwise specified)

PARAMETER	SYMBOL	MIN	TYP	MAX	UNIT
Input Offset Voltage($R_s=50\Omega$), $T_a=25^\circ C$ $T_{min}\leq T_a\leq T_{max}$	V_{io}		3	6 7	mV
Temperature Coefficient of Input Offset Voltage($R_s=50\Omega$)	D_{vio}		10		$\mu V/^\circ C$
Input Offset Current* $T_a=25^\circ C$ $T_{min}\leq T_a\leq T_{max}$	I_{io}		5	100 4	pA nA
Input Bias Current* $T_a=25^\circ C$ $T_{min}\leq T_a\leq T_{max}$	I_{ib}		20	200 20	pA nA
Input Common Mode Voltage	V_{icm}	+11	-12~+15		V
Output Voltage Swing($R_L=10k\Omega$) $T_a=25^\circ C$, $R_L=2k\Omega$, $T_a=25^\circ C$, $R_L=10k\Omega$ $T_{min}\leq T_a\leq T_{max}$, $R_L=2k\Omega$ $T_{min}\leq T_a\leq T_{max}$, $R_L=10k\Omega$	V_{opp}	10 12 10 12	12 13.5		V
Large Signal Voltage Gain($R_L=10k\Omega$, $V_o=\pm 10V$) $T_a=25^\circ C$ $T_{min}\leq T_a\leq T_{max}$	A_{vd}	50 25	200		V/mV
Gain Bandwidth Product($T_a=25^\circ C$, $R_L=10k\Omega$, $C_L=100pF$)	GBP	2	3		MHz
Input Resistance	R_i		10^{12}		Ω
Common Mode Rejection Ratio($R_s=50\Omega$) $T_a=25^\circ C$ $T_{min}\leq T_a\leq T_{max}$	CMR	80 80	86		dB
Supply Voltage Rejection Ratio($R_s=50\Omega$) $T_a=25^\circ C$ $T_{min}\leq T_a\leq T_{max}$	SVR	80 80	86		dB
Supply Current(no load) $T_a=25^\circ C$ $T_{min}\leq T_a\leq T_{max}$	I_{cc}		1.4	2.5 2.5	mA
Channel Separation($A_v=100$, $T_a=25^\circ C$)	V_{o1}/V_{o2}		120		dB
Output Short-circuit Current $T_a=25^\circ C$ $T_{min}\leq T_a\leq T_{max}$	I_{os}	10 10	40	60 60	mA
Slew Rate($V_i=10V$, $R_L=2k\Omega$, $C_L=100pF$, $T_a=25^\circ C$, unity gain)	SR	8	13		V/ μs
Rise Time($V_i=20mV$, $R_L=2k\Omega$, $C_L=100pF$, $T_a=25^\circ C$, unity gain)	t_r		0.1		μs
Overshoot Factor($V_i=20mV$, $R_L=2k\Omega$, $C_L=100pF$, $T_a=25^\circ C$, unity gain)	K_{ov}		10		%
Total Harmonic Distortion($A_v=20dB$, $f=1kHz$ $R_L=2k\Omega$, $C_L=100pF$, $T_a=25^\circ C$, $V_o=2V_{pp}$)	THD		0.01		%
Phase Margin			45		Degrees
Equivalent Input Noise Voltage($R_s=100\Omega$, $f=1KHz$)	e_n		15		

*The Input bias currents are junction leakage currents, which approximately double for every $10^\circ C$ increase in the junction temperature.

UTC TL074 LINEAR INTEGRATED CIRCUIT

UTC TL074BC ELECTRICAL CHARACTERISTICS($V_{CC}=\pm 15V$, $T_a=25^\circ C$, unless otherwise specified)

PARAMETER	SYMBOL	MIN	TYP	MAX	UNIT
Input Offset Voltage($R_s=50\Omega$), $T_a=25^\circ C$ $T_{min}\leq T_a\leq T_{max}$	V_{io}		1	3 5	mV
Temperature Coefficient of Input Offset Voltage($R_s=50\Omega$)	D_{vio}		10		$\mu V/^\circ C$
Input Offset Current* $T_a=25^\circ C$ $T_{min}\leq T_a\leq T_{max}$	I_{io}		5	100 4	pA nA
Input Bias Current* $T_a=25^\circ C$ $T_{min}\leq T_a\leq T_{max}$	I_{ib}		20	200 20	pA nA
Input Common Mode Voltage	V_{icm}	+11	-12~+15		V
Output Voltage Swing($R_L=10k\Omega$) $T_a=25^\circ C$, $R_L=2k\Omega$, $T_a=25^\circ C$, $R_L=10k\Omega$ $T_{min}\leq T_a\leq T_{max}$, $R_L=2k\Omega$ $T_{min}\leq T_a\leq T_{max}$, $R_L=10k\Omega$	V_{opp}	10 12 10 12	12 13.5		V
Large Signal Voltage Gain($R_L=10k\Omega$, $V_o=\pm 10V$) $T_a=25^\circ C$ $T_{min}\leq T_a\leq T_{max}$	A_{vd}	50 25	200		V/mV
Gain Bandwidth Product($T_a=25^\circ C$, $R_L=10k\Omega$, $C_L=100pF$)	GBP	2	3		MHz
Input Resistance	R_i		10^{12}		Ω
Common Mode Rejection Ratio($R_s=50\Omega$) $T_a=25^\circ C$ $T_{min}\leq T_a\leq T_{max}$	CMR	80 80	86		dB
Supply Voltage Rejection Ratio($R_s=50\Omega$) $T_a=25^\circ C$ $T_{min}\leq T_a\leq T_{max}$	SVR	80 80	86		dB
Supply Current(no load) $T_a=25^\circ C$ $T_{min}\leq T_a\leq T_{max}$	I_{cc}		1.4	2.5 2.5	mA
Channel Separation($A_v=100$, $T_a=25^\circ C$)	V_{o1}/V_{o2}		120		dB
Output Short-circuit Current $T_a=25^\circ C$ $T_{min}\leq T_a\leq T_{max}$	I_{os}	10 10	40	60 60	mA
Slew Rate($V_i=10V$, $R_L=2k\Omega$, $C_L=100pF$, $T_a=25^\circ C$, unity gain)	SR	8	13		V/ μs
Rise Time($V_i=20mV$, $R_L=2k\Omega$, $C_L=100pF$, $T_a=25^\circ C$, unity gain)	t_r		0.1		μs
Overshoot Factor($V_i=20mV$, $R_L=2k\Omega$, $C_L=100pF$, $T_a=25^\circ C$, unity gain)	K_{ov}		10		%
Total Harmonic Distortion($A_v=20dB$, $f=1kHz$ $R_L=2k\Omega$, $C_L=100pF$, $T_a=25^\circ C$, $V_o=2V_{pp}$)	THD		0.01		%
Phase Margin			45		Degrees
Equivalent Input Noise Voltage($R_s=100\Omega$, $f=1KHz$)	e_n		15		

*The Input bias currents are junction leakage currents, which approximately double for every $10^\circ C$ increase in the junction temperature.

UTC TL074 LINEAR INTEGRATED CIRCUIT

MAXIMUM PEAK-TO-PEAK OUTPUT VOLTAGE VERSUS FREQUENCY

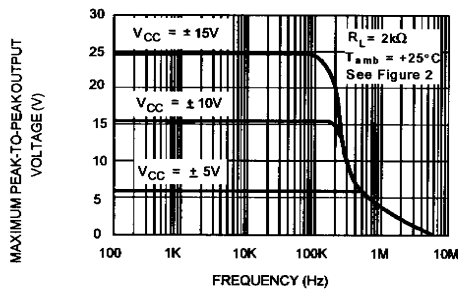

MAXIMUM PEAK-TO-PEAK OUTPUT VOLTAGE VERSUS FREQUENCY

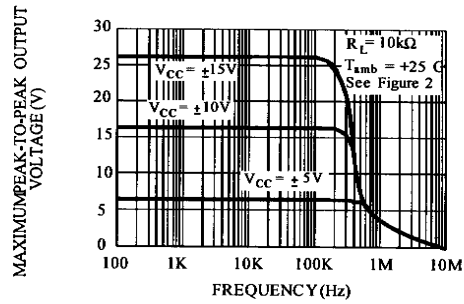

MAXIMUM PEAK-TO-PEAK OUTPUT VOLTAGE VERSUS FREQUENCY

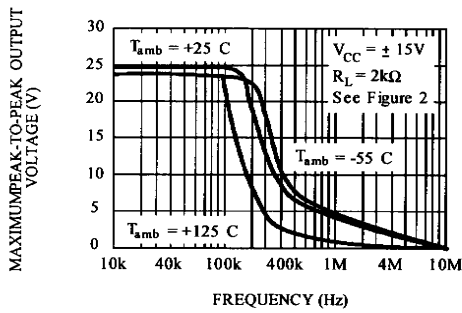

MAXIMUM PEAK-TO-PEAK OUTPUT VOLTAGE VERSUS FREE AIR TEMP.

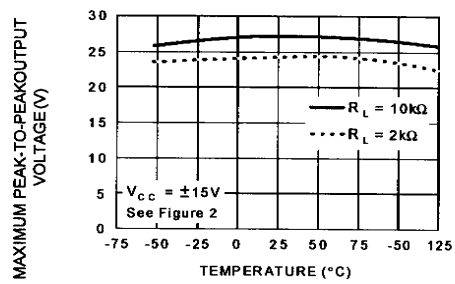

MAXIMUM PEAK-TO-PEAK OUTPUT VOLTAGE VERSUS LOAD RESISTANCE

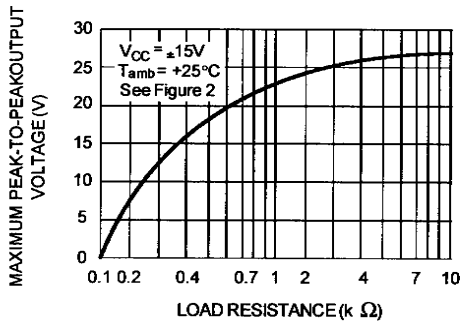

MAXIMUM PEAK-TO-PEAK OUTPUT VOLTAGE VERSUS SUPPLY VOLTAGE

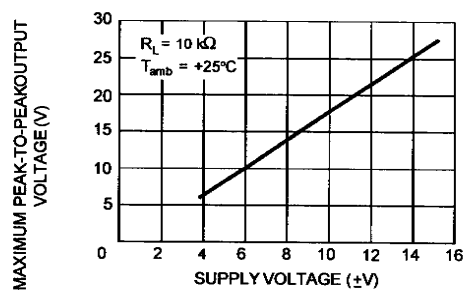

INPUT BIAS CURRENT VERSUS FREE AIR TEMPERATURE

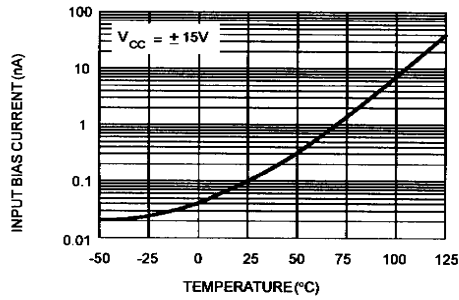

LARGE SIGNAL DIFFERENTIAL VOLTAGE AMPLIFICATION VERSUS FREE AIR TEMPERATURE

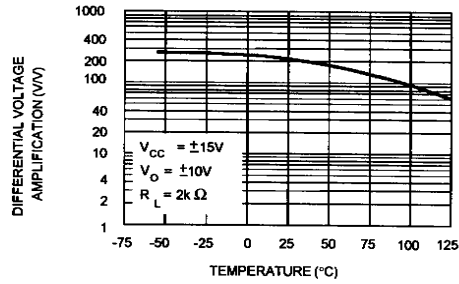

LARGE SIGNAL DIFFERENTIAL VOLTAGE AMPLIFICATION AND PHASE SHIFT VERSUS FREQUENCY

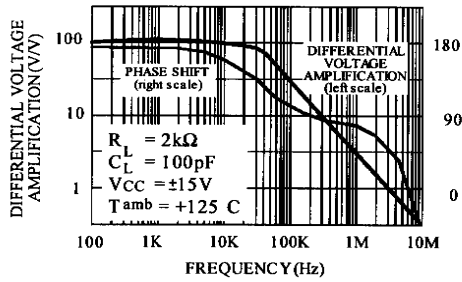

TOTAL POWER DISSIPATION VERSUS FREE AIR TEMPERATURE

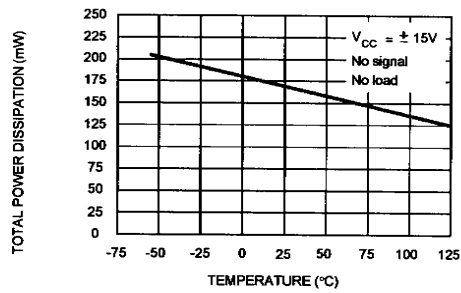

SUPPLY CURRENT PER AMPLIFIER VERSUS FREE AIR TEMPERATURE

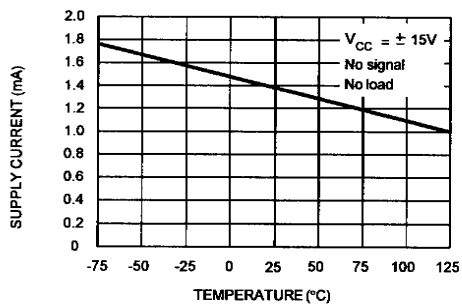

COMMON MODE REJECTION RATIO VERSUS FREE AIR TEMPERATURE

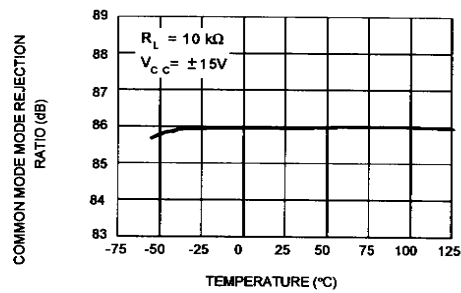

UTC TL074 LINEAR INTEGRATED CIRCUIT

VOLTAGE FOLLOWER LARGE SIGNAL PULSE RESPONSE

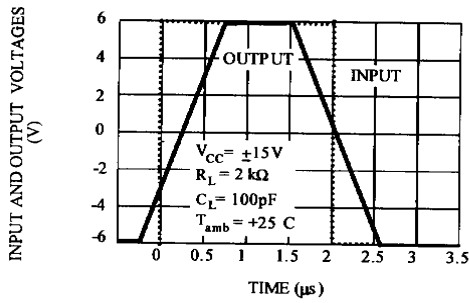

OUTPUT VOLTAGE VERSUS ELAPSED TIME

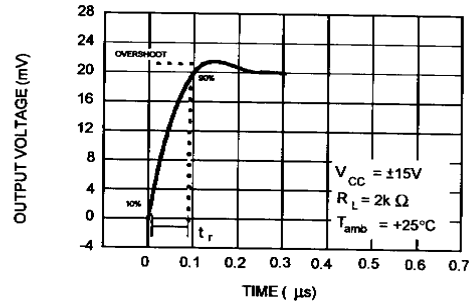

EQUIVALENT INPUT NOISE VOLTAGE VERSUS FREQUENCY

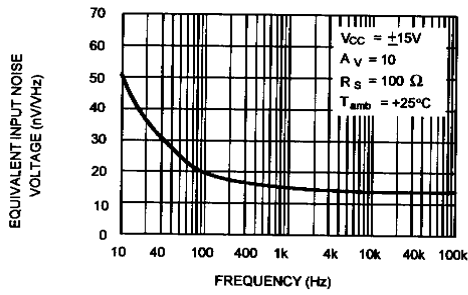

TOTAL HARMONIC DISTORTION VERSUS FREQUENCY

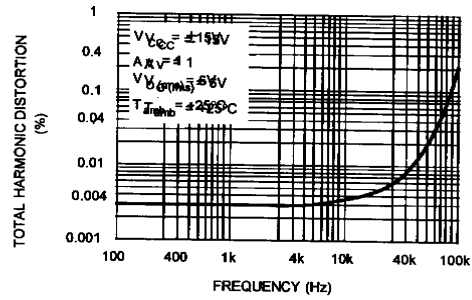

UTC TL074 LINEAR INTEGRATED CIRCUIT

PARAMETER MEASUREMENT INFORMATION

Figure 1 : Voltage Follower

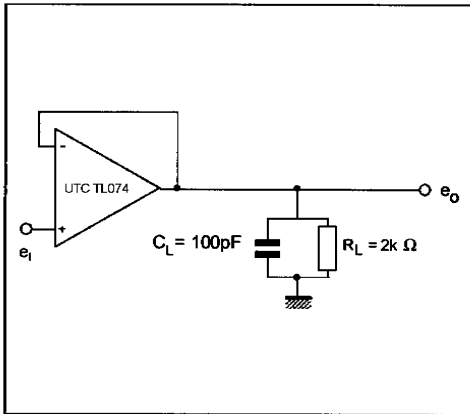
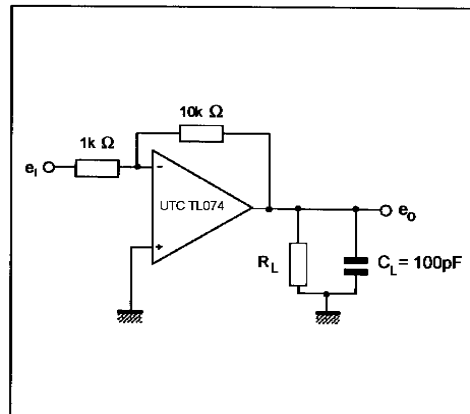

Figure 2 : Gain-of-10 Inverting Amplifier



TYPICAL APPLICATIONS

