

PHASE NOISE (1 Hz BW, typical)

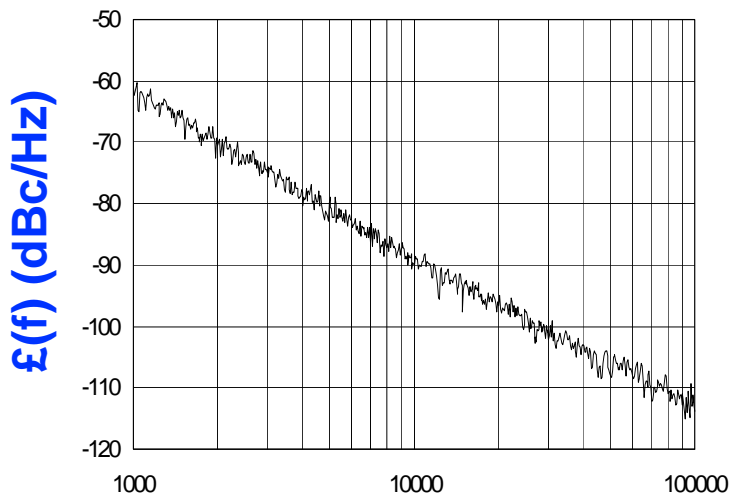

FEATURES

- Frequency Range: 3410 - 3665 MHz
- Tuning Voltage: 0.5-4.5 Vdc
- MINI-14S-L - Style Package

APPLICATIONS

- Direct Broadcast
- Satellite Up/Down Conversion
- Microwave Links

PERFORMANCE SPECIFICATIONS

	VALUE	UNITS
Oscillation Frequency Range	3410 - 3665	MHz
Phase Noise @ 10 kHz offset (1 Hz BW, typ.)	-90	dBc/Hz
Harmonic Suppression (2nd, typ.)	-15	dBc
Tuning Voltage	0.5-4.5	Vdc
Tuning Sensitivity (avg.)	87	MHz/V
Power Output	3±2	dBm
Load Impedance	50	Ω
Input Capacitance (max.)	50	pF
Pushing	<3	MHz/V
Pulling (14 dB Return Loss, Any Phase)	<8	MHz
Operating Temperature Range	-20 to 70	°C
Package Style	MINI-14S-L	

POWER SUPPLY REQUIREMENTS

Supply Voltage (Vcc, nom.)	5	Vdc
Supply Current (Icc, typ.)	16	mA

All specifications are typical unless otherwise noted and subject to change without notice.

APPLICATION NOTES

- AN-100/1 : Mounting and Grounding of VCOs
- AN-102 : Proper Output Loading of VCOs
- AN-107 : How to Solder Z-COMM VCOs

NOTES:

TUNING CURVE, typ.

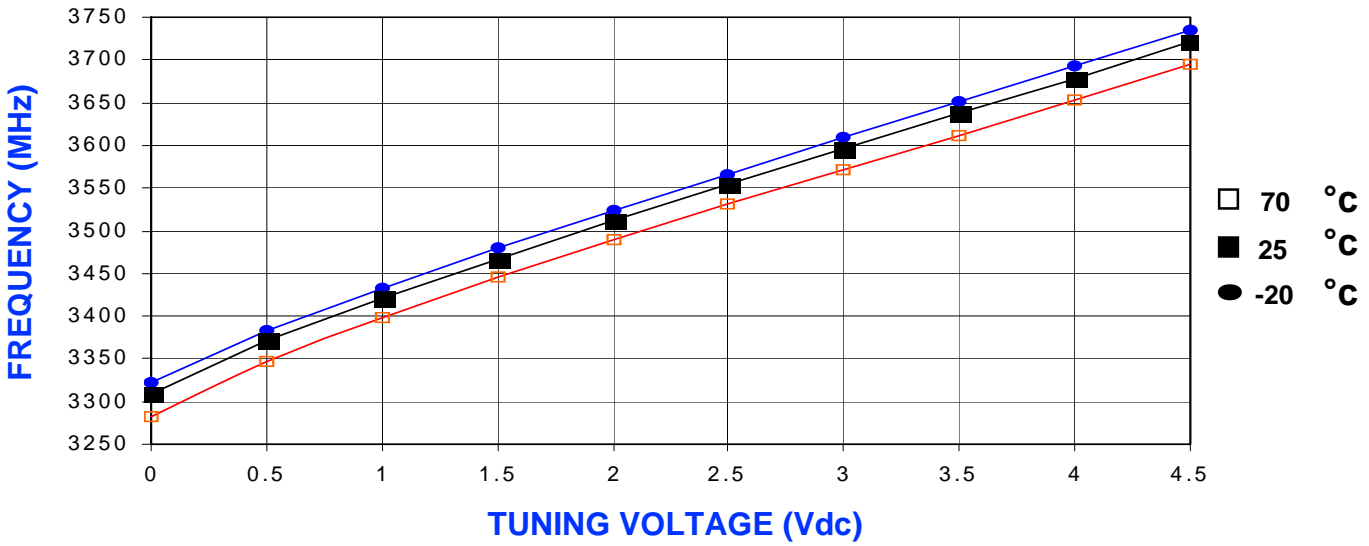

POWER CURVE, typ.

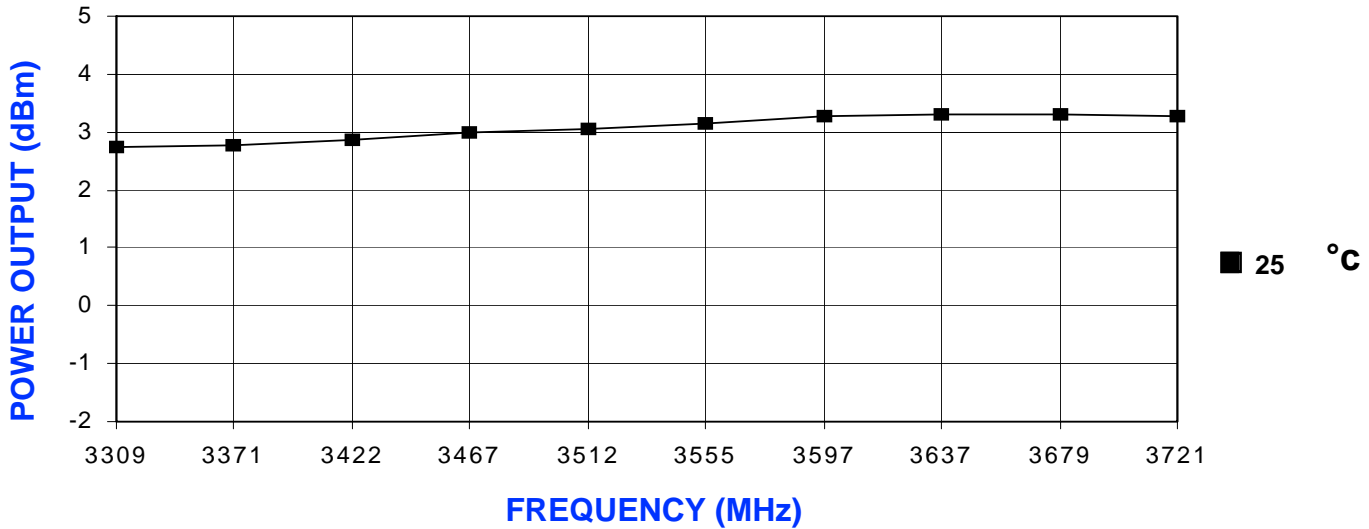

PHYSICAL DIMENSIONS

MINI-14S-L
415-0063 REV. B
(DRAWING NOT TO SCALE)

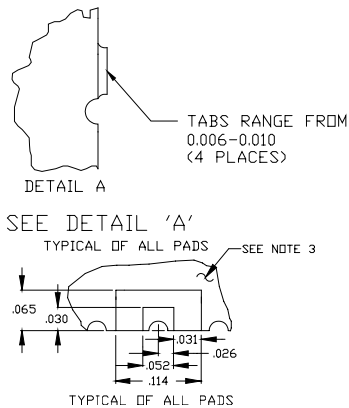
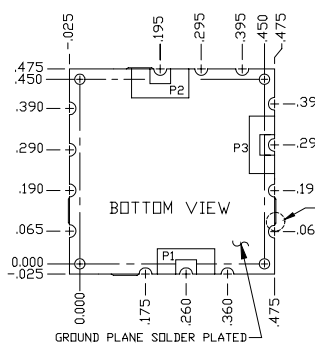

NOTES:

1. THE INSIDE RADIUS OF ALL 14 HALF HOLES AT THE PERIMETER OF THE BOARD ARE SOLDER PLATED TO PROVIDE A SURFACE FOR THE ATTACHMENT OF THE VCO TO A MOTHERBOARD. IN 11 LOCATIONS, WITH 3 PADS BEING USED FOR ELECTROMECHANICAL INTERFACE. 14 SOLDER LOCATIONS REQUIRED.
2. THE SURFACE OF THE SHIELD IS TIN PLATED AND MAY BE SOLDERED TO THE SHIELD'S BASE METAL IS BRASS.
3. THE GROUND PLANE IS GROUND AND ATTACHES TO A GROUND TRACK ON THE UPPER SIDE OF THE BOARD AS WELL AS THE SHIELD BY PTH.
4. UNLESS OTHERWISE NOTED ALL DIMENSIONS ARE IN INCHES.
5. UNLESS OTHERWISE NOTED ALL TOLERANCES ARE AS FOLLOWS:
TOLERANCES
.XXX= ± .010

P1=VT
P2=RF OUT
P3=VCC