

Power MOSFET Stage for Boost Converters

Module for Power Factor Correction

$I_{D25} = 47 \text{ A}$
 $V_{DSS} = 500 \text{ V}$
 $R_{DS(on)} = 0.12 \Omega$

V_{RRM} (Diode) V	V_{DSS} V	Type
600	500	VUM 33-05N

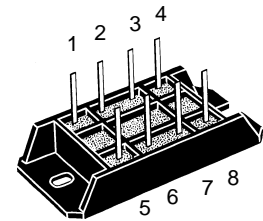
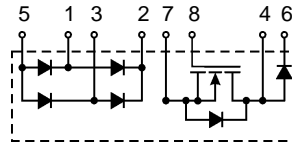

Symbol	Test Conditions	Maximum Ratings	
V_{DSS}	$T_{VJ} = 25^{\circ}\text{C}$ to 150°C	500	V
V_{DGR}	$T_{VJ} = 25^{\circ}\text{C}$ to 150°C ; $R_{GS} = 10 \text{ k}\Omega$	500	V
V_{GS}	Continuous	± 20	V
I_D	MOSFET $T_S = 85^{\circ}\text{C}$	33	A
I_D		47	A
I_{DM}		130	A
P_D	$T_S = 85^{\circ}\text{C}$	310	W
I_S	$V_{GS} = 0 \text{ V}$, $T_S = 25^{\circ}\text{C}$	33	A
I_{SM}		$V_{GS} = 0 \text{ V}$, $T_S = 25^{\circ}\text{C}$, $t_p = \text{①}$	130
V_{RRM}	Boost Diode $T_S = 85^{\circ}\text{C}$, rectangular $\delta = 0.5$	600	V
I_{FAV}		33	A
I_{FSM}	$T_{VJ} = 45^{\circ}\text{C}$, $t = 10 \text{ ms}$ (50 Hz) $t = 8.3 \text{ ms}$ (60 Hz)	300	A
		320	A
	$T_{VJ} = 150^{\circ}\text{C}$, $t = 10 \text{ ms}$ (50 Hz) $t = 8.3 \text{ ms}$ (60 Hz)	260	A
		280	A
P	$T_S = 85^{\circ}\text{C}$	59	W
V_{RRM}	Rectifier Diodes $T_S = 85^{\circ}\text{C}$, sinus 180°	800	V
I_{dAV}		54	A
I_{FSM}	$T_{VJ} = 45^{\circ}\text{C}$, $t = 10 \text{ ms}$ (50 Hz) $t = 8.3 \text{ ms}$ (60 Hz)	300	A
		320	A
	$T_{VJ} = 150^{\circ}\text{C}$, $t = 10 \text{ ms}$ (50 Hz) $t = 8.3 \text{ ms}$ (60 Hz)	260	A
		280	A
P	$T_S = 85^{\circ}\text{C}$	50	W
T_{VJ}	Module	-40...+150	$^{\circ}\text{C}$
T_{JM}		150	$^{\circ}\text{C}$
T_{stg}		-40...+150	$^{\circ}\text{C}$
V_{ISOL}	50/60 Hz $I_{ISOL} \leq 1 \text{ mA}$	$t = 1 \text{ min}$ 3000	V~
		$t = 1 \text{ s}$ 3600	V~
M_d Weight	Mounting torque (M5)	2-2.5/18-22 Nm/lb.in. 28	g

Features

- Package with DCB ceramic base plate
- Soldering connections for PCB mounting
- Isolation voltage 3600 V~
- Low $R_{DS(on)}$ HDMOS™ process
- Low package inductance for high speed switching
- Ultrafast boost diode
- Kelvin source for easy drive

Applications

- Power factor pre-conditioner for SMPS, UPS, battery chargers and inverters
- Boost topology for SMPS including 1~ rectifier bridge
- Power supply for welding equipment

Advantages

- 3 functions in one package
- Output power up to 8 kW
- No external isolation
- Easy to mount with two screws
- Suitable for wave soldering
- High temperature and power cycling capability
- Fits easily to all available PFC controller ICs

① Pulse width limited by T_{VJ}
 IXYS reserves the right to change limits, test conditions and dimensions.

Symbol	Test Conditions	Characteristic Values ($T_{VJ} = 25^{\circ}\text{C}$, unless otherwise specified)		
		min.	typ.	max.
V_{DSS}	$V_{GS} = 0\text{ V}, I_D = 2\text{ mA}$	500		V
$V_{GS(th)}$	$V_{DS} = 20\text{ V}, I_D = 20\text{ mA}$	2		V
I_{GSS}	$V_{GS} = \pm 20\text{ V}, V_{DS} = 0\text{ V}$			± 500 nA
I_{DSS}	$V_{DS} = 500\text{ V}, V_{GS} = 0\text{ V}$			2 mA
$R_{DS(on)}$	$T_{VJ} = 25^{\circ}\text{C}$			0.12 Ω
R_{Gint}	$T_{VJ} = 25^{\circ}\text{C}$			1.5 Ω
g_{fs}	$V_{DS} = 15\text{ V}, I_{DS} = 12\text{ A}$	30		S
V_{DS}	$I_{DS} = 24\text{ A}, V_{GS} = 0\text{ V}$			1.5 V
$t_{d(on)}$	$V_{DS} = 250\text{ V}, I_{DS} = 12\text{ A}, V_{GS} = 10\text{ V}$ $Z_{gen.} = 1\ \Omega, \text{ L-load}$			100 ns
$t_{d(off)}$				220 ns
C_{iss}	$V_{DS} = 25\text{ V}, f = 1\text{ MHz}, V_{GS} = 0\text{ V}$		8.5	nF
C_{oss}			0.9	nF
C_{rss}			0.3	nF
Q_g	$V_{DS} = 250\text{ V}, I_D = 12\text{ A}, V_{GS} = 10\text{ V}$	350		nC
R_{thJS}				0.21 K/W
V_F	$I_F = 33\text{ A}; T_{VJ} = 25^{\circ}\text{C}$ $T_{VJ} = 150^{\circ}\text{C}$			1.75 V 1.5 V
I_R	$V_R = 600\text{ V}, T_{VJ} = 25^{\circ}\text{C}$ $V_R = 480\text{ V}, T_{VJ} = 25^{\circ}\text{C}$ $T_{VJ} = 125^{\circ}\text{C}$			1.5 mA 0.25 mA 7 mA
V_{T0}	For power-loss calculations only			1.21 V
r_T	$T_{VJ} = 125^{\circ}\text{C}$			9 m Ω
I_{RM}	$I_F = 30\text{ A}; -di_F/dt = 240\text{ A}/\mu\text{s}$ $V_R = 350\text{ V}, T_{VJ} = 100^{\circ}\text{C}$	10		11 A
R_{thJS}				1.1 K/W
V_F	$I_F = 20\text{ A}, T_{VJ} = 25^{\circ}\text{C}$ $T_{VJ} = 125^{\circ}\text{C}$			1.5 V 1.5 V
I_R	$V_R = 800\text{ V}, T_{VJ} = 25^{\circ}\text{C}$ $V_R = 640\text{ V}, T_{VJ} = 125^{\circ}\text{C}$			0.25 mA 2 mA
V_{T0}	For power-loss calculations only			1.18 V
r_T	$T_{VJ} = 125^{\circ}\text{C}$			12 m Ω
R_{thJS}				1.3 K/W

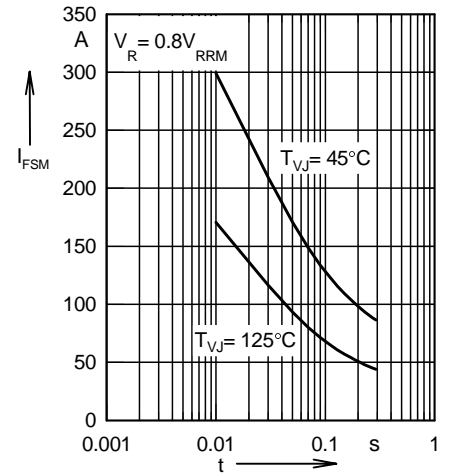

Fig. 1 Non-repetitive peak surge current (Rectifier Diodes)

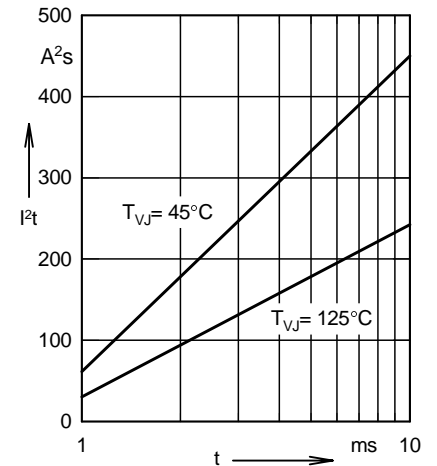
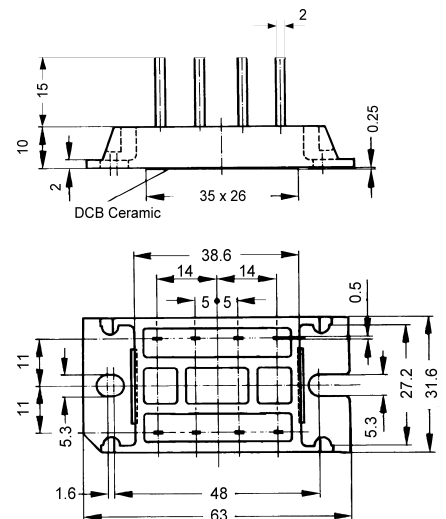

Fig. 2 I^2t for fusing (Rectifier Diodes)

Dimensions in mm (1 mm = 0.0394")



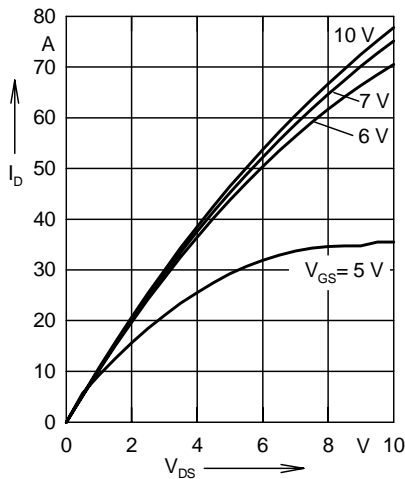

Fig. 3 Typ. output characteristic $I_D = f(V_{DS})$ (MOSFET)

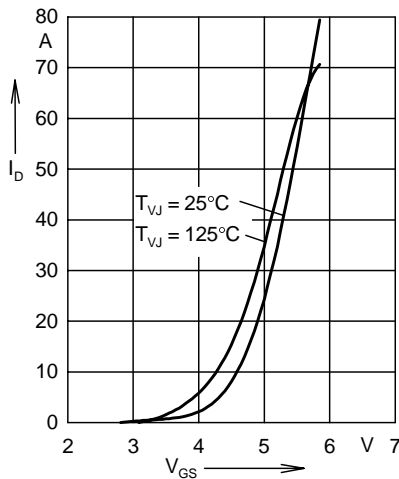

Fig. 4 Typ. transfer characteristics $I_D = f(V_{GS})$ (MOSFET)

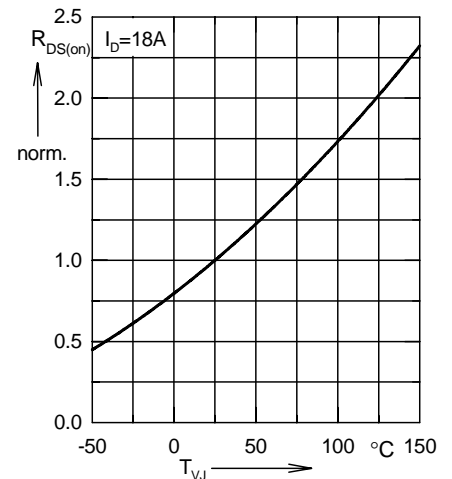

Fig. 5 Typ. normalized $R_{DS(on)} = f(T_{VJ})$ (MOSFET)

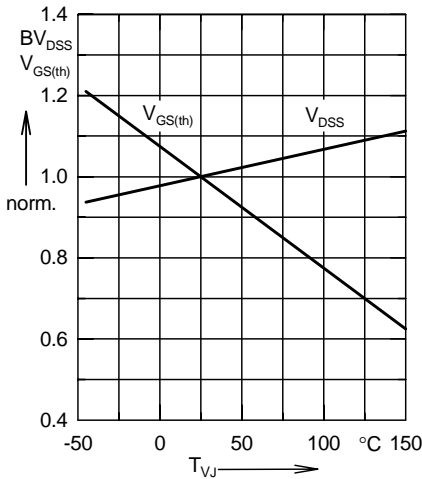

Fig. 6 Typ. normalized $BV_{DSS} = f(T_{VJ})$
 $V_{GS(th)} = f(T_{VJ})$ (MOSFET)

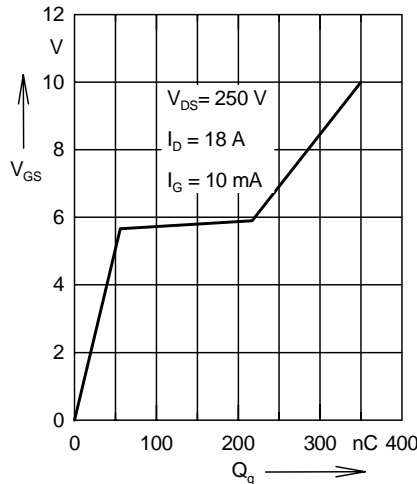

Fig. 7 Typ. turn-on gate charge characteristics, $V_{GS} = f(Q_g)$ (MOSFET)

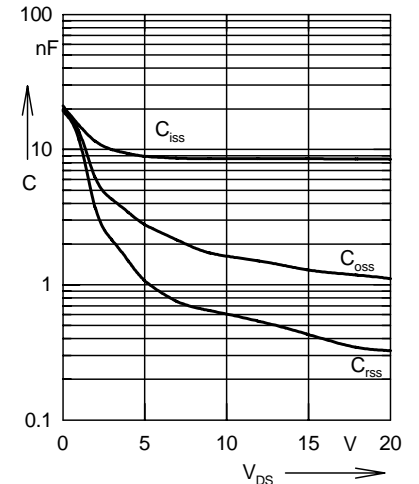

Fig. 8 Typ. capacitances $C = f(V_{DS})$, $f = 1 \text{ MHz}$ (MOSFET)

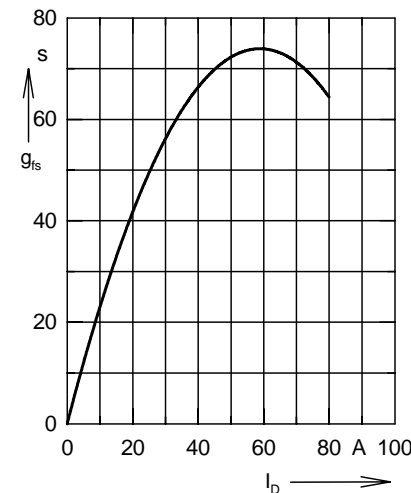

Fig. 9 Typ. transconductance, $g_{fs} = f(I_D)$ (MOSFET)

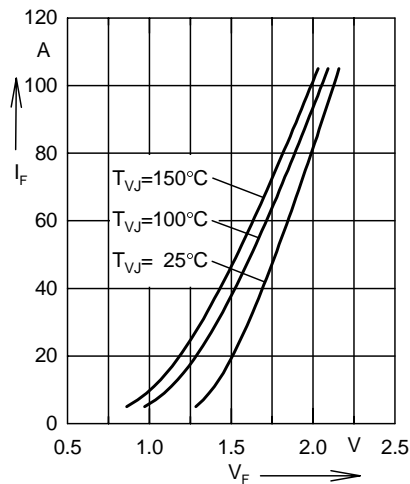

Fig. 10 Forward current versus voltage drop (Boost Diode)

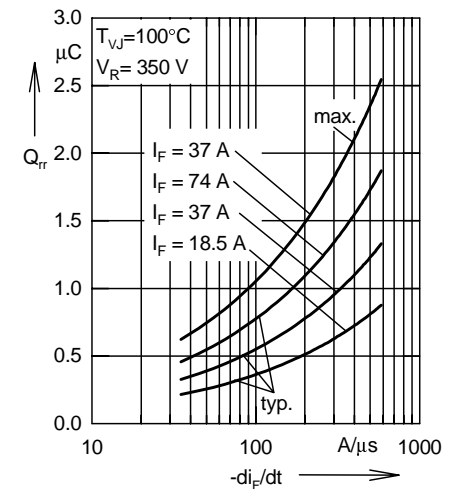

Fig. 11 Recovery charge versus $-di_F/dt$ (Boost Diode)

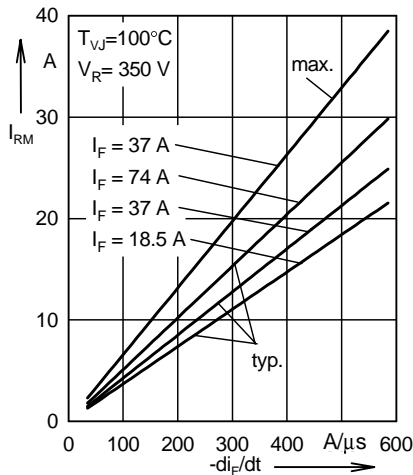

Fig. 12 Peak reverse current versus $-di_F/dt$ (Boost Diode)

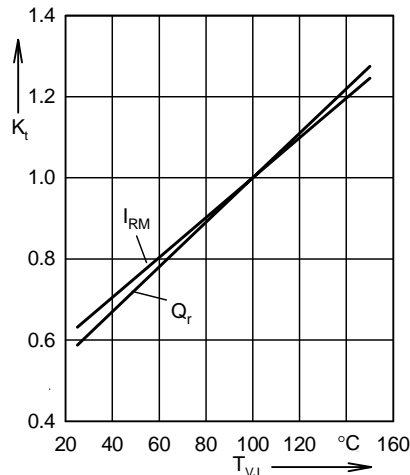

Fig. 13 Dynamic parameters versus junction temperature (Boost Diode)

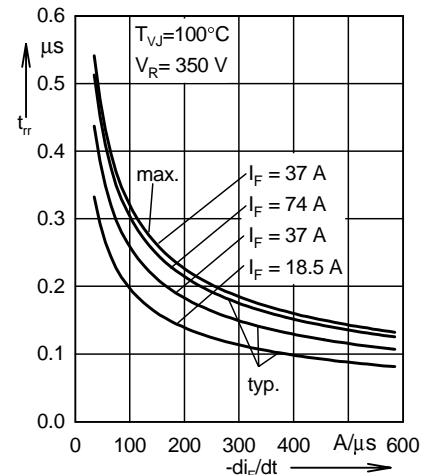

Fig. 14 Recovery time versus $-di_F/dt$ (Boost Diode)

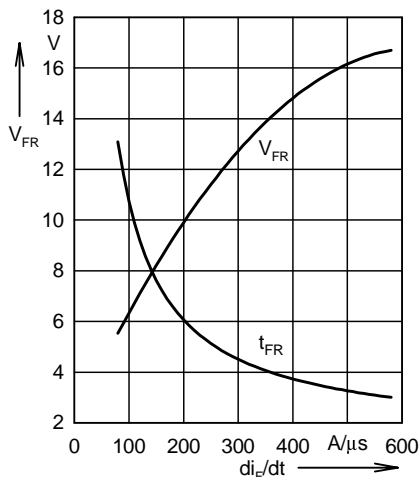

Fig. 15 Peak forward voltage versus $-di_F/dt$ (Boost Diode)

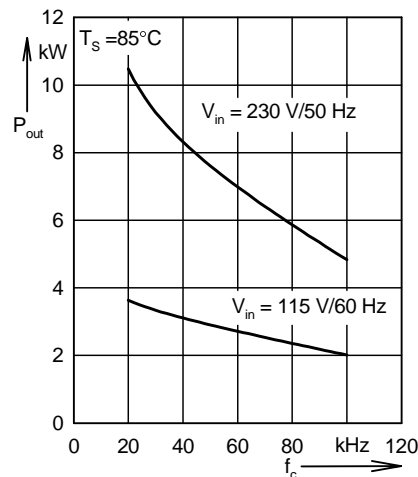

Fig. 16 Output power versus carrier frequency (Module)

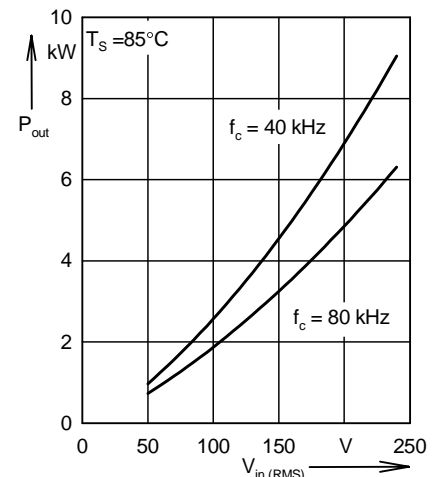

Fig. 17 Output power versus mains voltage

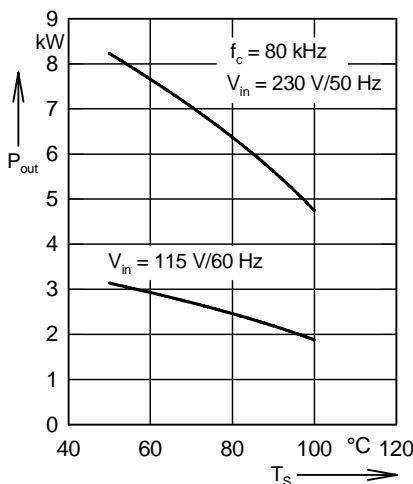

Fig. 18 Output power versus heatsink temperature (Module)

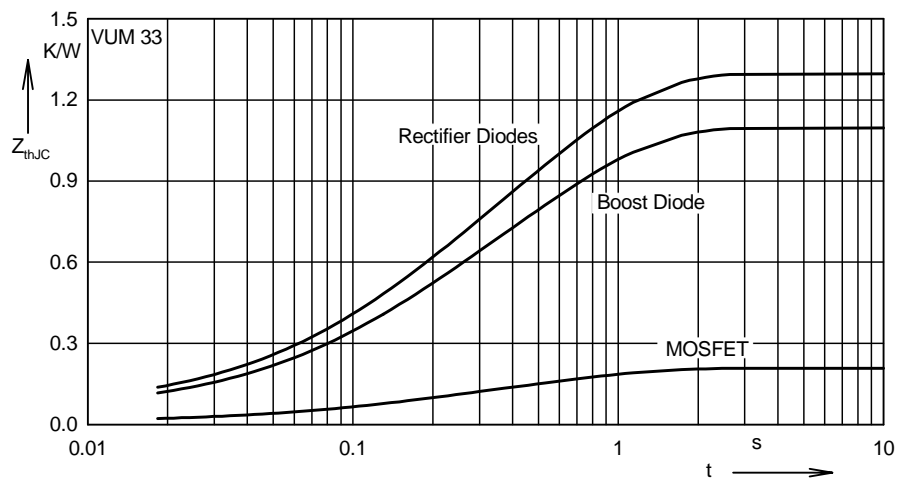

Fig. 19 Transient thermal impedance junction to case for all devices