

Part Number: WP59GYC

Green
Yellow

Features

- UNIFORM LIGHT OUTPUT.
- LOW POWER CONSUMPTION.
- 3 LEADS WITH ONE COMMON LEAD.
- I.C. COMPATIBLE.
- LONG LIFE-SOLID STATE RELIABILITY.
- RoHS COMPLIANT.

Description

The Green source color devices are made with Gallium Phosphide Green Light Emitting Diode.

The Yellow source color devices are made with Gallium Arsenide Phosphide on Gallium Phosphide Yellow Light Emitting Diode.

Package Dimensions

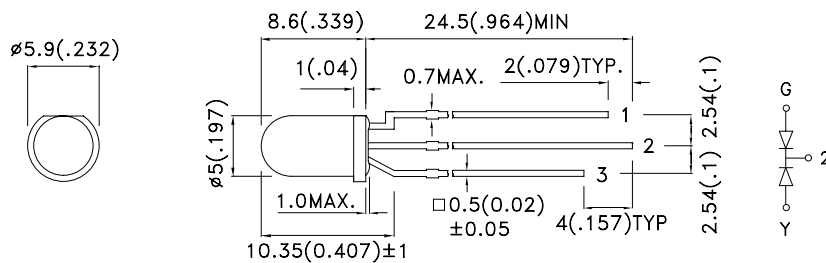

- 1 ANODE GREEN
- 2 COMMON CATHODE
- 3 ANODE YELLOW

Notes:

1. All dimensions are in millimeters (inches).
2. Tolerance is ±0.25(0.01") unless otherwise noted.
3. Lead spacing is measured where the leads emerge from the package.
4. Specifications are subject to change without notice.



Selection Guide

Part No.	Dice	Lens Type	Iv (mcd) [2] @ 20mA		Viewing Angle [1]
			Min.	Typ.	2 θ 1/2
WP59GYC	Green (GaP)	WATER CLEAR	70	150	24°
	Yellow (GaAsP/GaP)		18	60	

Notes:

1. θ 1/2 is the angle from optical centerline where the luminous intensity is 1/2 the optical centerline value.
2. Luminous intensity/ luminous Flux: +/-15%.

Electrical / Optical Characteristics at TA=25°C

Symbol	Parameter	Device	Typ.	Max.	Units	Test Conditions
λ_{peak}	Peak Wavelength	Green Yellow	565 590		nm	I _F =20mA
λ_D [1]	Dominant Wavelength	Green Yellow	568 588		nm	I _F =20mA
$\Delta\lambda_{1/2}$	Spectral Line Half-width	Green Yellow	30 35		nm	I _F =20mA
C	Capacitance	Green Yellow	15 20		pF	V _F =0V;f=1MHz
V _F [2]	Forward Voltage	Green Yellow	2.2 2.1	2.5 2.5	V	I _F =20mA
I _R	Reverse Current	Green Yellow		10 10	uA	V _R = 5V

Notes:

1. Wavelength: +/-1nm.
2. Forward Voltage: +/-0.1V.

Absolute Maximum Ratings at TA=25°C

Parameter	Green	Yellow	Units
Power dissipation	62.5	75	mW
DC Forward Current	25	30	mA
Peak Forward Current [1]	140	140	mA
Reverse Voltage	5		V
Operating / Storage Temperature	-40°C To +85°C		
Lead Solder Temperature [2]	260°C For 3 Seconds		
Lead Solder Temperature [3]	260°C For 5 Seconds		

Notes:

1. 1/10 Duty Cycle, 0.1ms Pulse Width.
2. 2mm below package base.
3. 5mm below package base.

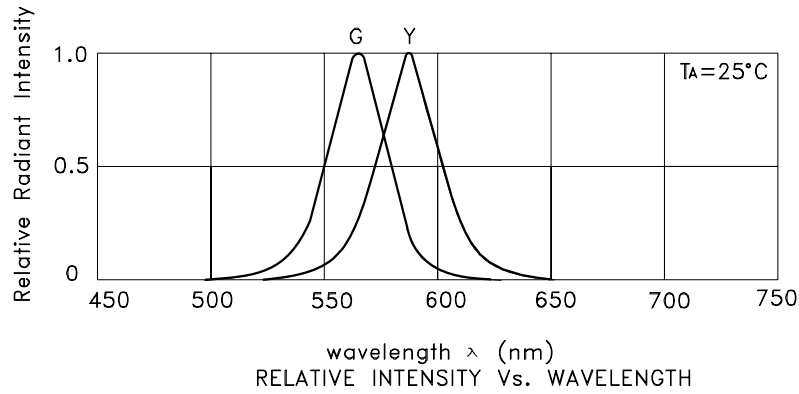

WP59GYC Green

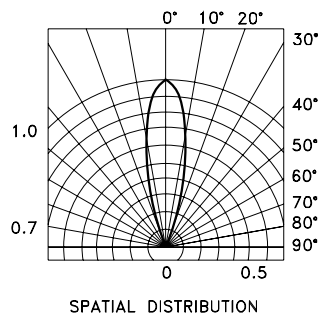
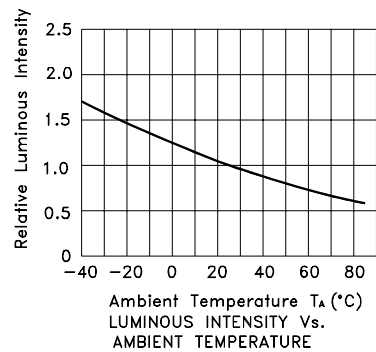
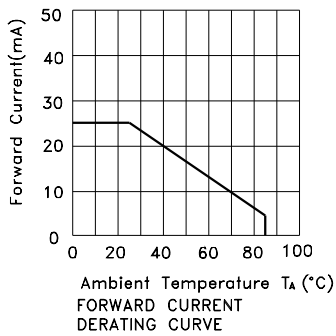
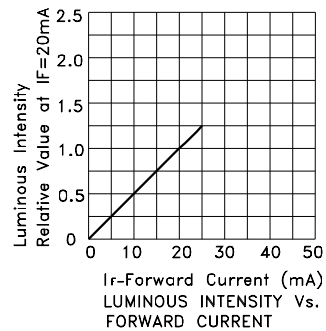
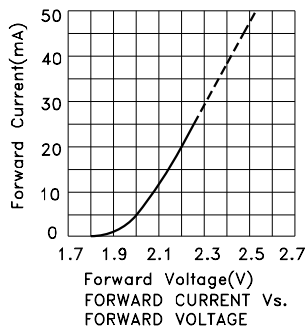

Kingbright

Yellow

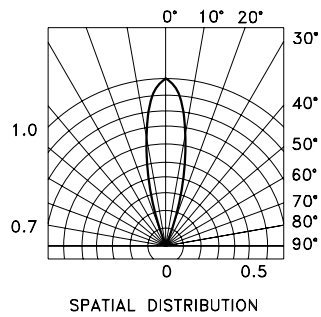
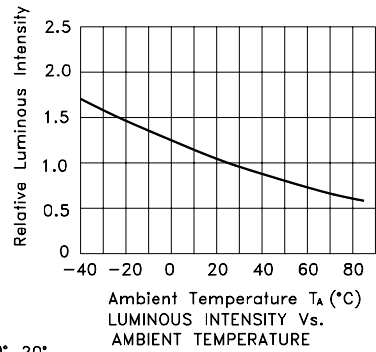
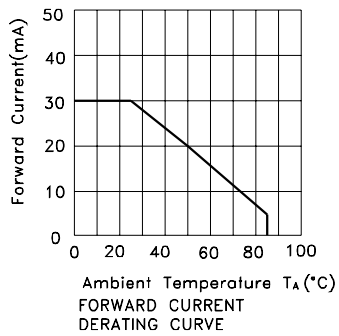
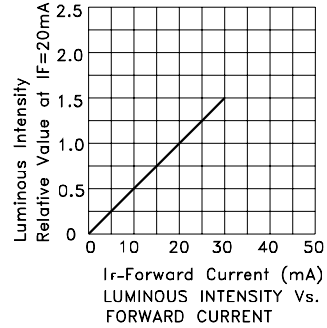
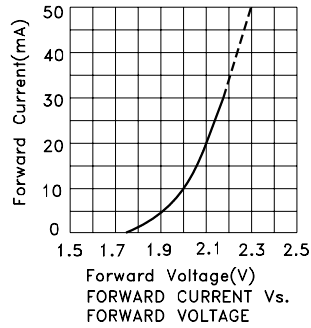

PACKING & LABEL SPECIFICATIONS

WP59GYC

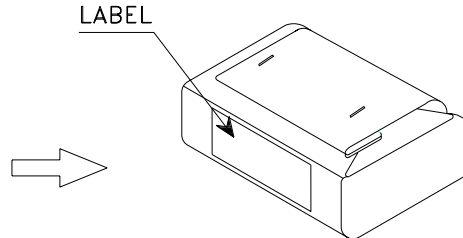
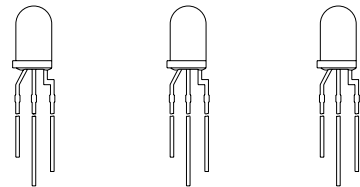

500PCS / BAG



28K / 9# BOX

OUTSIDE LABEL

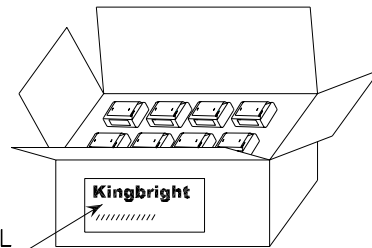
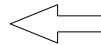

OUTSIDE LABEL

14K / 5# BOX

<h1>Kingbright</h1>				
Q.C.	<table border="1"> <tr> <td style="text-align: center;">QC</td> </tr> <tr> <td style="text-align: center;">XX XX XX</td> </tr> <tr> <td style="text-align: center;">PASSED</td> </tr> </table>	QC	XX XX XX	PASSED
QC				
XX XX XX				
PASSED				
TYPE NO : WP59xxx				
QUANTITY : 500 pcs				
S/N : XX	CODE: XX			
LOT NO : 				
RoHS Compliant				

LED MOUNTING METHOD

1. The lead pitch of the LED must match the pitch of the mounting holes on the PCB during component placement. Lead-forming may be required to insure the lead pitch matches the hole pitch. Refer to the figure below for proper lead forming procedures.

(Fig. 1)

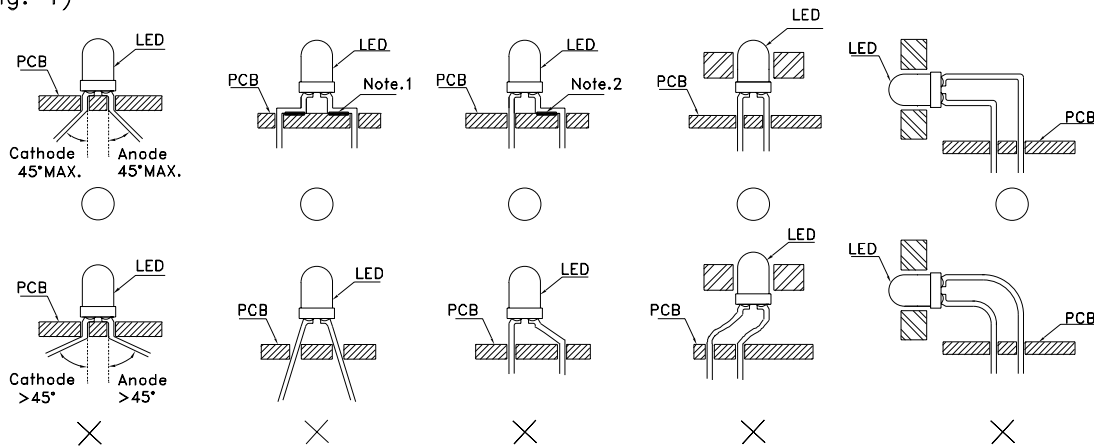

Fig.1

”O” Correct mounting method ”X” Incorrect mounting method

Note 1-2 : Do not route PCB trace in the contact area between the leadframe and the PCB to prevent short-circuits.

2. When soldering wire to the LED, use individual heat-shrink tubing to insulate the exposed leads to prevent accidental contact short-circuit.

(Fig. 2)

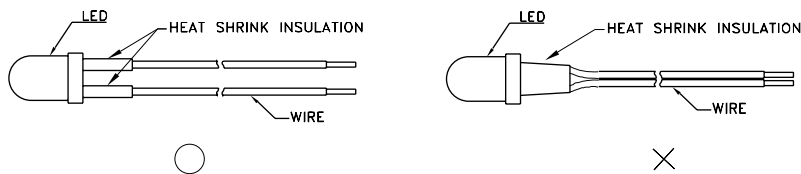

Fig. 2

3. Use stand-offs (Fig. 3) or spacers (Fig. 4) to securely position the LED above the PCB.

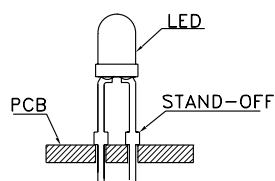

Fig. 3

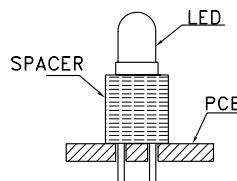

Fig. 4

LEAD FORMING PROCEDURES

1. Maintain a minimum of 2mm clearance between the base of the LED lens and the first lead bend. (Fig. 5 and 6)

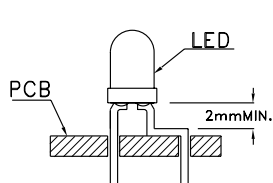

Fig. 5

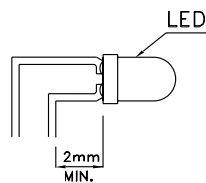

Fig. 6

2. Lead forming or bending must be performed before soldering, never during or after Soldering.
3. Do not stress the LED lens during lead-forming in order to fractures in the lens epoxy and damage the internal structures.
4. During lead forming, use tools or jigs to hold the leads securely so that the bending force will not be transmitted to the LED lens and its internal structures. Do not perform lead forming once the component has been mounted onto the PCB. (Fig. 7)
5. Do not bend the leads more than twice. (Fig. 8)

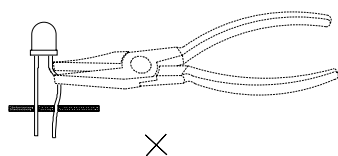

Fig. 7

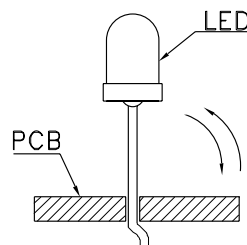

Fig. 8

6. After soldering or other high-temperature assembly, allow the LED to cool down to 50°C before applying outside force (Fig. 9). In general, avoid placing excess force on the LED to avoid damage. For any questions please consult with Kingbright representative for proper handling procedures.

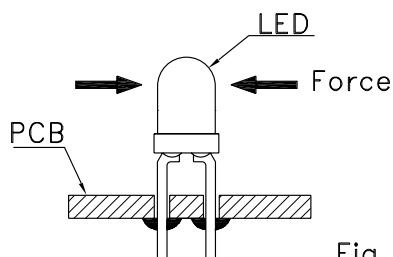

Fig. 9