

AKD4396-SBW

Evaluation board

General Description

The AKD4396-SBW is an evaluation board for AK4396, which is 192kHz sampling 24Bit $\Delta\Sigma$ DAC. The AKD4396-SBW includes a LPF which can add differential analog outputs from the AK4396 and also has a digital interface. Therefore, it is easy to evaluate the AK4396.

■ **Ordering Guide**

AKD4396-SBW --- Evaluation board for AK4396

Function

- On-board Analog output buffer circuit
- On-board digital audio interface. (AK4113)

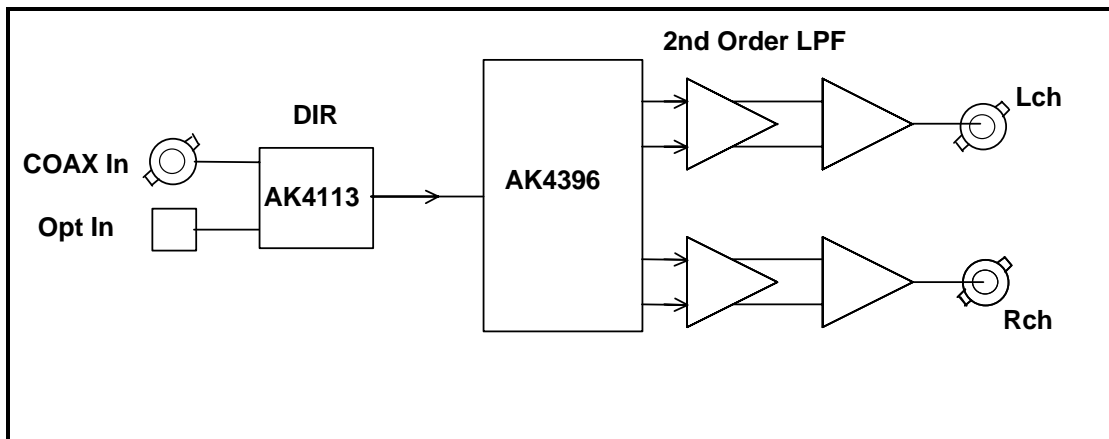

Figure 1 Block diagram

* Circuit diagram and PCB layout are attached at the end of this manual.

COAX is recommended for an evaluation of the Sound quality.

■ Operation sequence

1) Set up the power supply lines. (See “Other jumpers set-up”.)

Name	Color	Voltage	Comments	Attention
+15V	Red	+12~+15V	Regulator, Power supply for Op-amp.	This jack is always needed. Power line
-15V	Blue	-12~-15V	Regulator, Power supply for Op-amp.	This jack is always needed. Power line
AGND	Black	0V	GND	This jack is always needed.

Table 1 Set up of power supply lines

Each supply line should be distributed from the power supply unit.

2) Set-up the jumper pins

3) Set-up the DIP switches. (See the followings.)

4) Power on

The AK4396 should be reset once bringing SW1 (PDN) “L” upon power-up.

■ Evaluation mode

1. DIR(COAX) (default)

J1 is used for the evaluation using such as CD test disk. The DIR generates MCLK, BICK and LRCK SDATA from the received data through BNC connector (J1). Setting of jumper is shown below.

COAX is recommended for an evaluation of the Sound quality.

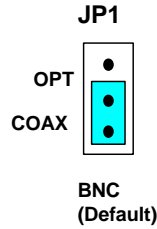

Figure 2 Jumper setting, when using DIR

2. DIR(Optical Link)

PORT1 is used for the evaluation using such as CD test disk. The DIR generates MCLK, BICK and LRCK SDATA from the received data through optical connector (PORT2: TORX176). Setting of jumper is shown below.

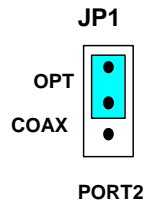

Figure 3 Jumper setting, when using DIR

3. All clocks are fed through the PORT1.

- R9, R12, R13, R14 : open
- R10, R15, R19, R20 : 100Ω or short (0 Ω)

■ DIP Switch setting

[SW2]: AK4113 setting

No.	Pin	OFF	ON	Default
1	OCKS1	AK4113 Master Clock setting		ON
2	OCKS0	Refer to Table4		OFF

Table 2 SW2 setting

[SW3]: AK4396 setting

No.	Pin	OFF	ON	Default
1				-
2	P/S	Serial mode (Note)	Parallel mode	ON

Note : When using the serial mode, R5 and R17 should be removed.

Table 3 SW3 setting

The frequency of the master clock output is set by OCKS0 and OCKS1 as shown in Table 4.

OCKS1	OCKS0	MCLK Frequency	Default
0	0	256fs @fs=88.2/96kHz	
1	0	512fs @32/44.1/48kHz	
1	1	128fs @176.4/192kHz	

Table 4 MCLK Clock

■ SW1 setting

[SW1](PDN): Reset of AK4396. Select “H” during operation.

■ External Analog Circuit

The differential output circuit and LPF is implemented on board. The differential outputs of AK4396 is buffered by non-inverted circuit(2nd order LPF, $f_c=182k$, $Q=0.637$, $G=+3.9dB$). LPF adds differential outputs(1st order LPF, $f_c=284k$, $G=-0.84dB$). NJM5534D is used for op-amp on this board that has low noise and high voltage tolerance characteristics. Analog signal is output via BNC connectors on the board. The output level is about 2.8Vrms (typ@VREF=5.0V) by BNC.

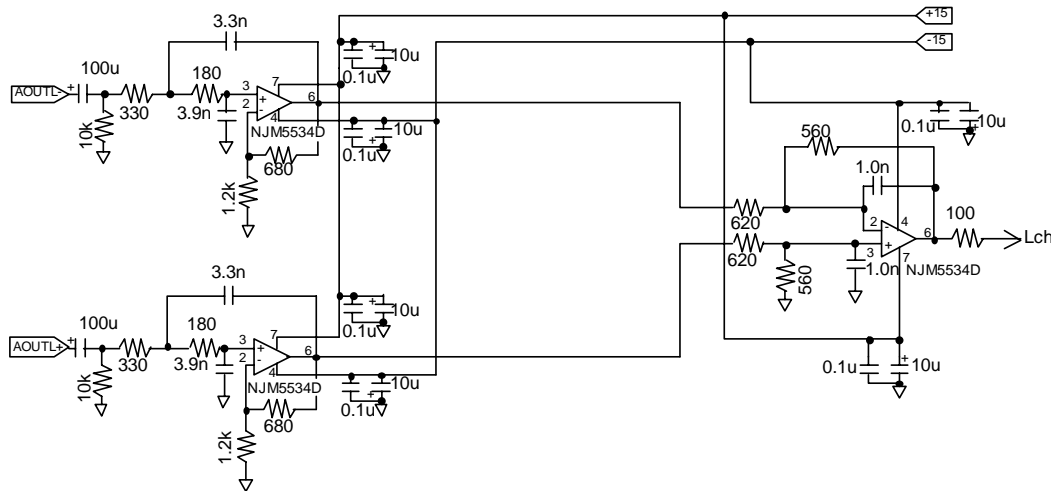

Figure 4 External Analog Filter

AKD4396-SBW Filter	40kHz (Double)	80kHz (quad)
Internal Filter	-0.3dB	-1dB
External LPF	-0.19dB	-0.85dB
Total	-0.49dB	-1.85dB

This table shows typical value.
Table 5 Frequency Responses

2. Control Software Manual

■ Set-up of evaluation board and control software

1. Set up the AKD4396-SBW according to previous term.
2. Connect IBM-AT compatible PC with AKD4396-SBW by 10-line type flat cable (packed with AKD4396-SBW). Take care of the direction of 10pin header. (Please install the driver in the CD-ROM when this control software is used on Windows 2000/XP. Please refer “Installation Manual of Control Software Driver by AKM device control software”. In case of Windows95/98/ME, this installation is not needed. This control software does not operate on Windows NT.)
3. Insert the CD-ROM labeled “AKD4396-SBW Evaluation Kit” into the CD-ROM drive.
4. Access the CD-ROM drive and double-click the icon of “akd4396.exe” to set up the control program.
5. Then please evaluate according to the follows.

■ Operation flow

Keep the following flow.

1. Set up the control program according to explanation above.
2. Click “Port Reset” button.

■ Explanation of each buttons

- | | |
|----------------------|---|
| 1. [Port Reset] : | Set up the USB interface board (AKDUSBIF-A) . |
| 2. [Write default] : | Initialize the register of AK4396. |
| 3. [All Write] : | Write all registers that is currently displayed. |
| 4. [Function1] : | Dialog to write data by keyboard operation. |
| 5. [Function2] : | Dialog to write data by keyboard operation. |
| 6. [Function3] : | The sequence of register setting can be set and executed. |
| 7. [Function4] : | The sequence that is created on [Function3] can be assigned to buttons and executed. |
| 8. [Function5]: | The register setting that is created by [SAVE] function on main window can be assigned to buttons and executed. |
| 9. [SAVE] : | Save the current register setting. |
| 10. [OPEN] : | Write the saved values to all register. |
| 11. [Write] : | Dialog to write data by mouse operation. |

■ Indication of data

Input data is indicated on the register map. Red letter indicates “H” or “1” and blue one indicates “L” or “0”. Blank is the part that is not defined in the datasheet.

■ Explanation of each dialog

1. [Write Dialog]: Dialog to write data by mouse operation

There are dialogs corresponding to each register.

Click the [Write] button corresponding to each register to set up the dialog. If you check the check box, data becomes "H" or "1". If not, "L" or "0".

If you want to write the input data to AK4396, click [OK] button. If not, click [Cancel] button.

2. [Function1 Dialog] : Dialog to write data by keyboard operation

Address Box:	Input registers address in 2 figures of hexadecimal.
Data Box:	Input registers data in 2 figures of hexadecimal.

If you want to write the input data to AK4396, click [OK] button. If not, click [Cancel] button.

3. [Function2 Dialog] : Dialog to evaluate ATT

Address Box:	Input registers address in 2 figures of hexadecimal.
Start Data Box:	Input starts data in 2 figures of hexadecimal.
End Data Box:	Input end data in 2 figures of hexadecimal.
Interval Box:	Data is written to AK4642 by this interval.
Step Box:	Data changes by this step.
Mode Select Box:	

If you check this check box, data reaches end data, and returns to start data.

[Example]	Start Data = 00, End Data = 09
Data flow:	00 01 02 03 04 05 06 07 08 09 09 08 07 06 05 04 03 02 01 00

If you do not check this check box, data reaches end data, but does not return to start data.

[Example]	Start Data = 00, End Data = 09
Data flow:	00 01 02 03 04 05 06 07 08 09

If you want to write the input data to AK4396, click [OK] button. If not, click [Cancel] button.

4. [Save] and [Open]

4-1. [Save]

Save the current register setting data. The extension of file name is "akr".

(Operation flow)

- (1) Click [Save] Button.
- (2) Set the file name and push [Save] Button. The extension of file name is "akr".

4-2. [Open]

The register setting data saved by [Save] is written to AK4396. The file type is the same as [Save].

(Operation flow)

- (1) Click [Open] Button.
- (2) Select the file (*.akr) and Click [Open] Button.

5. [Function3 Dialog]

The sequence of register setting can be set and executed.

(1) Click [F3] Button.

(2) Set the control sequence.

Set the address, Data and Interval time. Set “-1” to the address of the step where the sequence should be paused.

(3) Click [Start] button. Then this sequence is executed.

The sequence is paused at the step of Interval="-1". Click [START] button, the sequence restarts from the paused step.

This sequence can be saved and opened by [Save] and [Open] button on the Function3 window. The extension of file name is “aks”.

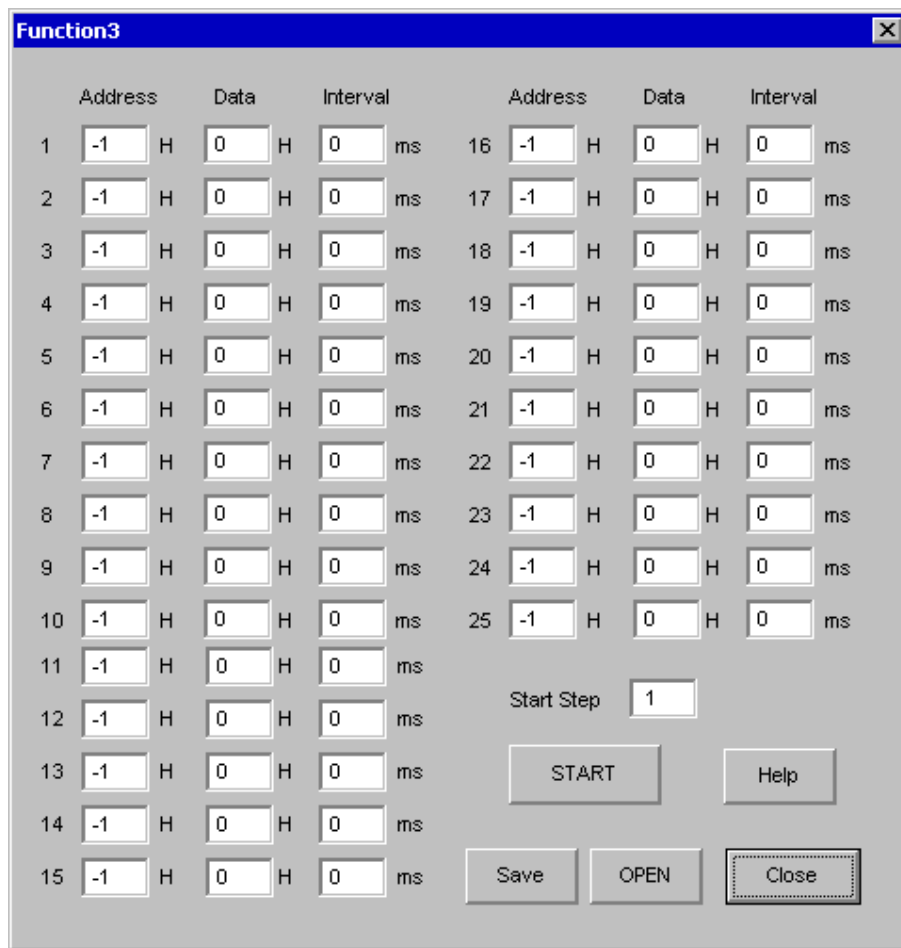

Figure 5. Window of [F3]

6. [Function4 Dialog]

The sequence that is created on [Function3] can be assigned to buttons and executed. When [F4] button is clicked, the window as shown in Figure 6 opens.

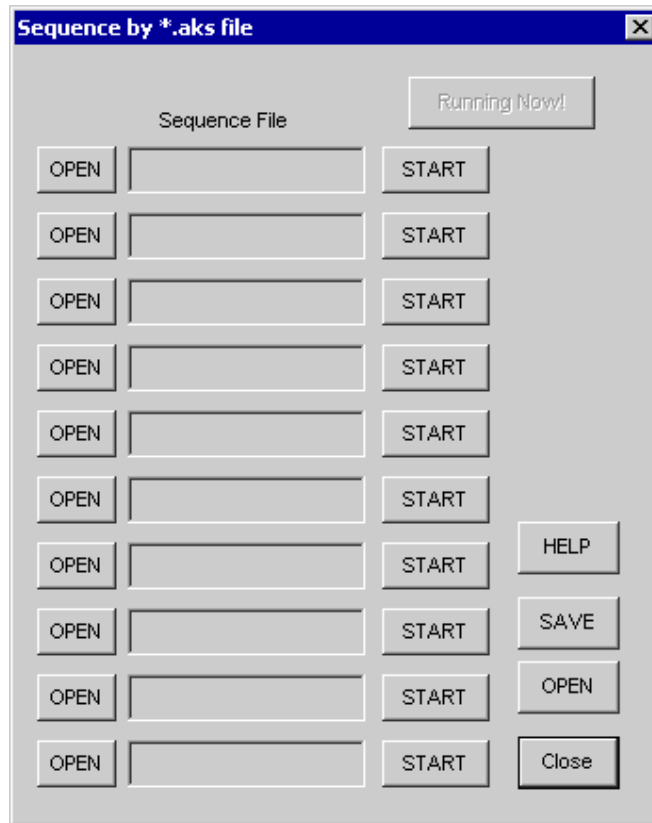

Figure 6. [F4] window

6-1. [OPEN] buttons on left side and [START] buttons

(1) Click [OPEN] button and select the sequence file (*.aks).

The sequence file name is displayed as shown in Figure 7.

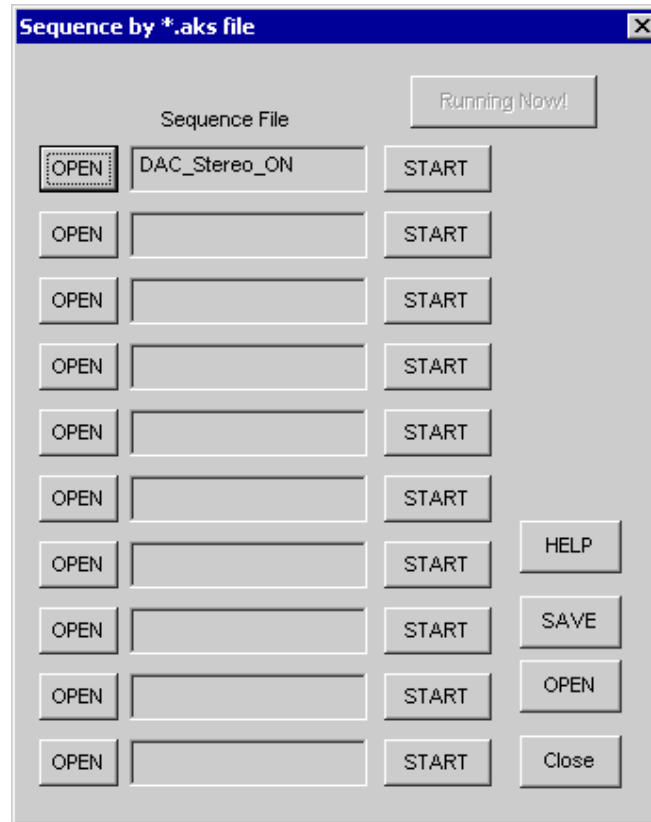

Figure 7. [F4] window(2)

(2) Click [START] button, then the sequence is executed.

3-2. [SAVE] and [OPEN] buttons on right side

[SAVE] : The sequence file names can assign be saved. The file name is *.ak4.

[OPEN] : The sequence file names assign that are saved in *.ak4 are loaded.

3-3. Note

(1) This function doesn't support the pause function of sequence function.

(2) All files need to be in same folder used by [SAVE] and [OPEN] function on right side.

(3) When the sequence is changed in [Function3], the file should be loaded again in order to reflect the change.

7. [Function5 Dialog]

The register setting that is created by [SAVE] function on main window can be assigned to buttons and executed. When [F5] button is clicked, the following window as shown in Figure 8 opens.

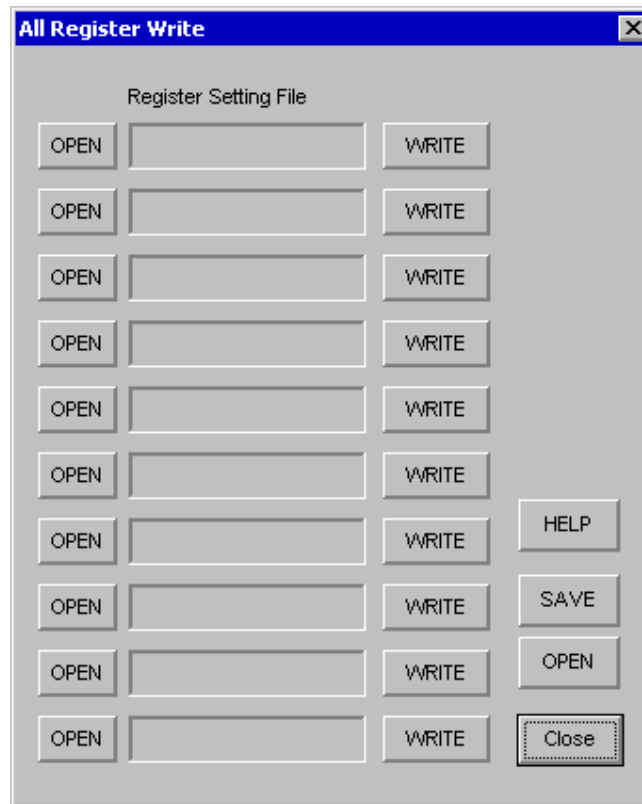

Figure 8. [F5] window

7-1. [OPEN] buttons on left side and [WRITE] button

- (1) Click [OPEN] button and select the register setting file (*.akr).
- (2) Click [WRITE] button, then the register setting is executed.

7-2. [SAVE] and [OPEN] buttons on right side

[SAVE] : The register setting file names assign can be saved. The file name is *.ak5.

[OPEN] : The register setting file names assign that are saved in *.ak5 are loaded.

7-3. Note

- (1) All files need to be in same folder used by [SAVE] and [OPEN] function on right side.
- (2) When the register setting is changed by [Save] Button in main window, the file should be loaded again in order to reflect the change.

Measurement Results

[Measurement condition]

- Measurement unit : Audio Precision System two Cascade (AP2)
- MCLK : 512fs (44.1kHz), 256fs (96kHz), 128fs (192kHz)
- BICK : 64fs
- fs : 44.1kHz, 96kHz, 192kHz
- Bit : 24bit
- Power Supply : AVDD= DVDD=5V
- Interface : Internal DIR (48kHz, 96kHz, 192kHz)
- Temperature : Room

fs=44.1kHz

Parameter	Input signal	Measurement filter	Results
S/(N+D)	1kHz, 0dB	20kLPF	99.4 dB
DR	1kHz, -60dB	22kLPF, A-weighted	119.0 dB
S/N	"0" data	22kLPF, A-weighted	119.0 dB

fs=96kHz

Parameter	Input signal	Measurement filter	Results
S/(N+D)	1kHz, 0dB	40kLPF	99.0 dB
DR	1kHz, -60dB	40kLPF	114.0 dB
DR	1kHz, -60dB	22kLPF, A-weighted	119.3 dB
S/N	"0" data	40kLPF	114.0 dB
S/N	"0" data	22kLPF, A-weighted	119.3 dB

fs=192kHz

Parameter	Input signal	Measurement filter	Results
S/(N+D)	1kHz, 0dB	40kLPF	98.7 dB
DR	1kHz, -60dB	40kLPF	111.2 dB
DR	1kHz, -60dB	22kLPF, A-weighted	116.4 dB
S/N	"0" data	40kLPF	113.6 dB
S/N	"0" data	22kLPF, A-weighted	119.0 dB

Plots

(fs=44.1kHz)

AKM

AK4396 FFT fs=44.1kHz
AVDD=DVDD=5V, 0dBFS input

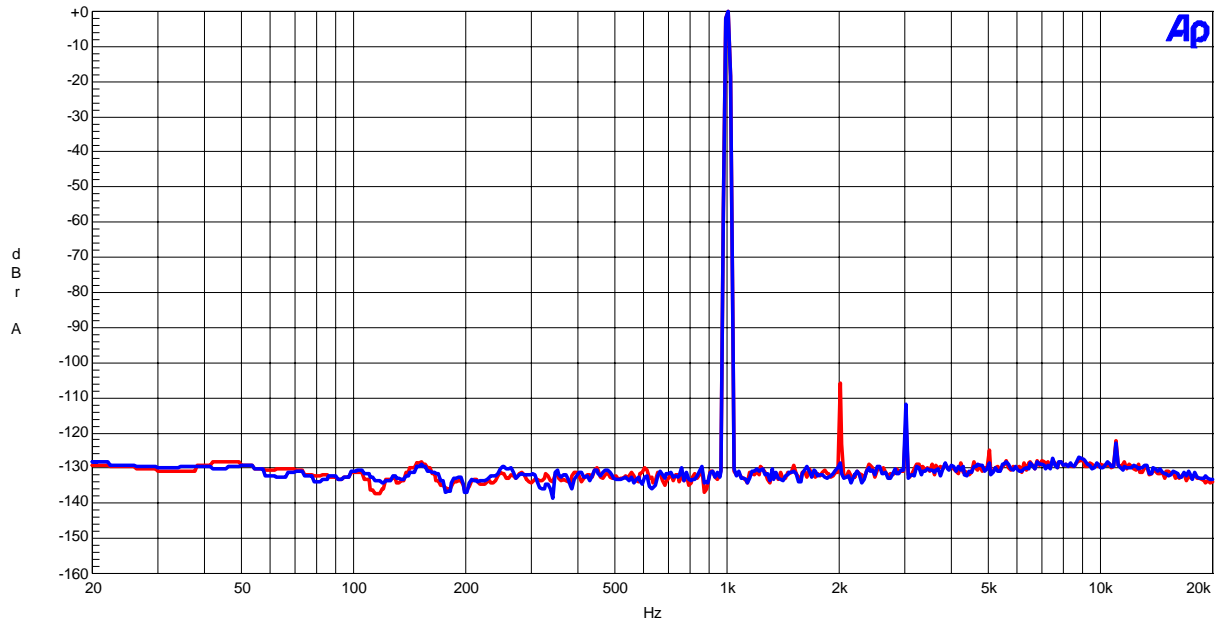

Figure 9 FFT (fin=1kHz, Input Level=0dBFS)

AKM

AK4396 FFT plot fs=44.1kHz
AVDD=DVDD=5V, -60dBFS input

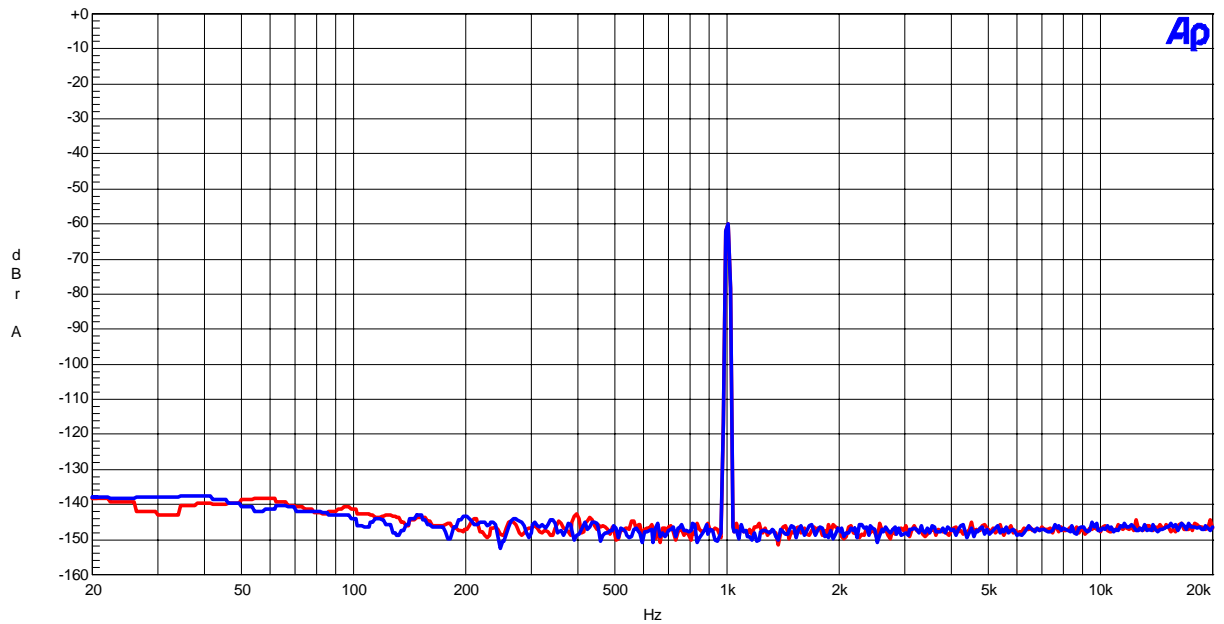

Figure 10 FFT (fin=1kHz, Input Level=-60dBFS)

(fs=44.1kHz)

AKM

AK4396 FFT plot fs=44.1kHz
AVDD=DVDD=5V, No signal input

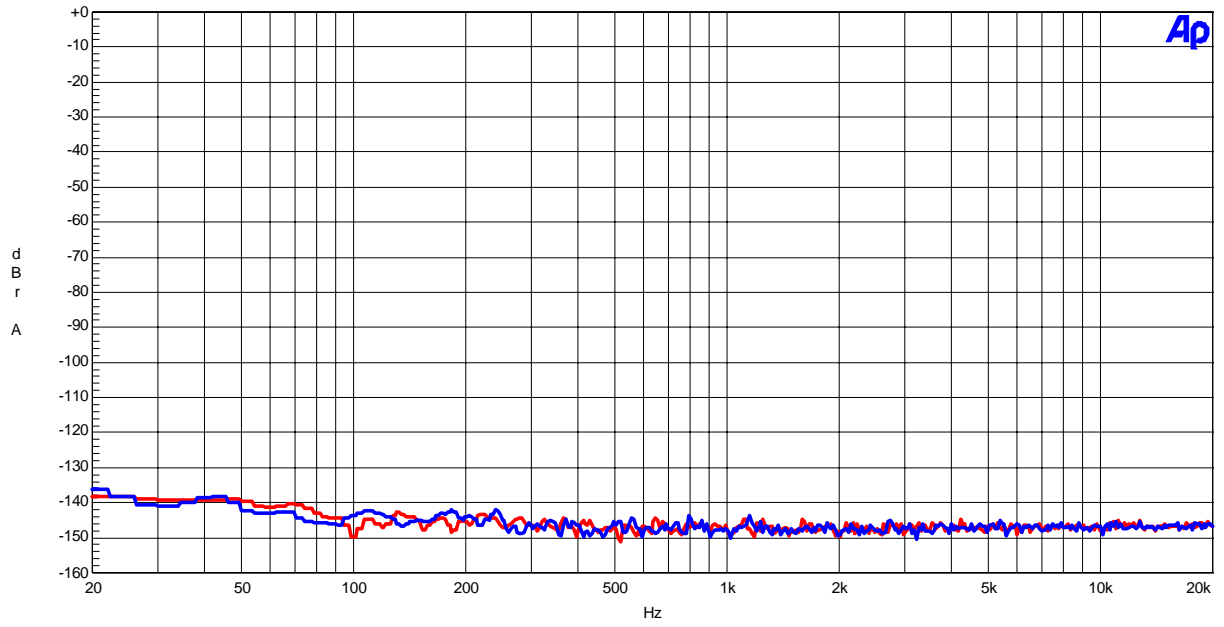

Figure 11 FFT (Noise Floor)

AKM

AK4396 FFT fs=44.1kHz
AVDD=DVDD=5V, 0dBFS input, outband noise

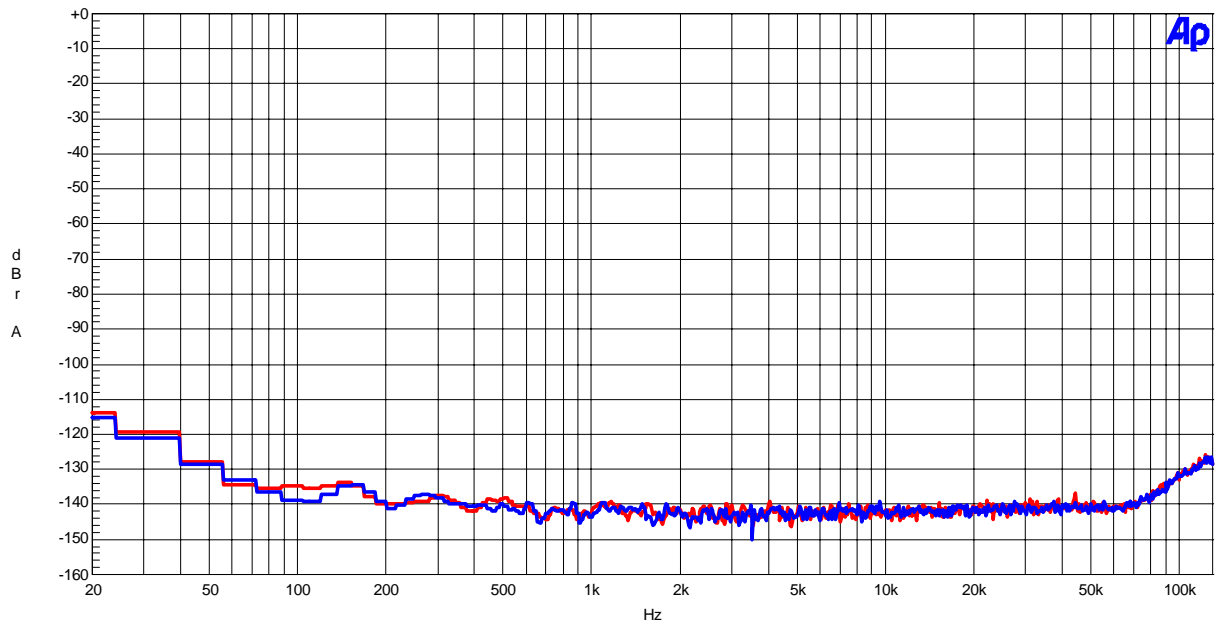

Figure 12 FFT (Out of band noise)

(fs=44.1kHz)

AKM

AK4396 THD+N vs Input Level fs=44.1kHz
AVDD=DVDD=5V, 0dBFS

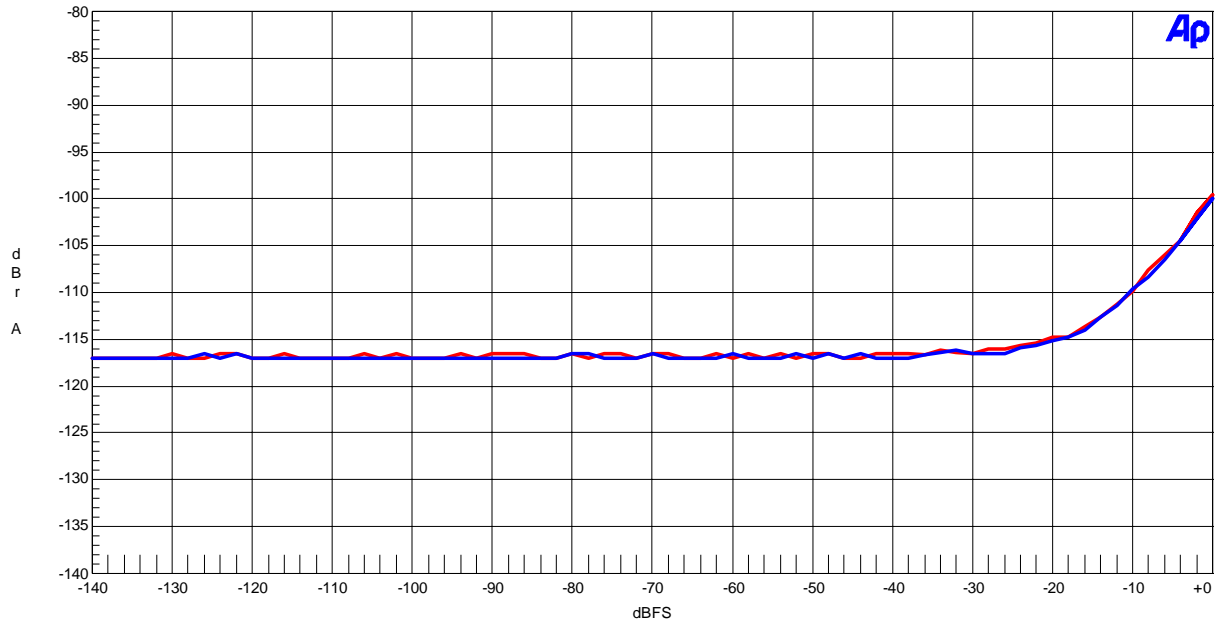

Figure 13 THD+N vs. Input level (fin=1kHz)

AKM

AK4396 THD+N vs Input Frequency fs=44.1kHz
AVDD=DVDD=5V, 0dBFS input

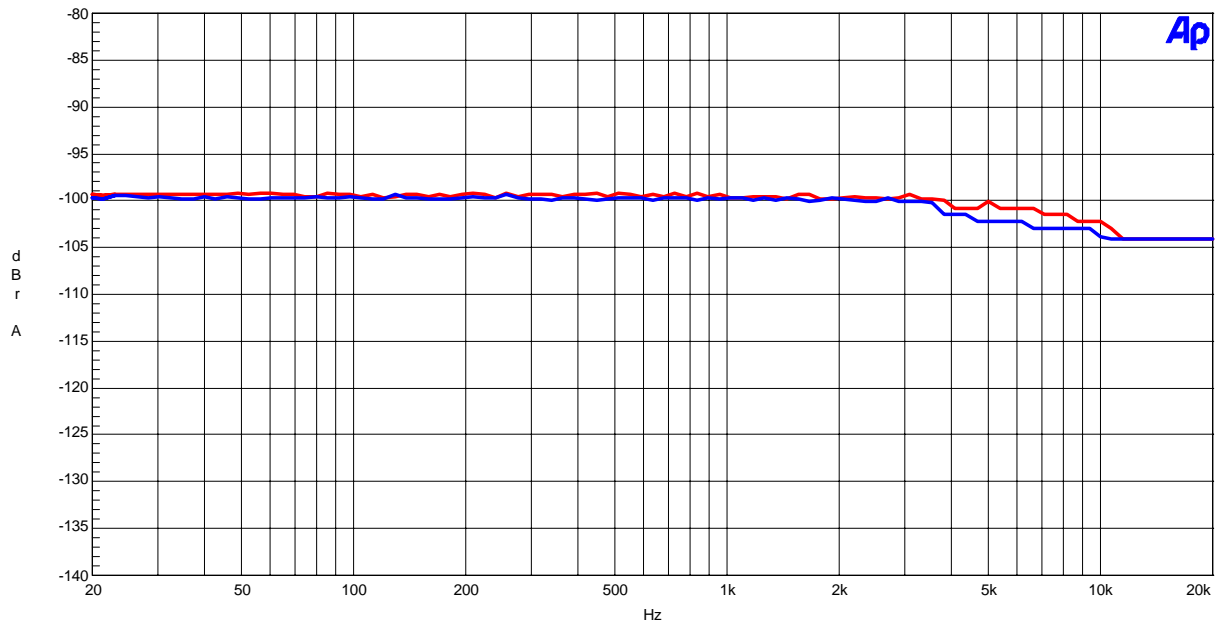

Figure 14 THD+N vs. Input Frequency (Input level=0dBFS)

(fs=44.1kHz)

AKM

AK4396 Linearity fs=44.1kHz
AVDD=DVDD=5V, 0dBFS input

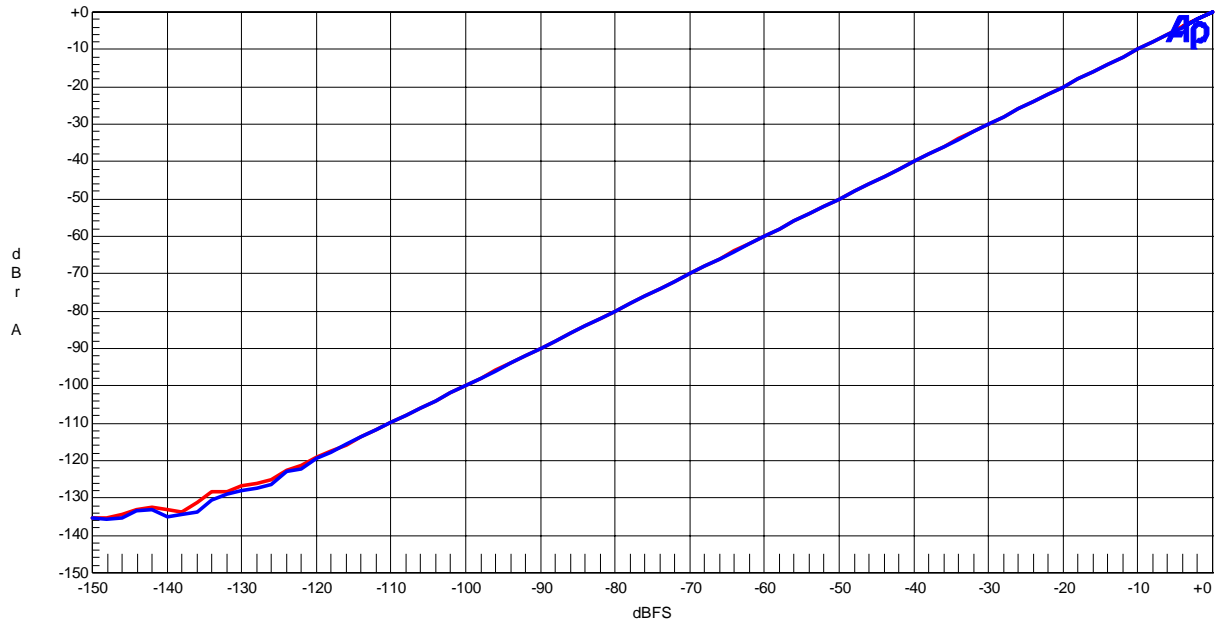

Figure 15 Linearity (fin=1kHz)

AKM

AK4396 Frequency Respons fs=44.1kHz
AVDD=DVDD=5V, 0dBFS input

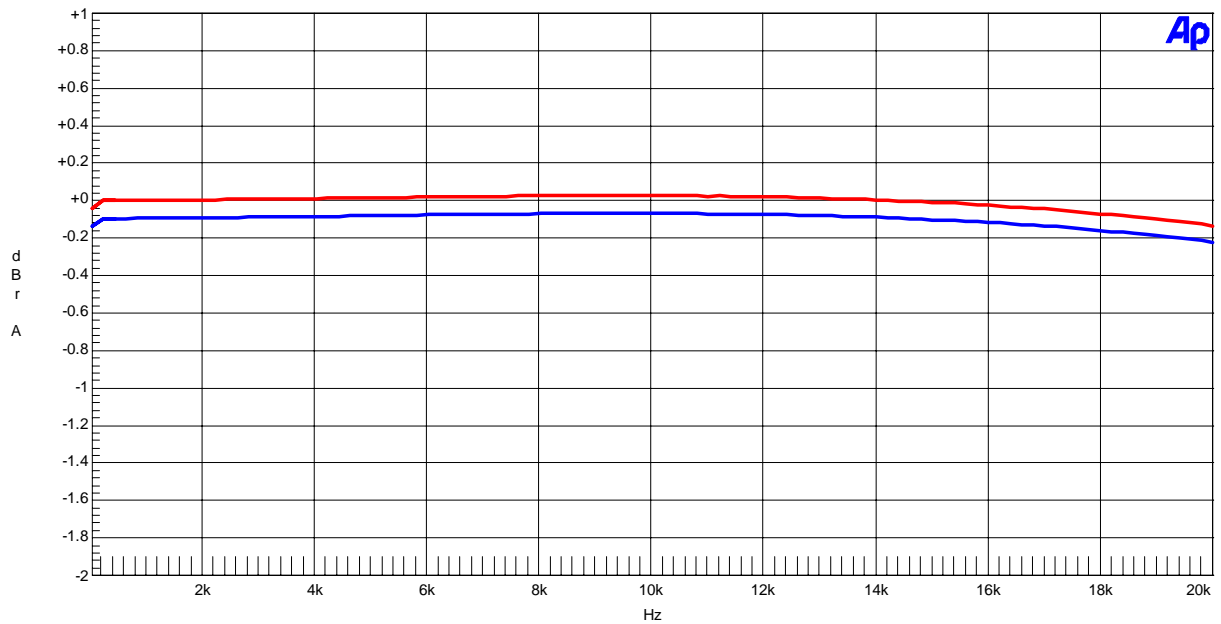

Figure 16 Frequency Response (Input level=0dBFS)

(fs=44.1kHz)

AKM

AK4396 Crosstalk (Red:Lch, Blue:Rch) fs=44.1kHz
AVDD=DVDD=5V, 0dBFS input

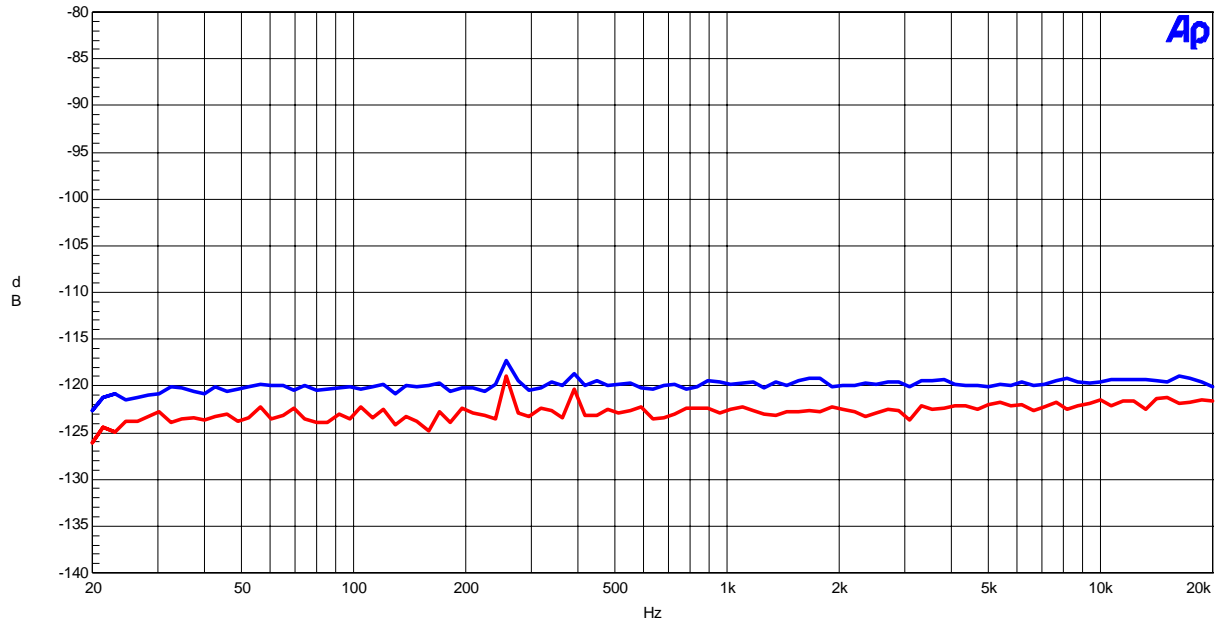

Figure 17 Crosstalk (Input level=0dBFS)

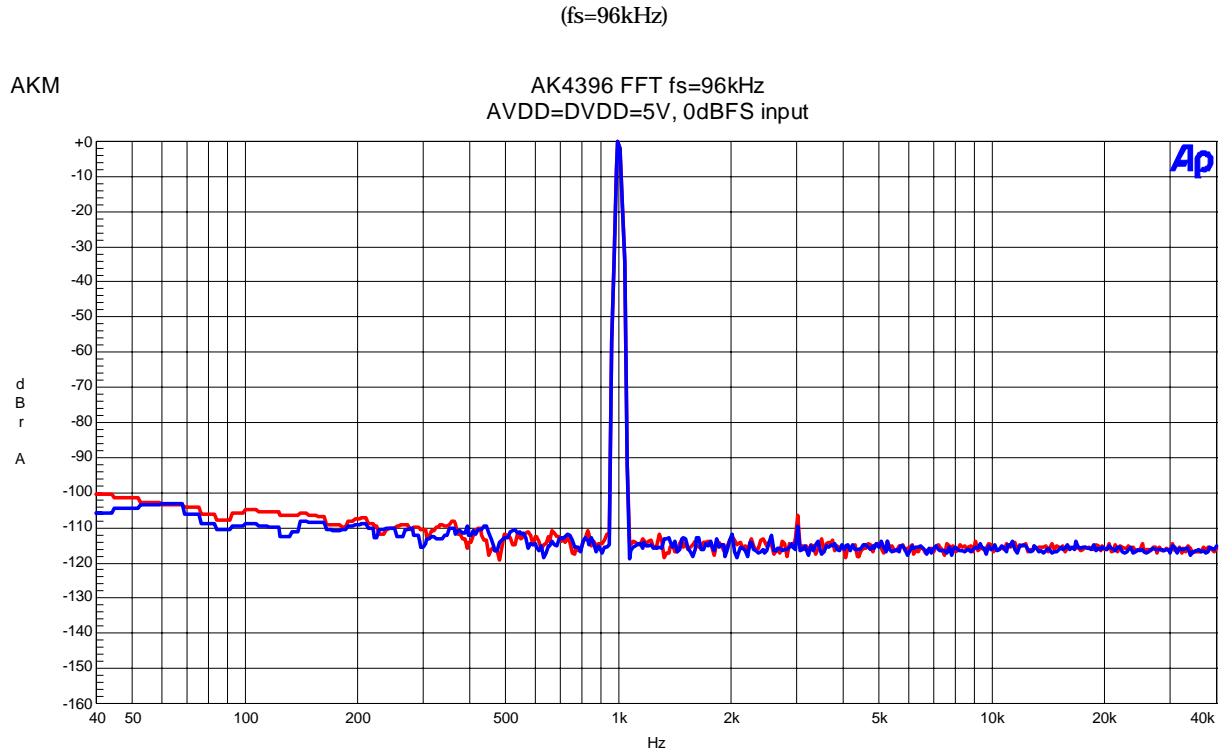

Figure 18 FFT (fin=1kHz, Input Level=0dBFS)

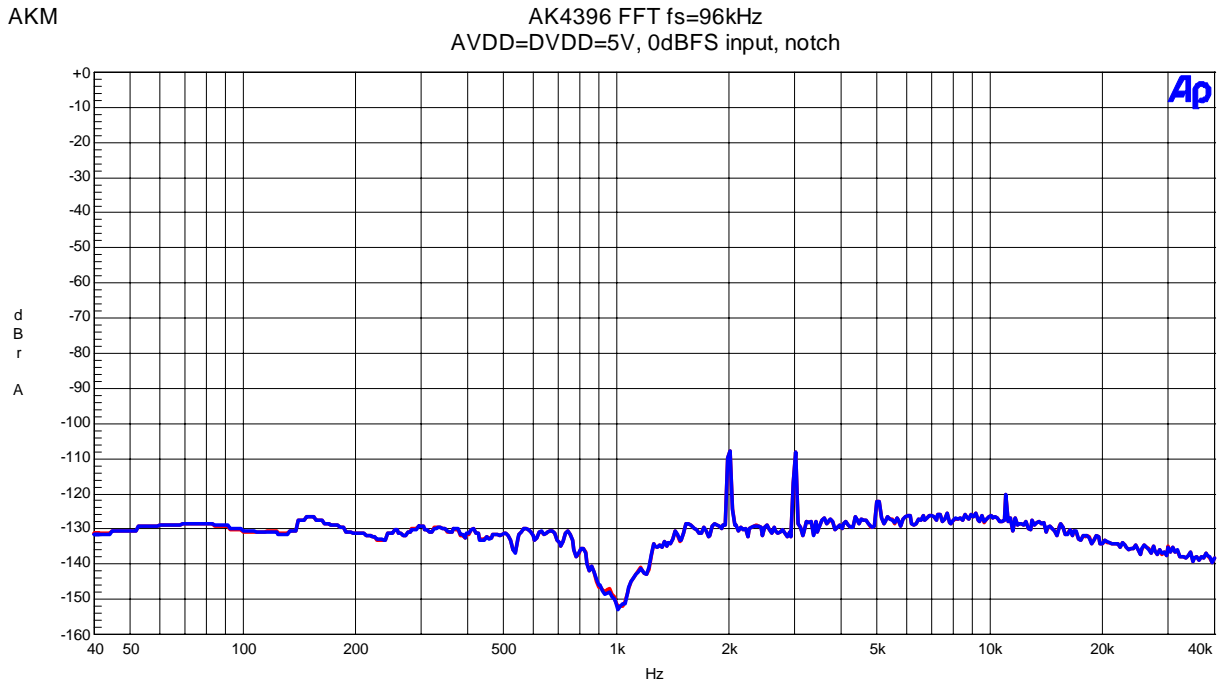

Figure 19 FFT(fin=1kHz, Input Level=0dBFS, Notch)

(fs=96kHz)

AKM

AK4396 FFT fs=96kHz
AVDD=DVDD=5V, -60dBFS input

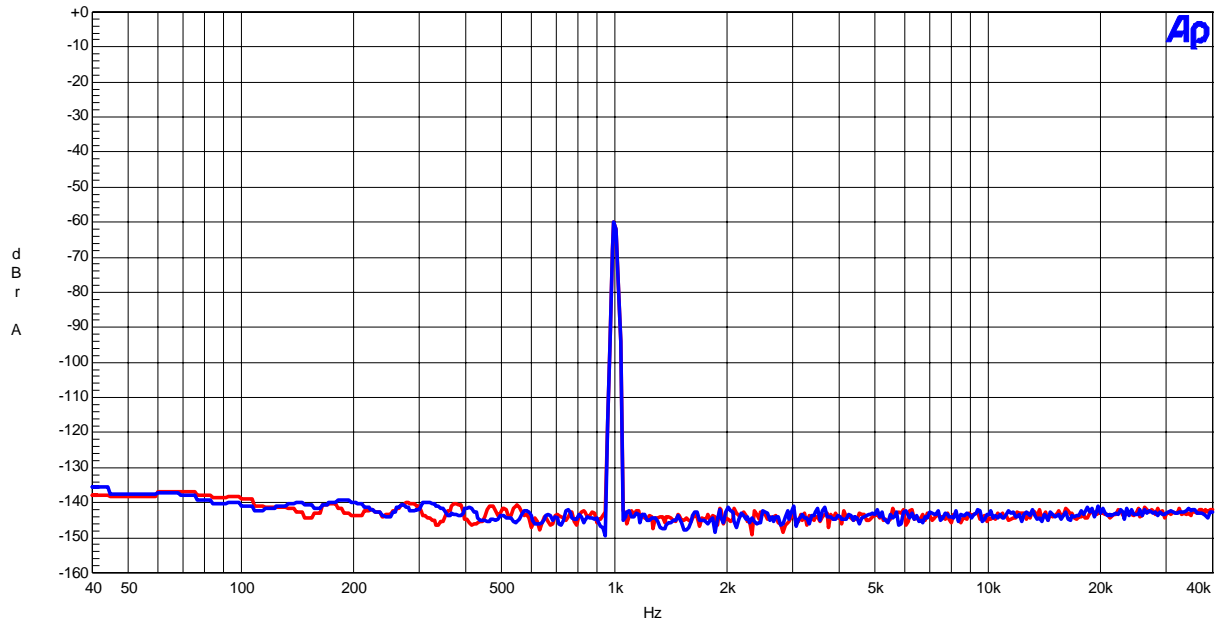

Figure 20 FFT (fin=1kHz, Input Level=-60dBFS)

AKM

AK4396 FFT fs=96kHz
AVDD=DVDD=5V, No signal input

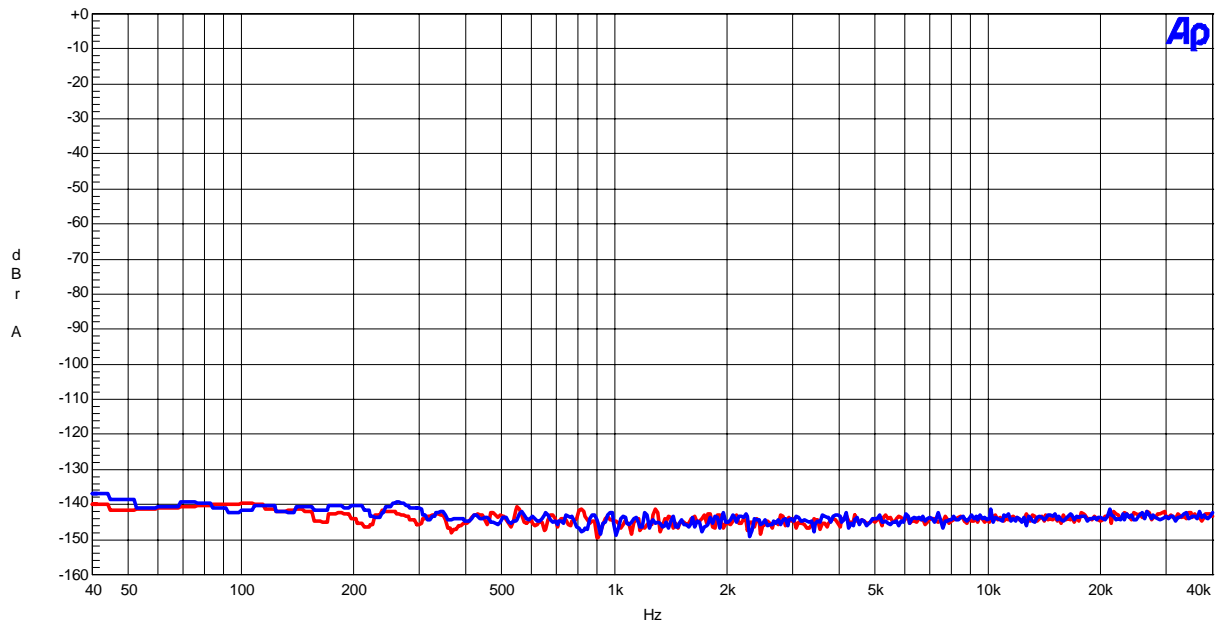

Figure 21 FFT (Noise Floor)

(fs=96kHz)

AKM

AK4396 THD+N vs Input Level fs=96kHz
AVDD=DVDD=5V, 0dBFS input

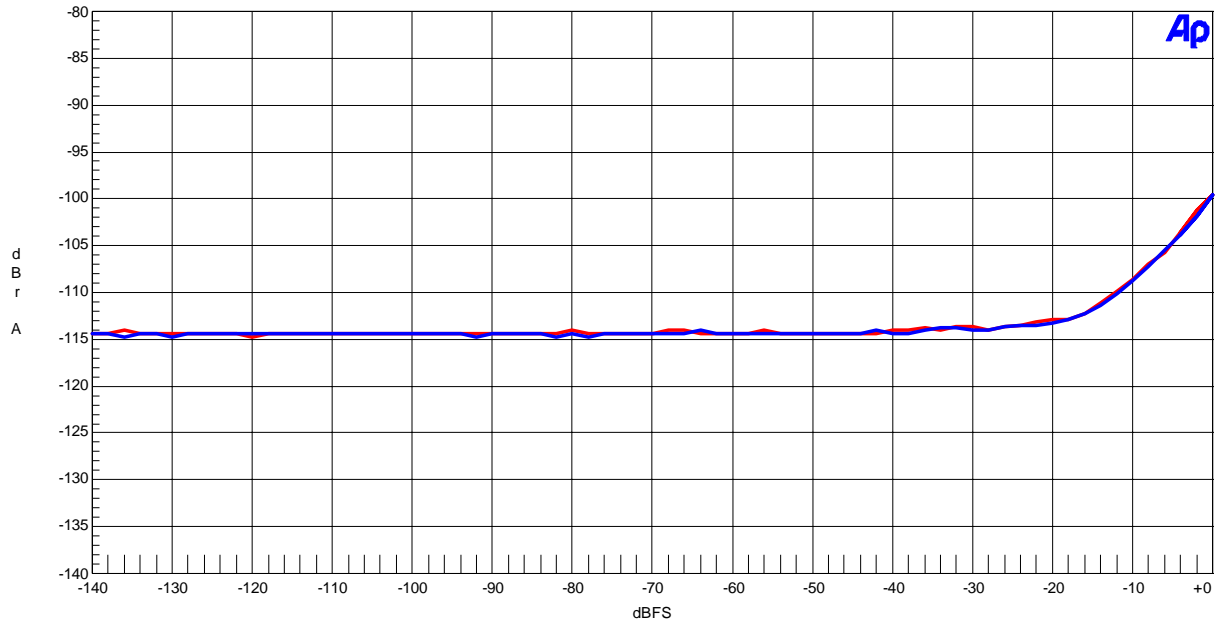

Figure 22 THD+N vs. Input level (fin=1kHz)

AKM

AK4396 THD+N vs Input Frequency fs=96kHz
AVDD=DVDD=5V, 0dBFS input

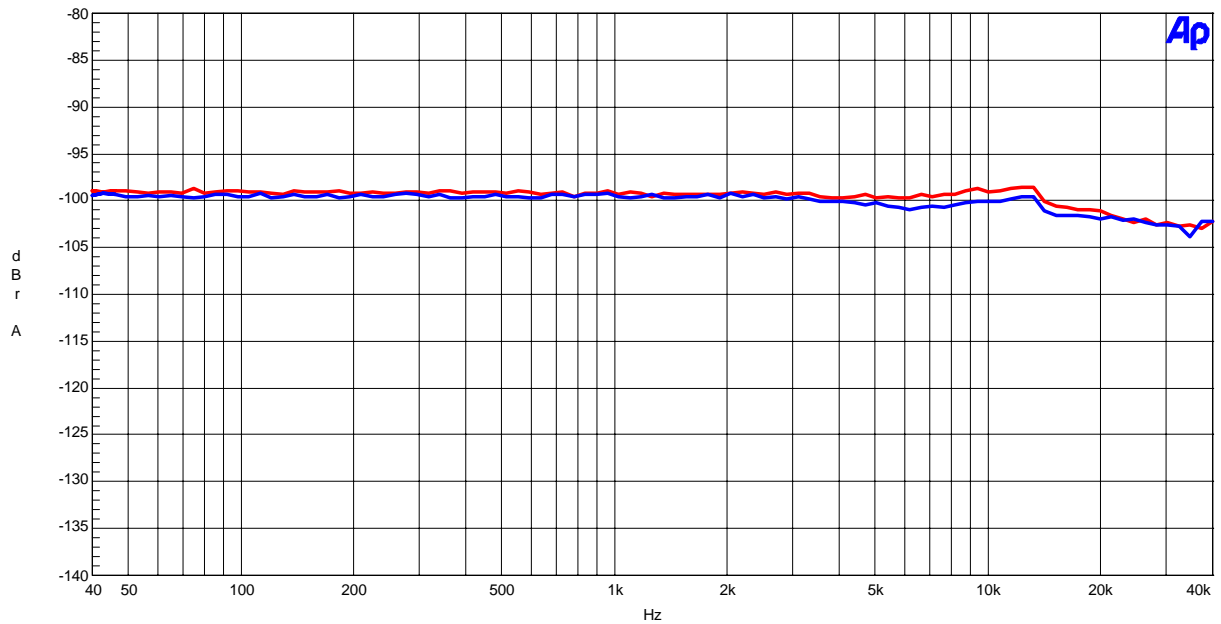

Figure 23 THD+N vs. Input Frequency (Input level=0dBFS)

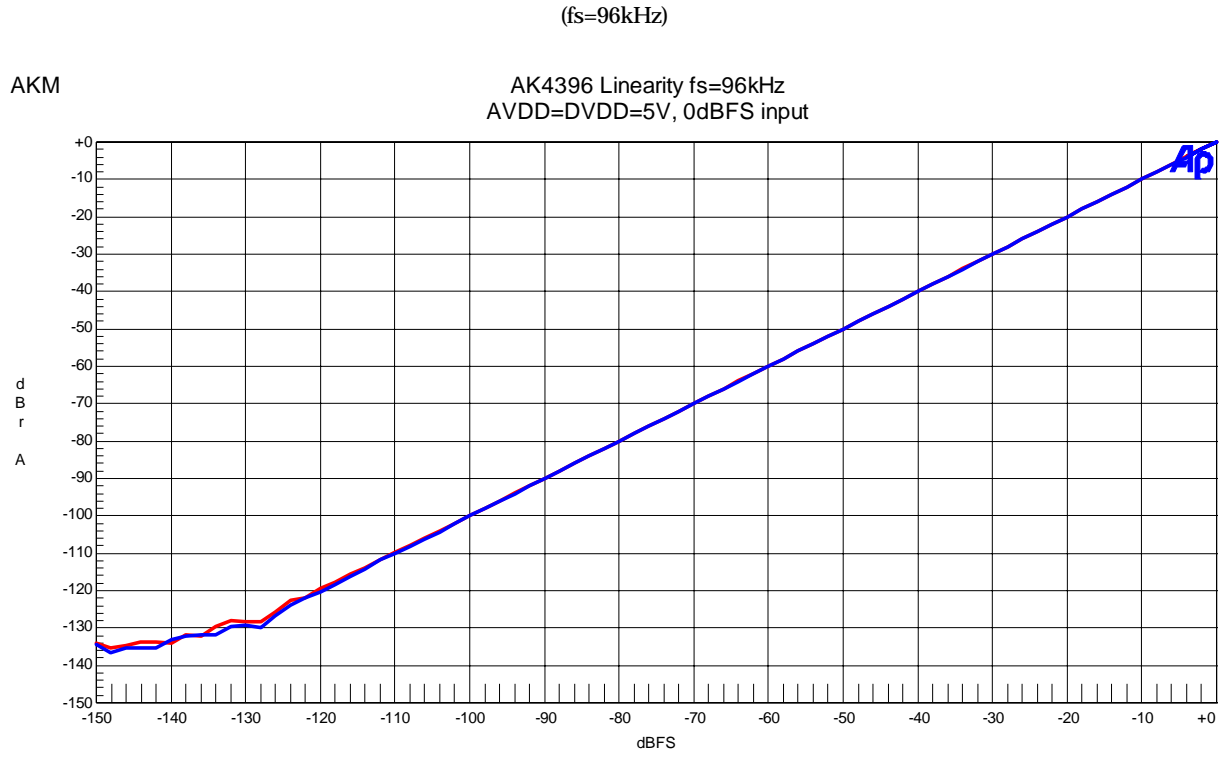

Figure 24 Linearity (fin=1kHz)

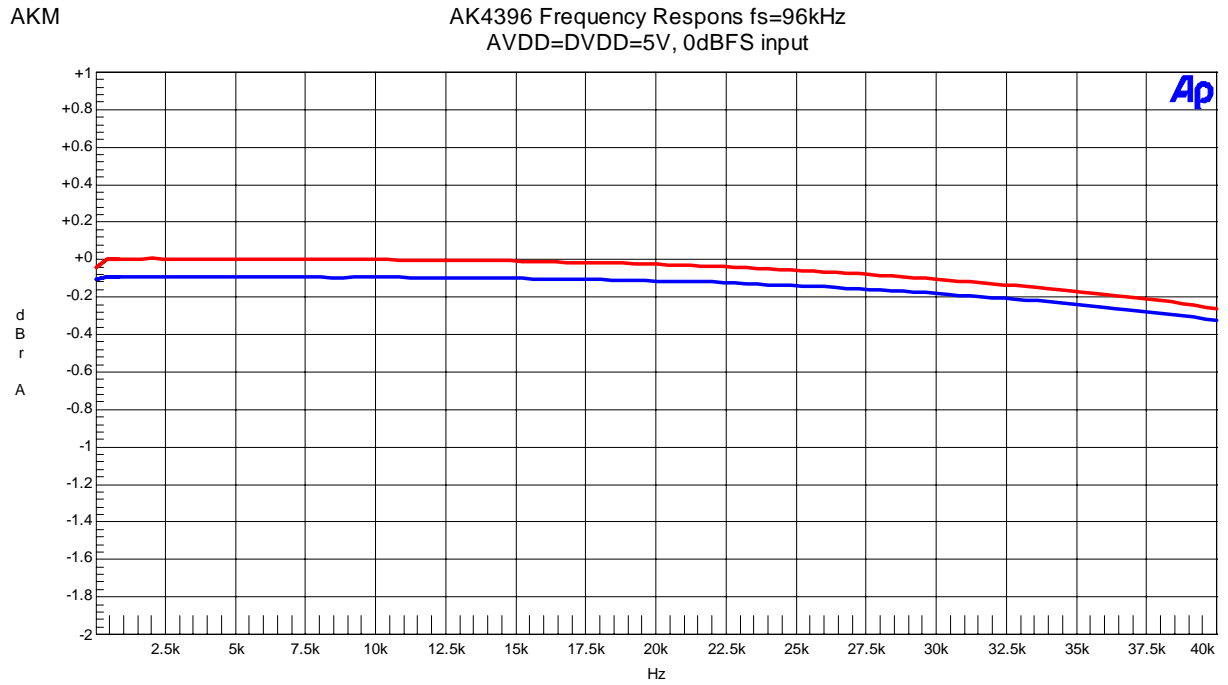

Figure 25 Frequency Response (Input level=0dBFS)

(fs=96kHz)

AKM

AK4396 Crosstalk (Red:Lch, Blue:Rch) fs=96kHz
AVDD=DVDD=5V, 0dBFS input

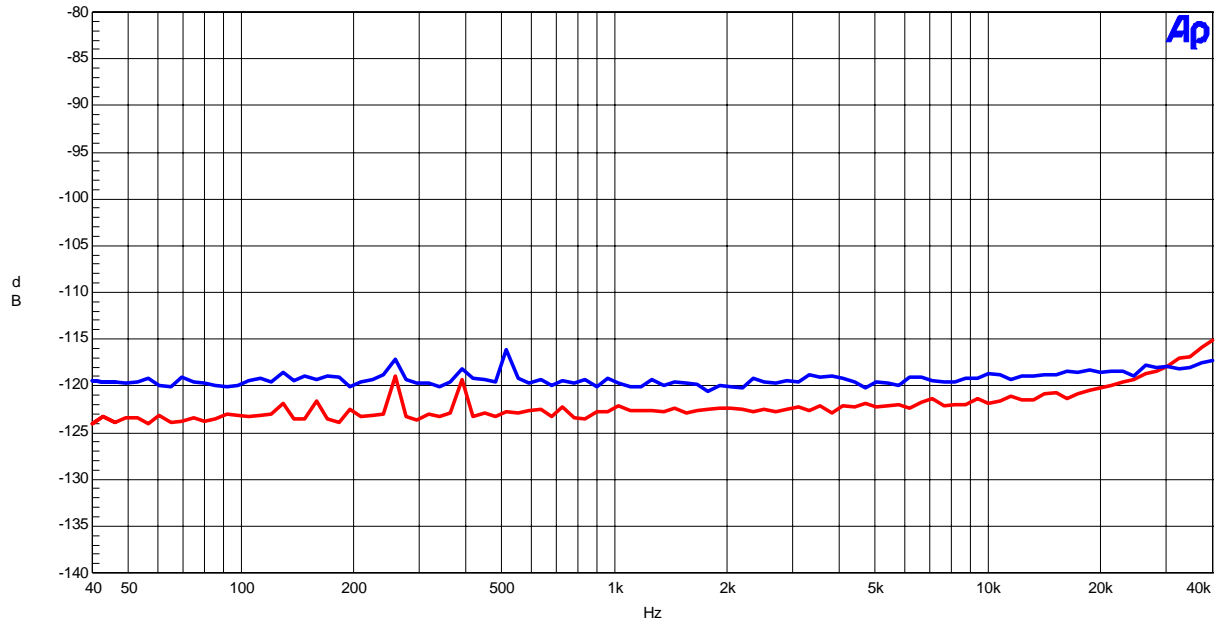

Figure 26 Crosstalk (Input level=0dBFS)

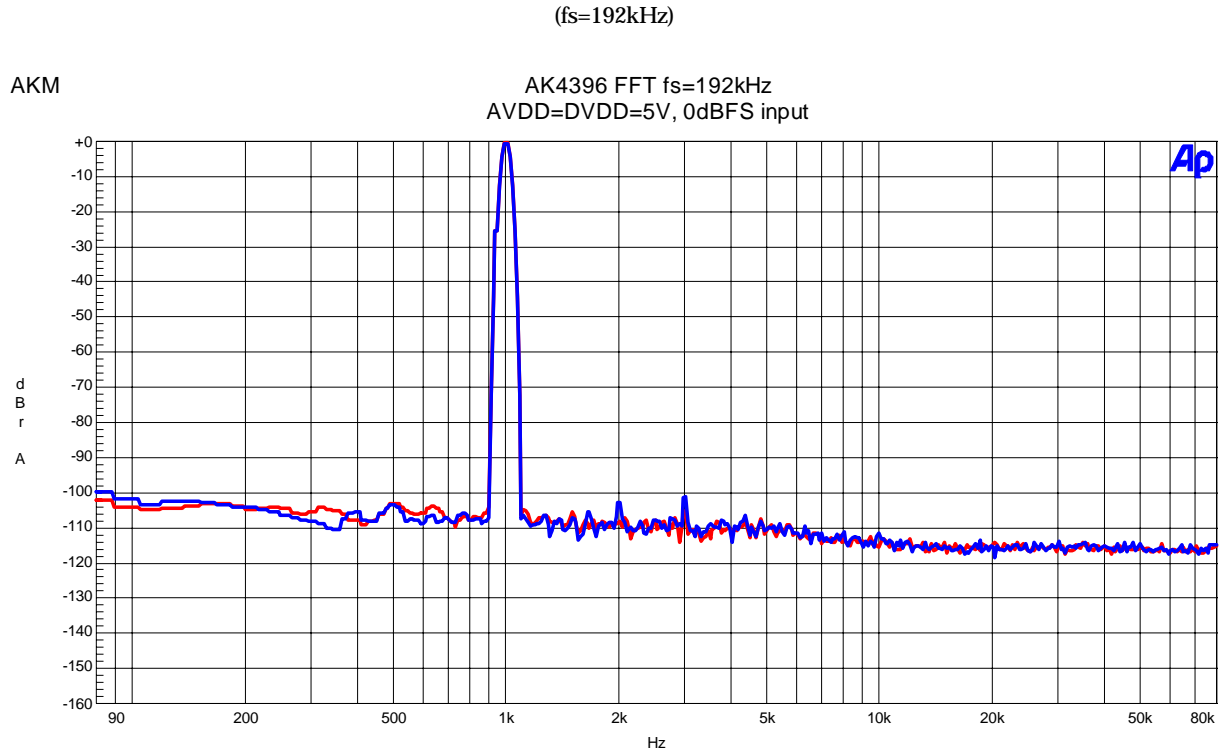

Figure 27 FFT (fin=1kHz, Input Level=0dBFS)

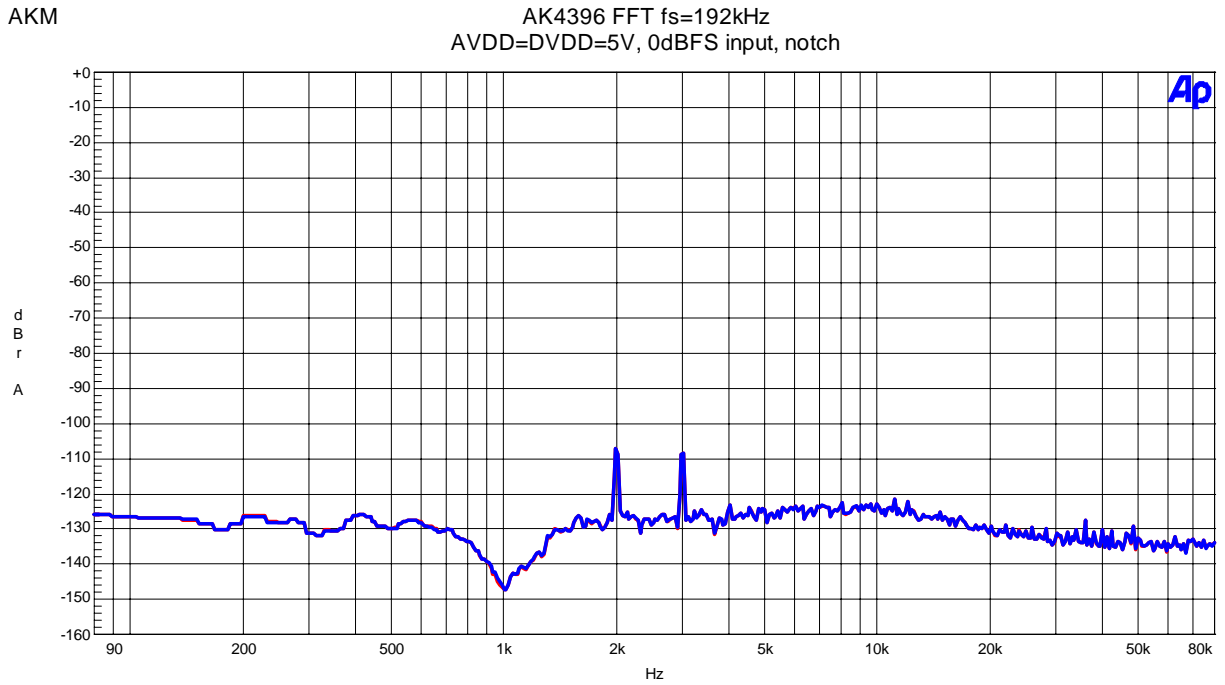

Figure 28 FFT(fin=1kHz, Input Level=0dBFS, Notch)

(fs=192kHz)

AKM

AK4396 FFT fs=192kHz
AVDD=DVDD=5V, -60dBFS input

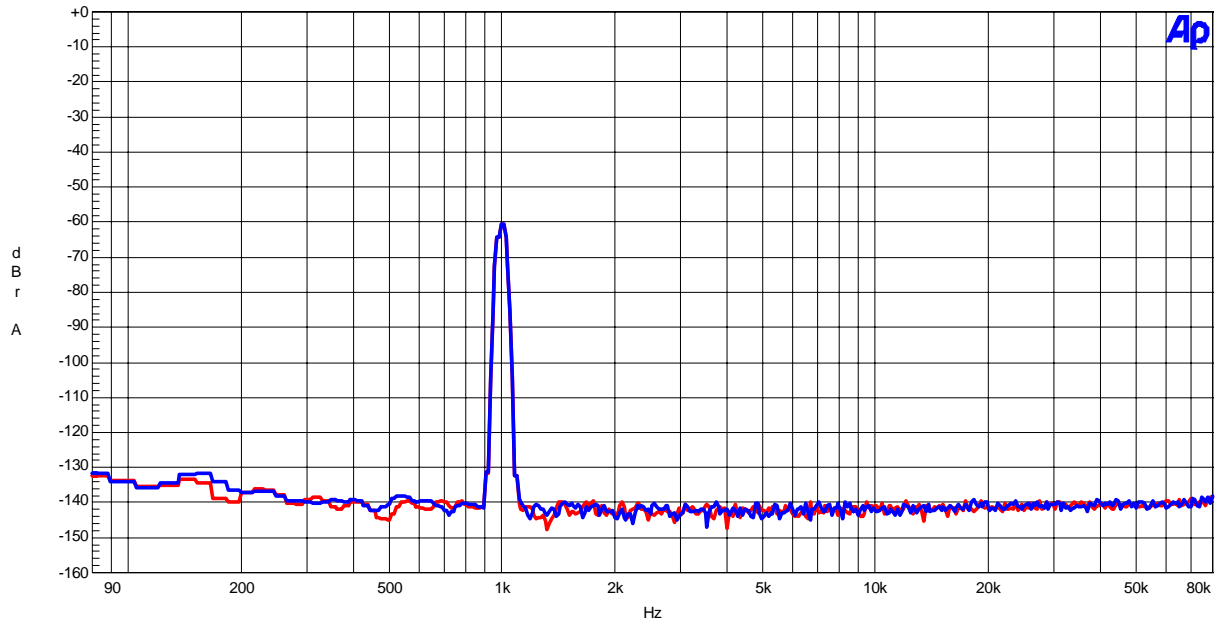

Figure 29 FFT (fin=1kHz, Input Level=-60dBFS)

AKM

AK4396 FFT fs=192kHz
AVDD=DVDD=5V, No signal input

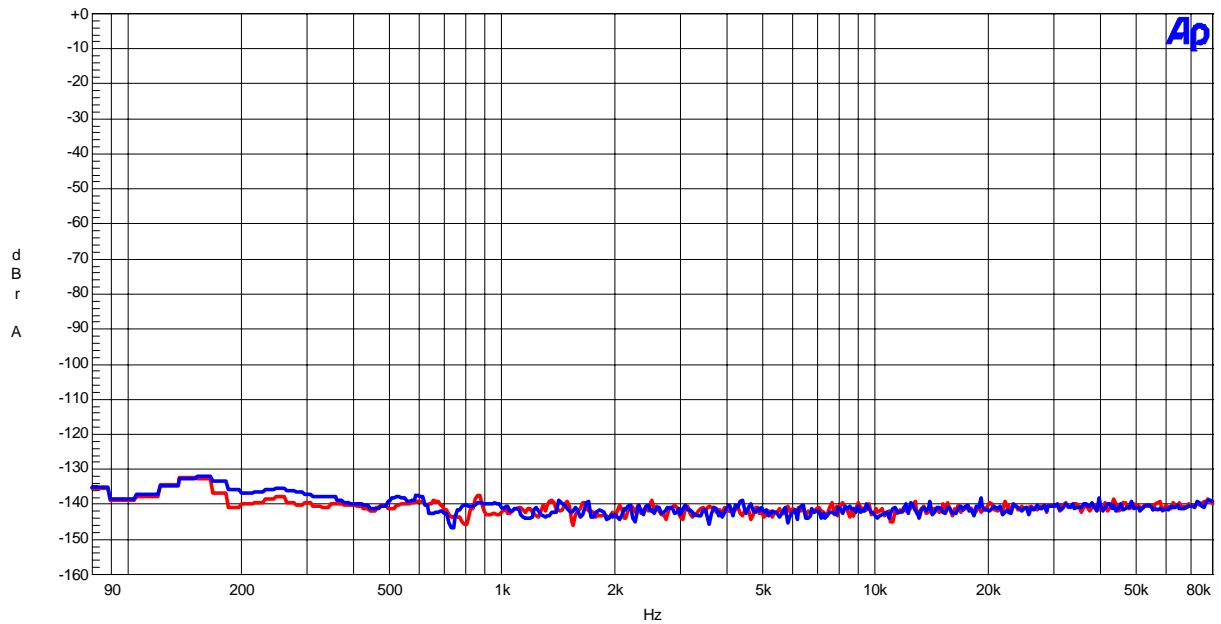

Figure 30 FFT (Noise Floor)

(fs=192kHz)

AKM

AK4396 THD+N vs Input Level fs=192kHz
AVDD=DVDD=5V, 0dBFS input

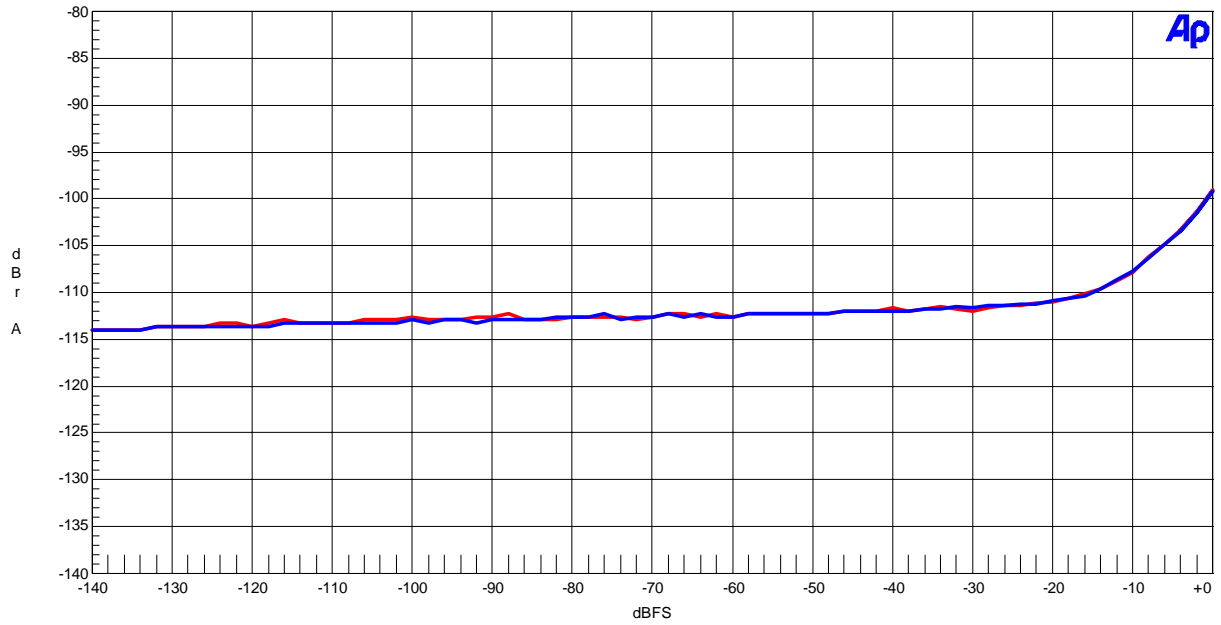

Figure 31 THD+N vs. Input level (fin=1kHz)

AKM

AK4396 THD+N vs Input Frequency fs=192kHz
AVDD=DVDD=5V, 0dBFS input

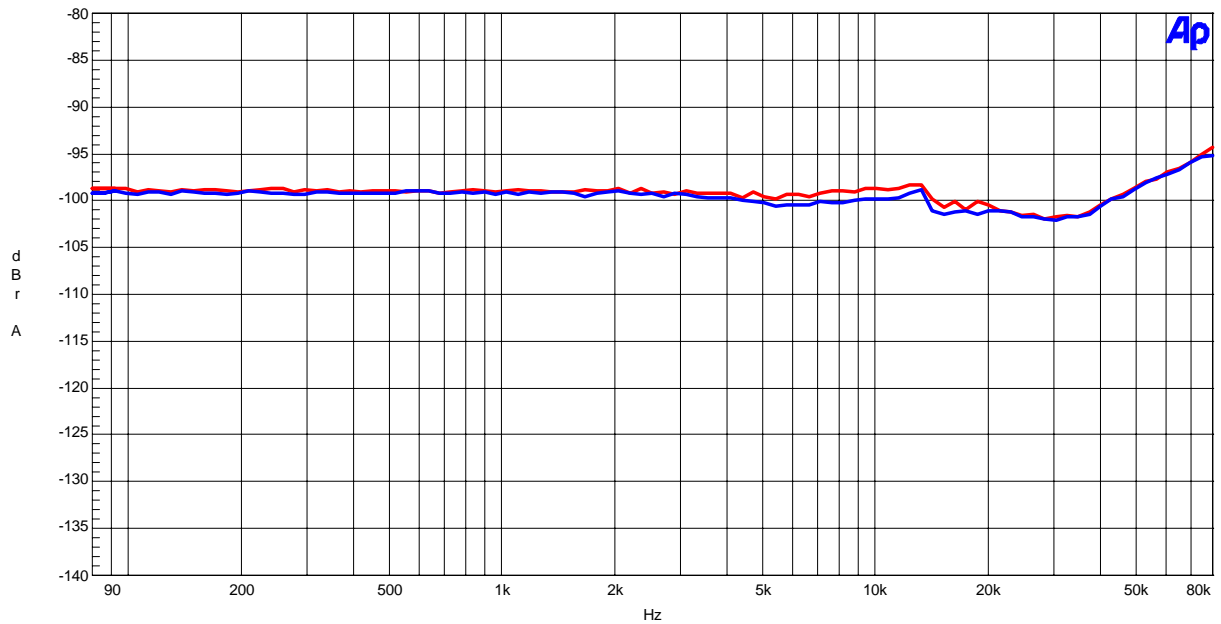

Figure 32 THD+N vs. Input Frequency (Input level=0dBFS)

(fs=192kHz)

AKM

AK4396 Linearity fs=192kHz
AVDD=DVDD=5V, 0dBFS input

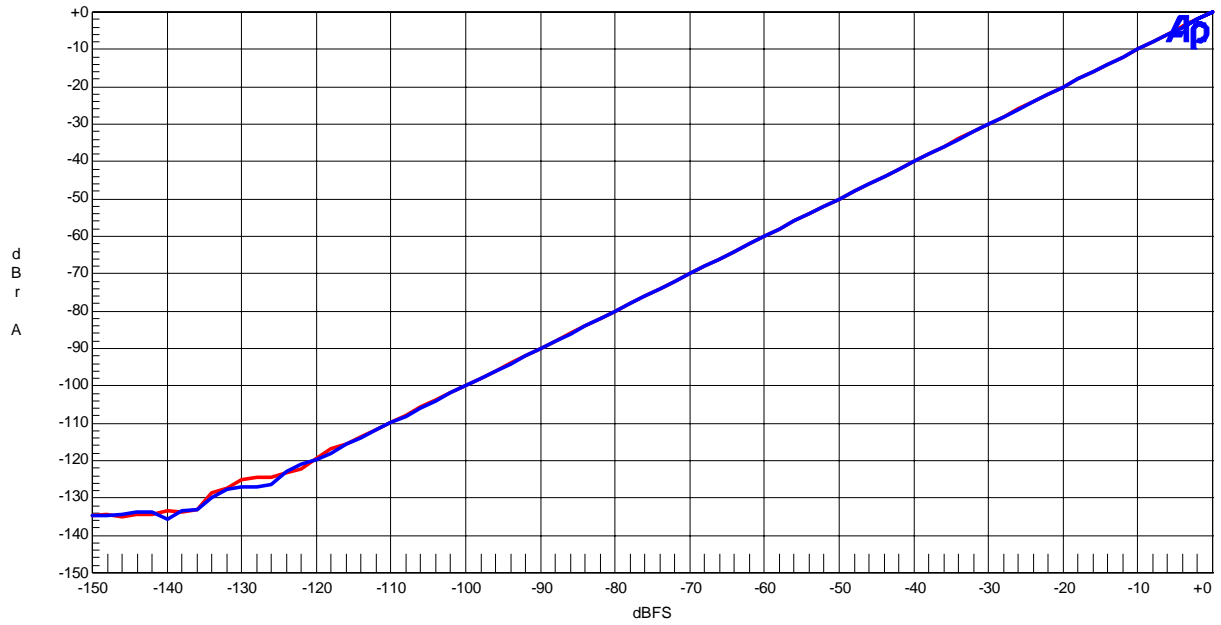

Figure 33 Linearity (fin=1kHz)

AKM

AK4396 Frequency Respons fs=192kHz
AVDD=DVDD=5V, 0dBFS input

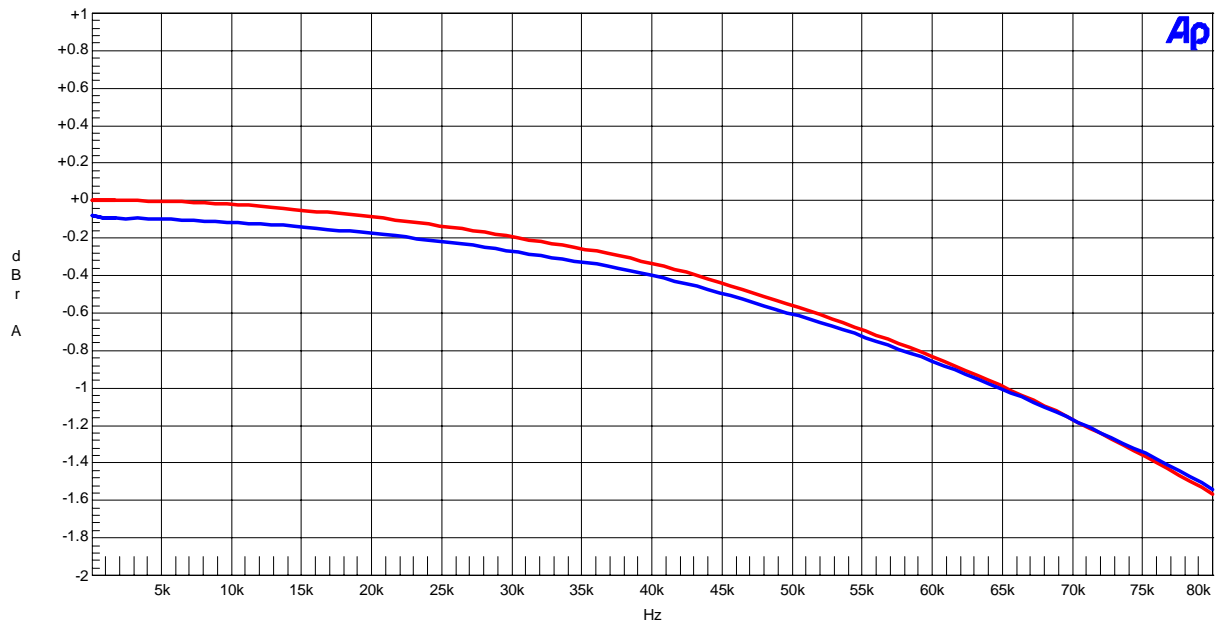

Figure 34 Frequency Response (Input level=0dBFS)

(fs=192kHz)

AKM

AK4396 Cross talk (Red:Lch, Blue:Rch) fs=192kHz
AVDD=DVDD=5V, 0dBFS input

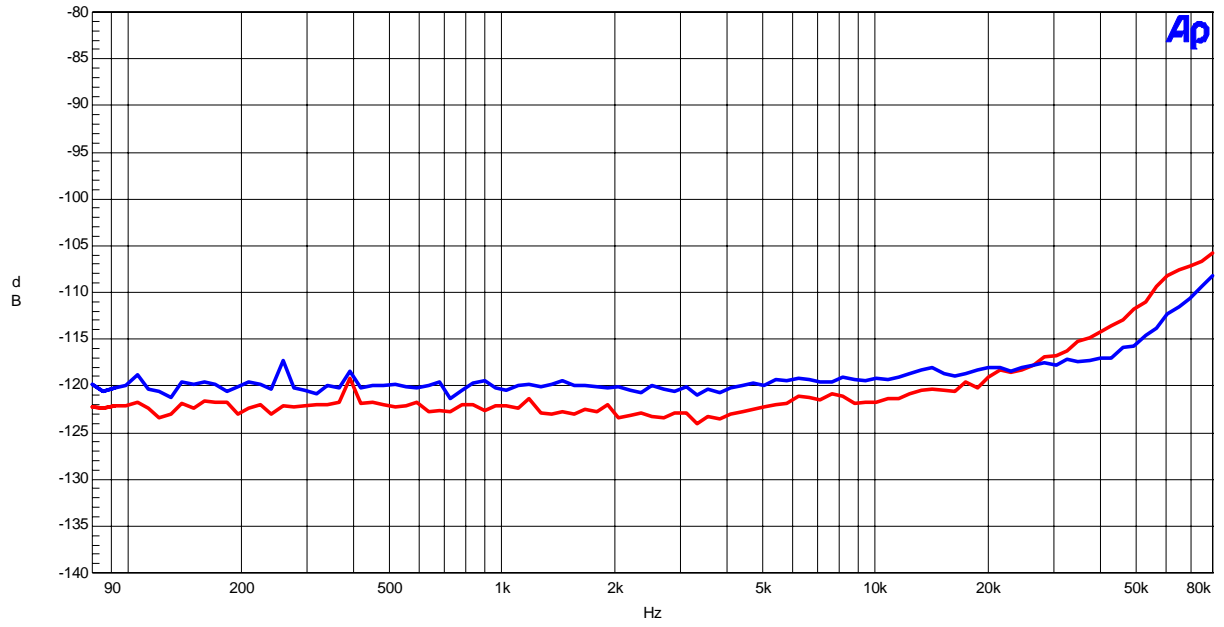

Figure 35 Crosstalk (Input level=0dBFS)

Revision History

Date (YY/MM/DD)	Manual Revision	Board Revision	Reason	Contents
05/03/14	KM078100	0	First edition	
05/03/23	KM078101	1	Modification	Change of circuit
05/06/23	KM078102	2	Modification	Change of circuit

IMPORTANT NOTICE

- These products and their specifications are subject to change without notice. Before considering any use or application, consult the Asahi Kasei Microsystems Co., Ltd. (AKM) sales office or authorized distributor concerning their current status.
- AKM assumes no liability for infringement of any patent, intellectual property, or other right in the application or use of any information contained herein.
- Any export of these products, or devices or systems containing them, may require an export license or other official approval under the law and regulations of the country of export pertaining to customs and tariffs, currency exchange, or strategic materials.
- AKM products are neither intended nor authorized for use as critical components in any safety, life support, or other hazard related device or system, and AKM assumes no responsibility relating to any such use, except with the express written consent of the Representative Director of AKM. As used here:
 - (a) A hazard related device or system is one designed or intended for life support or maintenance of safety or for applications in medicine, aerospace, nuclear energy, or other fields, in which its failure to function or perform may reasonably be expected to result in loss of life or in significant injury or damage to person or property.
 - (b) A critical component is one whose failure to function or perform may reasonably be expected to result, whether directly or indirectly, in the loss of the safety or effectiveness of the device or system containing it, and which must therefore meet very high standards of performance and reliability.
- It is the responsibility of the buyer or distributor of an AKM product who distributes, disposes of, or otherwise places the product with a third party to notify that party in advance of the above content and conditions, and the buyer or distributor agrees to assume any and all responsibility and liability for and hold AKM harmless from any and all claims arising from the use of said product in the absence of such notification.

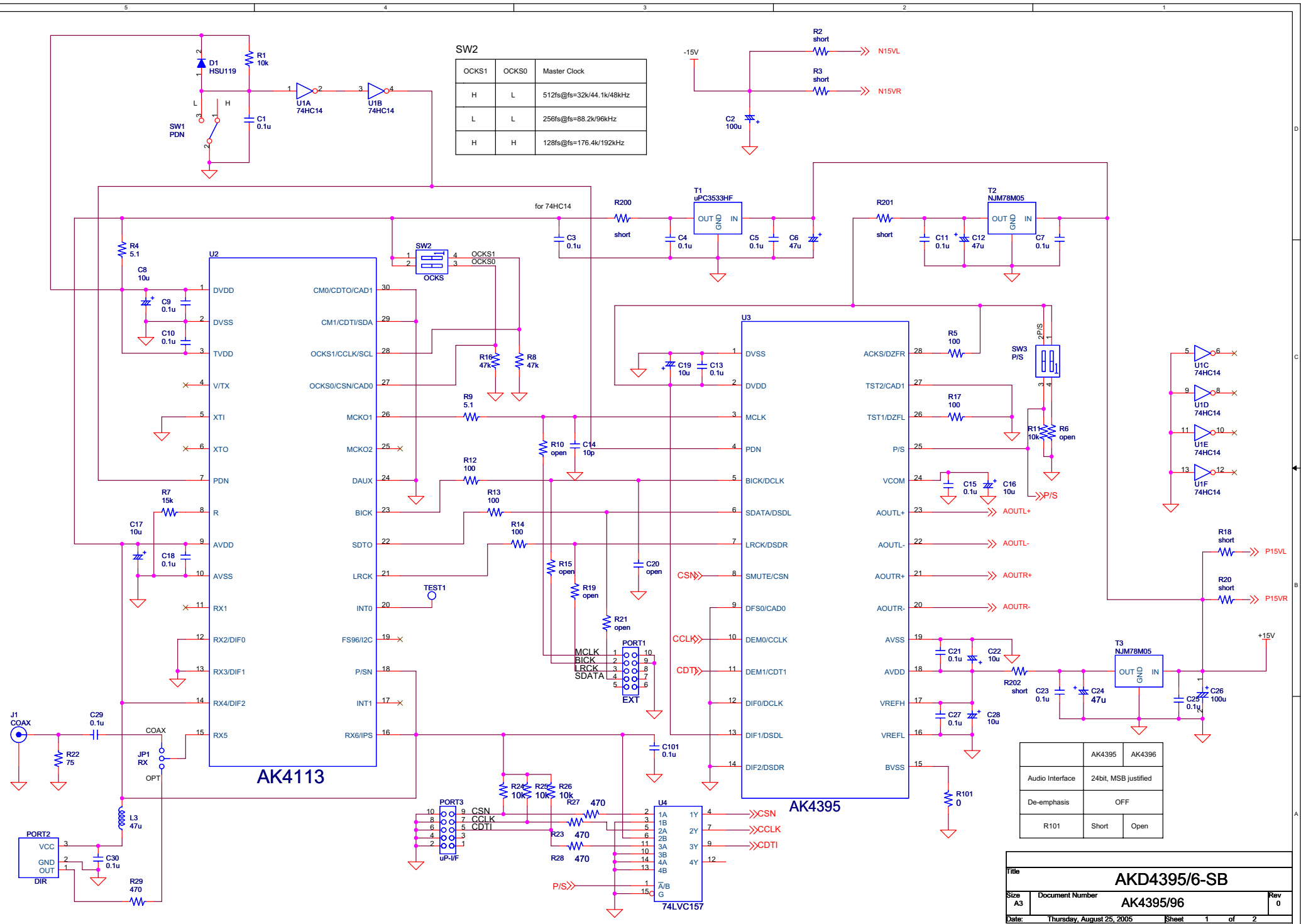

SW2

OCKS1	OCKS0	Master Clock
H	L	512fs@fs=32k/44.1k/48kHz
L	L	256fs@fs=88.2k/96kHz
H	H	128fs@fs=176.4k/192kHz

	AK4395	AK4396
Audio Interface	24bit, MSB justified	
De-emphasis	OFF	
R101	Short	Open

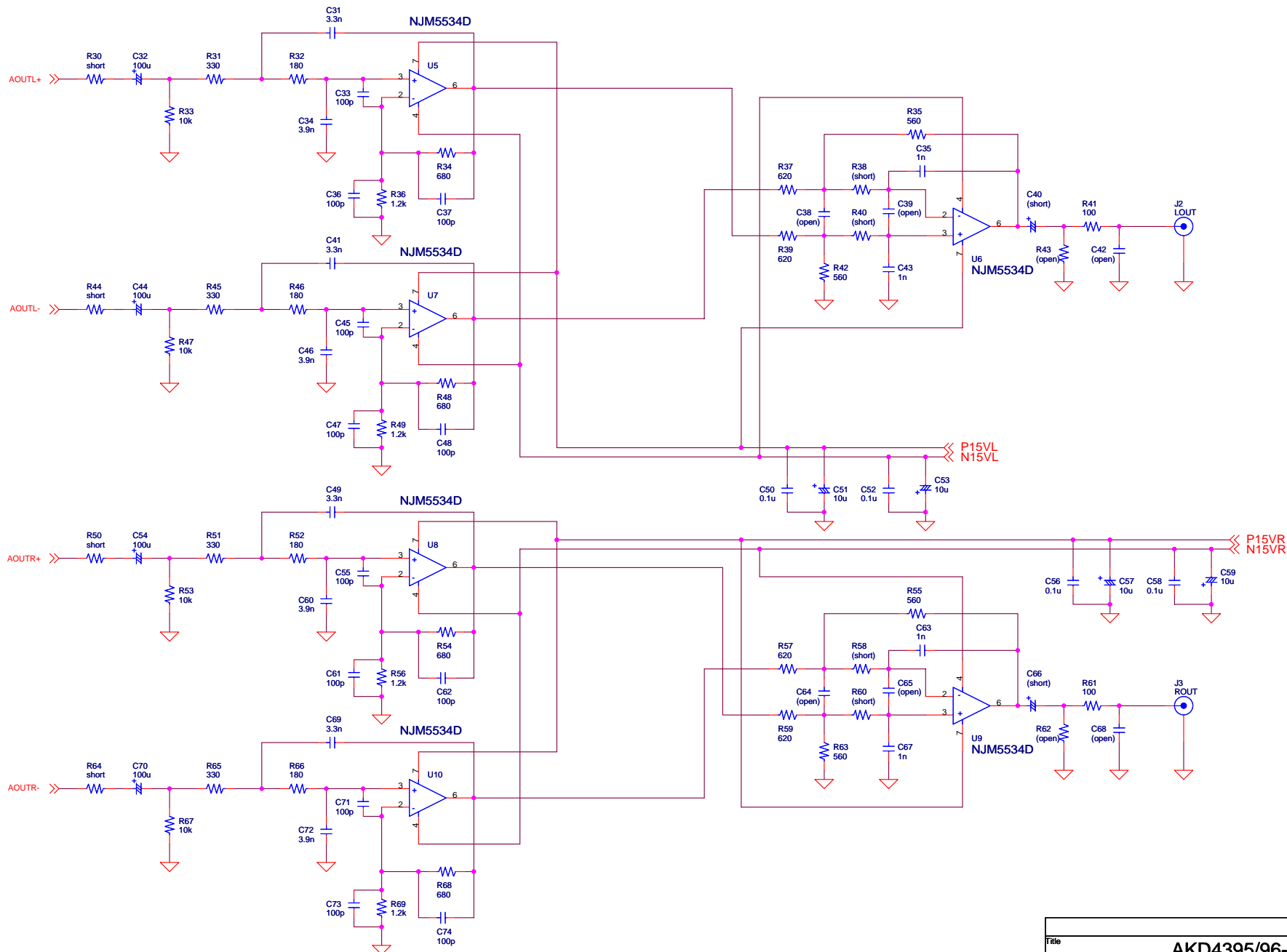

Title		AKD4395/96-SB	
Size	Document Number	Analog	
A3			Rev 0
Date:	Thursday, February 17, 2005	Sheet	2 of 2