

## Optocoupler, Phototransistor Output, AC Input, With Base Connection

### Features

- AC or Polarity Insensitive Inputs
- Continuous Forward Current, 130 mA
- Built-in Reverse Polarity Input Protection
- Improved CTR Symmetry
- Industry Standard DIP Package
- Lead-free component
- Component in accordance to RoHS 2002/95/EC and WEEE 2002/96/EC

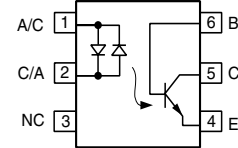
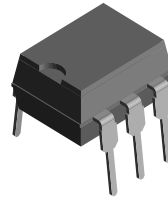

1179010



### Agency Approvals

- UL1577, File No. E52744 System Code H or J, Double Protection
- DIN EN 60747-5-2 (VDE0884)  
DIN EN 60747-5-5 pending  
Available with Option 1
- BSI IEC60950 IEC60065

### Applications

Telecommunications  
Ring Detection  
Loop Current Detector

This optocoupler is ideal for applications requiring AC signal detection and monitoring.

### Order Information

Part	Remarks
IL255	CTR > 20 %, DIP-6
IL255-1	CTR 20 - 80 %, DIP-6
IL255-2	CTR > 50 %, DIP-6
IL255-X007	CTR > 20 %, SMD-6 (option 7)
IL255-X009	CTR > 20 %, SMD-6 (option 9)

For additional information on the available options refer to Option Information.

### Description

The IL255 is a bidirectional input optically coupled isolator consisting of two high current GaAs infrared LEDs coupled to a silicon NPN phototransistor. The IL255 has a minimum CTR of 20 %

### Absolute Maximum Ratings

$T_{amb} = 25\text{ }^{\circ}\text{C}$ , unless otherwise specified

Stresses in excess of the absolute Maximum Ratings can cause permanent damage to the device. Functional operation of the device is not implied at these or any other conditions in excess of those given in the operational sections of this document. Exposure to absolute Maximum Rating for extended periods of the time can adversely affect reliability.

### Input

Parameter	Test condition	Symbol	Value	Unit
Peak pulsed current	1.0 $\mu\text{s}$ , 300 pps	$I_{FP}$	3.0	A
Forward continuous current		$I_F$	130	mA
Power dissipation		$P_{diss}$	175	mW
Derate linearly from 25 $^{\circ}\text{C}$			2.3	mW/ $^{\circ}\text{C}$

### Output

Parameter	Test condition	Symbol	Value	Unit
Collector-emitter breakdown voltage		$BV_{CEO}$	30	V
Emitter-base breakdown voltage		$BV_{EBO}$	5.0	V
Collector-base breakdown voltage		$BV_{CBO}$	70	V
Power dissipation		$P_{diss}$	200	mW
Derate linearly from 25°C			2.6	mW/°C

### Coupler

Parameter	Test condition	Symbol	Value	Unit
Isolation test voltage ( between emitter and detector, refer to standard climate 23 °C/50 %RH, DIN 50014)		$V_{ISO}$	5300	$V_{RMS}$
Creepage			≥ 7.0	mm
Clearance			≥ 7.0	mm
Isolation resistance	$V_{IO} = 500\text{ V}, T_{amb} = 25\text{ °C}$	$R_{IO}$	≥ $10^{12}$	$\Omega$
	$V_{IO} = 500\text{ V}, T_{amb} = 100\text{ °C}$	$R_{IO}$	≥ $10^{11}$	$\Omega$
Total dissipation		$P_{tot}$	250	mW
Derate linearly from 25 °C			3.3	mW/°C
Storage temperature		$T_{stg}$	- 55 to + 150	°C
Operating temperature		$T_{amb}$	- 55 to + 100	°C
Lead soldering time at ≤ 260 °C			10	sec.

### Electrical Characteristics

$T_{amb} = 25\text{ °C}$ , unless otherwise specified

Minimum and maximum values are testing requirements. Typical values are characteristics of the device and are the result of engineering evaluation. Typical values are for information only and are not part of the testing requirements.

### Input

Parameter	Test condition	Symbol	Min	Typ.	Max	Unit
Forward voltage	$I_F = \pm 100\text{ mA}$	$V_F$		1.4	1.7	V

### Output

Parameter	Test condition	Symbol	Min	Typ.	Max	Unit
Collector-emitter breakdown voltage	$I_C = 10\text{ mA}$	$BV_{CEO}$	30	50		V
Emitter-collector breakdown voltage	$I_E = 10\text{ }\mu\text{A}$	$BV_{ECO}$	7.0	10		V
Collector-base breakdown voltage	$I_C = 100\text{ }\mu\text{A}$	$BV_{CBO}$	70			V
Emitter-base breakdown voltage	$I_E = 100\text{ }\mu\text{A}$	$BV_{EBO}$	7.0			V
Collector-emitter leakage current	$V_{CE} = 10\text{ V}$	$I_{CEO}$		5.0	50	nA

### Coupler

Parameter	Test condition	Part	Symbol	Min	Typ.	Max	Unit
Collector-emitter saturation voltage	$I_F = \pm 10 \text{ mA}$ , $I_C = 0.5 \text{ mA}$	IL255	$V_{CE(sat)}$			0.4	V
	$I_F = \pm 100 \text{ mA}$ , $I_C = 1.0 \text{ mA}$	IL255-1	$V_{CE(sat)}$		0.1	0.2	V
	$I_F = \pm 16 \text{ mA}$ , $I_C = 2.0 \text{ mA}$	IL255-2	$V_{CE(sat)}$			0.4	V

### Current Transfer Ratio

Parameter	Test condition	Part	Symbol	Min	Typ.	Max	Unit
Current Transfer Ratio	$I_F = \pm 10 \text{ mA}$ , $V_{CE} = 10 \text{ V}$	IL255	CTR	20			%
	$I_F = \pm 100 \text{ mA}$ , $V_{CE} = 2.0 \text{ V}$	IL255-1	CTR	20		80	%
	$I_F = \pm 10 \text{ mA}$ , $V_{CE} = 10 \text{ V}$	IL255-2	CTR	50			%
Current Transfer Ratio symmetry	$I_F = \pm 10 \text{ mA}$ , $V_{CE} = 10 \text{ V}$	IL255		0.33		3.0	
		IL255-1					
	$I_F = \pm 10 \text{ mA}$ , $V_{CE} = 10 \text{ V}$	IL255-2		0.5	1.0	2.0	

### Typical Characteristics ( $T_{amb} = 25^\circ\text{C}$ unless otherwise specified)

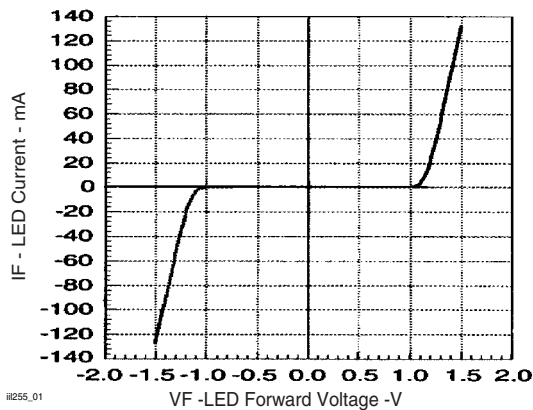

Figure 1. LED Forward Current vs. Forward Voltage

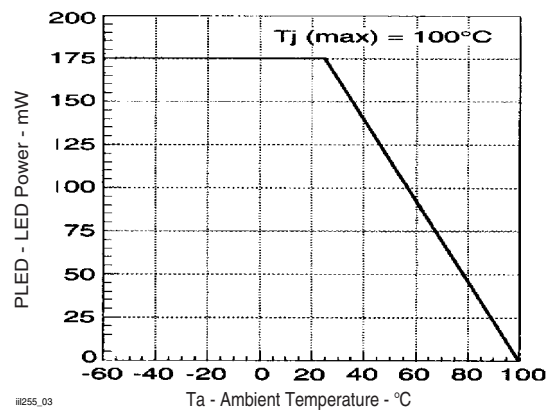

Figure 3. Maximum LED Power Dissipation

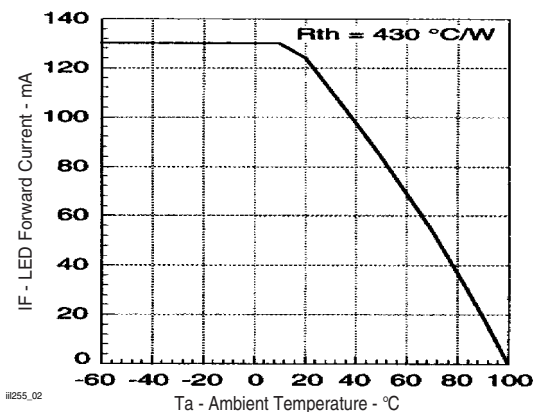

Figure 2. Maximum LED Current vs. Ambient Temperature

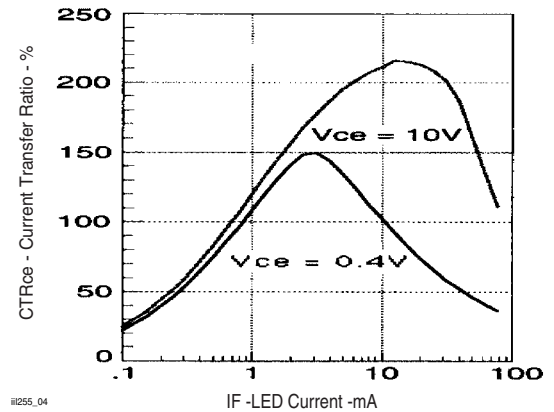
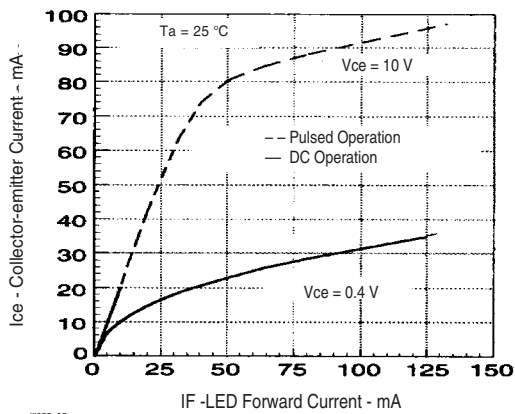
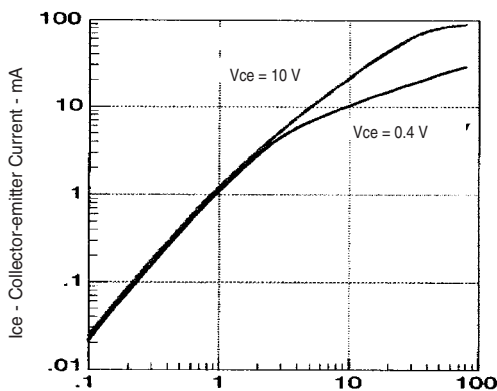

Figure 4. Current Transfer Ratio vs. LED Current and Collector-Emitter Voltage



#255\_05

Figure 5. Non-Saturated and Saturated Collector Emitter Current vs. LED Current



#255\_06

Figure 6. Non-Saturated and Saturated Collector Emitter Current vs. LED Current

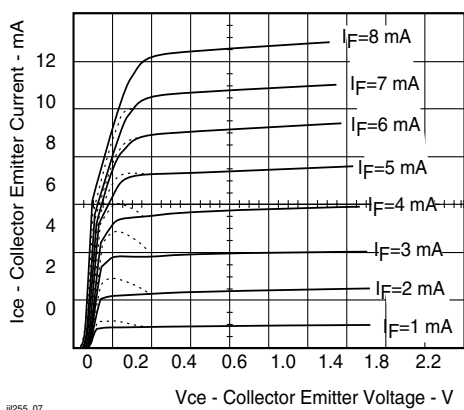

#255\_07

Figure 7. Collector-Emitter Current vs. LED Collector-Emitter Voltage

## Package Dimensions in Inches (mm)

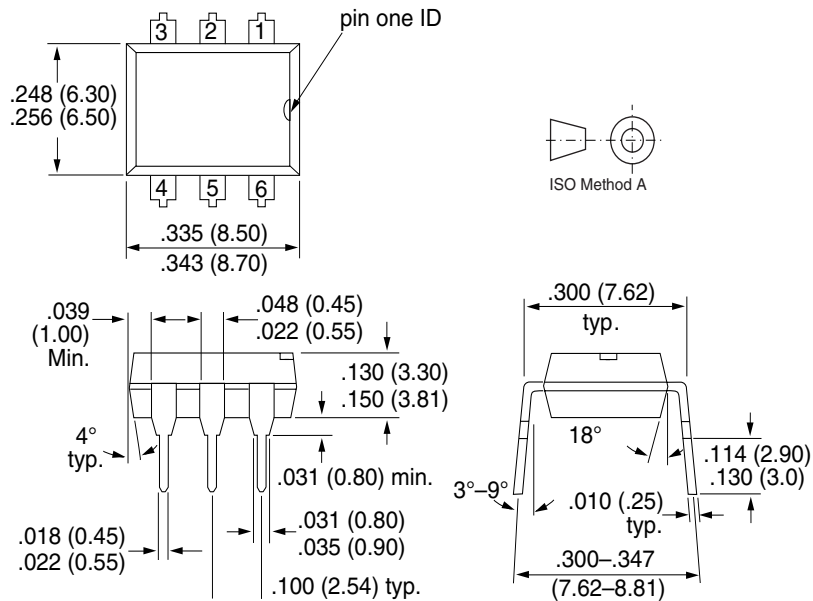

i178004

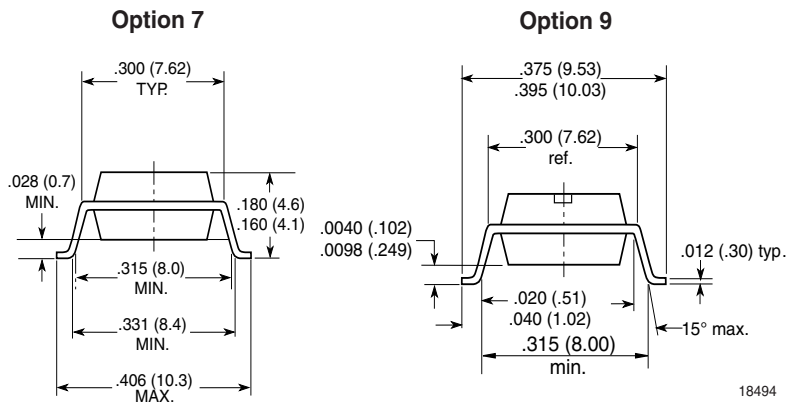

18494

### Ozone Depleting Substances Policy Statement

It is the policy of Vishay Semiconductor GmbH to

1. Meet all present and future national and international statutory requirements.
2. Regularly and continuously improve the performance of our products, processes, distribution and operating systems with respect to their impact on the health and safety of our employees and the public, as well as their impact on the environment.

It is particular concern to control or eliminate releases of those substances into the atmosphere which are known as ozone depleting substances (ODSs).

The Montreal Protocol (1987) and its London Amendments (1990) intend to severely restrict the use of ODSs and forbid their use within the next ten years. Various national and international initiatives are pressing for an earlier ban on these substances.

Vishay Semiconductor GmbH has been able to use its policy of continuous improvements to eliminate the use of ODSs listed in the following documents.

1. Annex A, B and list of transitional substances of the Montreal Protocol and the London Amendments respectively
2. Class I and II ozone depleting substances in the Clean Air Act Amendments of 1990 by the Environmental Protection Agency (EPA) in the USA
3. Council Decision 88/540/EEC and 91/690/EEC Annex A, B and C (transitional substances) respectively.

Vishay Semiconductor GmbH can certify that our semiconductors are not manufactured with ozone depleting substances and do not contain such substances.

We reserve the right to make changes to improve technical design  
and may do so without further notice.

Parameters can vary in different applications. All operating parameters must be validated for each customer application by the customer. Should the buyer use Vishay Semiconductors products for any unintended or unauthorized application, the buyer shall indemnify Vishay Semiconductors against all claims, costs, damages, and expenses, arising out of, directly or indirectly, any claim of personal damage, injury or death associated with such unintended or unauthorized use.

Vishay Semiconductor GmbH, P.O.B. 3535, D-74025 Heilbronn, Germany  
Telephone: 49 (0)7131 67 2831, Fax number: 49 (0)7131 67 2423