

Rail-to-Rail Quad Operational Amplifier

General Description

The RT9134 consists of low cost, high slew rates, single-supply rail-to-rail input and output operation amplifiers. The RT9134 contains four amplifiers in one package.

The RT9134 has high slew rates (12V/μs), 35mA continuous output current, 120mA peak output current and offset voltage below 10mV. The RT9134 is ideal for Thin Film Transistor Liquid Crystal Displays (TFT-LCD).

The RT9134 is available in TSSOP-14 and VQFN-16L 4x4 package and is specified for operation over the full -40°C to +85°C temperature range.

Ordering Information

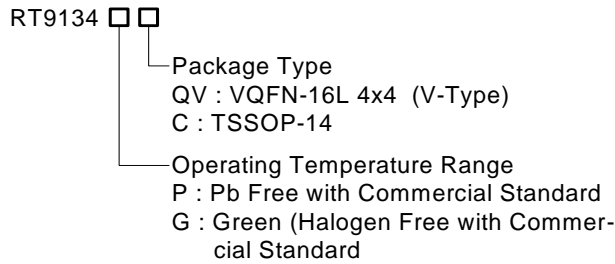

Note :

Richtek Pb-free and Green products are :

- ▶RoHS compliant and compatible with the current requirements of IPC/JEDEC J-STD-020.
- ▶Suitable for use in SnPb or Pb-free soldering processes.
- ▶100% matte tin (Sn) plating.

Function Block Diagram

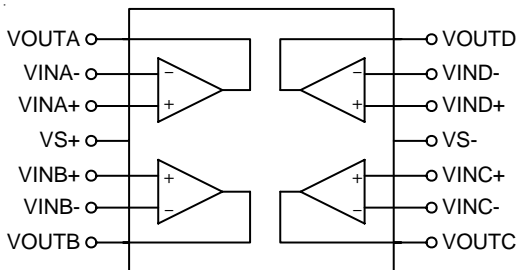

Features

- Rail-to-Rail Output Swing
- Supply Voltage : 4.5V to 15V
- Continuous Output Current : 35mA
- Peak Output Current : 120mA
- High Slew Rate : 12V/μs
- Unity-Gain Stable
- RoHS Compliant and 100% Lead (Pb)-Free

Applications

- TFT-LCD Gamma / V_{COM} Buffer
- Portable Electronic Product
- Communications Product

Pin Configurations

(TOP VIEW)

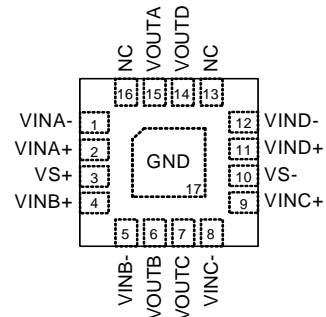

VQFN-16L 4x4

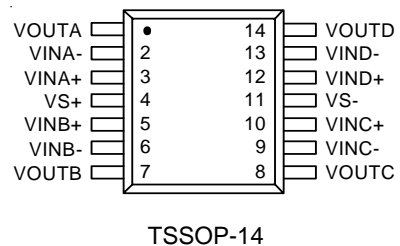

TSSOP-14

Functional Pin Description

Pin No.		Pin Name	Pin Function
RT9134□C	RT9134PQV		
1	15	VOUTA	Amplifier A Output.
2	1	VINA-	Amplifier A Inverting Input.
3	2	VINA+	Amplifier A Non-Inverting Input.
4	3	VS+	Positive Power Supply.
5	4	VINB+	Amplifier B Non-Inverting Input.
6	5	VINB-	Amplifier B Inverting Input.
7	6	VOUTB	Amplifier B Output.
8	7	VOUTC	Amplifier C Output.
9	8	VINC-	Amplifier C Inverting Input.
10	9	VINC+	Amplifier C Non-Inverting Input.
11	10	VS-	Negative Power Supply.
12	11	VIND+	Amplifier D Non-Inverting Input.
13	12	VIND-	Amplifier D Inverting Input.
14	14	VOUTD	Amplifier D Output.
--	16, Exposed Pad (17)	GND	The exposed pad must be soldered to a large PCB and connected to GND for maximum power dissipation.

Absolute Maximum Ratings

- Supply Voltage ----- 17V
- Power Dissipation, P_D @ T_A = 25°C
 - VQFN-16L 4x4 ----- 2315mW
 - TSSOP-14 ----- 1250mW
- Package Thermal Resistance (Note)
 - VQFN-16L 4x4, θ_{JA} ----- 54°C/W
 - TSSOP-14, θ_{JA} ----- 100°C/W
- Input Voltage ----- -0.5V to V_S+0.5V
- Differential Input Voltage ----- V_S
- Storage Temperature Range ----- -65°C to +150°C
- Operating Temperature Range ----- -40°C to +85°C
- Junction Temperature Range ----- -65°C to +150°C

Note : θ_{JA} is measured in the natural convection at T_A = 25°C on a high effective thermal conductivity test board (4-Layers, 2S2P) of JEDEC 51-7 thermal measurement standard.

Electrical Characteristics

($V_S = +5V$, $V_S = -5V$, $R_L = 10k\Omega$ and $C_L = 10pF$ to 0V, $T_A = 25^\circ C$, unless otherwise specified)

Parameter	Symbol	Test Conditions	Min	Typ	Max	Units
Input Characteristics						
Input Offset Voltage	V_{OS}	$V_{CM} = 0$	--	2	15	mV
Average Offset Voltage Drift	$\Delta V_{OS}/\Delta T$	$-40^\circ C \leq T_A \leq 85^\circ C$	--	5	--	$\mu V/^\circ C$
Input Bias Current	I_B	$V_{CM} = 0$	--	2	50	nA
Input Impedance	R_{IN}		--	1	--	$G\Omega$
Input Capacitance	C_{IN}		--	1.35	--	pF
Common-Mode Input Range	CMIR		-5.5	--	+5.5	V
Common-Mode Rejection Ratio	CMRR	For V_{IN} from $-5.5V$ to $+5.5V$	50	80	--	dB
Open-Loop Gain	A_{VOL}	$-4.5V \leq V_{OUT} \leq +4.5V$	75	95	--	dB
Output Characteristics						
Output swing Low	V_{OL}	$I_L = -5mA$	--	-4.92	-4.85	V
Output swing High	V_{OH}	$I_L = +5mA$	4.85	4.92	--	V
Continuous V_{COM} Buffer Output current	I_{OC}		--	± 35	--	mA
Peak V_{COM} Buffer Output current	I_{PC}		--	± 120	--	mA
Power Supply						
Supply Voltage	V_S		4.5	--	15	V
Power Supply Rejection Ratio	PSRR	V_S is moved from $\pm 2.25V$ to $\pm 7.75V$	60	70	--	dB
Supply Current/Amplifier	I_{SY}	No Load	--	500	750	μA
Dynamic Performance						
Slew Rate(Note)	SR	$-4.0V \leq V_{OUT} \leq +4.0V$, 20% to 80%	--	12	--	V/ μs
Setting to $\pm 0.1\%$ ($A_V = +1$)	t_S	($A_V = +1$), $V_{OUT} = 2V$ step	--	500	--	ns
-3dB Bandwidth	BW	$R_L = 10k\Omega$, $C_L = 10 pF$	--	12	--	MHz
Gain-Bandwidth Product	GBWP	$R_L = 10k\Omega$, $C_L = 10 pF$	--	5	--	MHz
Phase Margin	PM	$R_L = 10k\Omega$, $C_L = 10 pF$	--	50	--	$^\circ$
Channel Separation	CS	$f = 5MHz$	--	75	--	dB

Note: Slew rate is measured on rising and falling edges.

(V_{S+} = +2.5V, V_{S-} = -2.5V, R_L = 10kΩ and C_L = 10pF to 2.5V, T_A = 25°C, unless otherwise specified)

Parameter	Symbol	Test Conditions	Min	Typ	Max	Units
Input Characteristics						
Input Offset Voltage	V _{OS}	V _{CM} = 2.5V	--	2	15	mV
Average Offset Voltage Drift	ΔV _{OS} /ΔT	-40°C ≤ T _A ≤ 85°C	--	5	--	uV/°C
Input Bias Current	I _B	V _{CM} = 2.5V	--	2	50	nA
Input Impedance	R _{IN}		--	1	--	GΩ
Input Capacitance	C _{IN}		--	1.35	--	pF
Common-Mode Input Range	CMIR		-0.5	--	+5.5	V
Common-Mode Rejection Ratio	CMRR	For V _{IN} from -0.5V to +5.5V	45	65	--	dB
Open-Loop Gain	A _{VOL}	0.5V ≤ V _{OUT} ≤ +4.5V	75	95	--	dB
Output Characteristics						
Output swing Low	V _{OL}	I _L = -5mA	--	-2.42	-2.35	V
Output swing High	V _{OH}	I _L = +5mA	2.35	2.42	--	V
Continuous V _{COM} Buffer Output current	I _{OC}		--	±35	--	mA
Peak V _{COM} Buffer Output current	I _{PC}		--	±90	--	mA
Power Supply						
Power Supply Rejection Ratio	PSRR	V _S is moved from ±2.25V to ±7.75V	50	70	--	dB
Supply Current/Amplifier	I _{SY}	No Load	--	500	750	uA
Dynamic Performance						
Slew Rate(Note)	SR	-4.0V ≤ V _{OUT} ≤ +4.0V, 20% to 80%	--	12	--	V/us
Setting to ±0.1% (A _V = +1)	t _s	(A _V = +1), V _{OUT} = 2V step	--	500	--	ns
-3dB Bandwidth	BW	R _L = 10kΩ, C _L = 10 pF	--	12	--	MHz
Gain-Bandwidth Product	GBWP	R _L = 10kΩ, C _L = 10 pF	--	5	--	MHz
Phase Margin	PM	R _L = 10kΩ, C _L = 10 pF	--	50	--	°
Channel Separation	CS	f = 5MHz	--	75	--	dB

Note: Slew rate is measured on rising and falling edges.

Typical Operating Characteristics

Quiescent Current vs. Supply Voltage

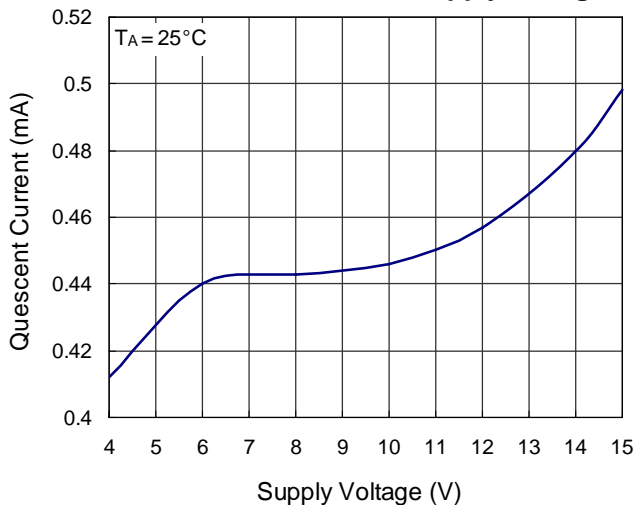

Quiescent current vs. Temperature

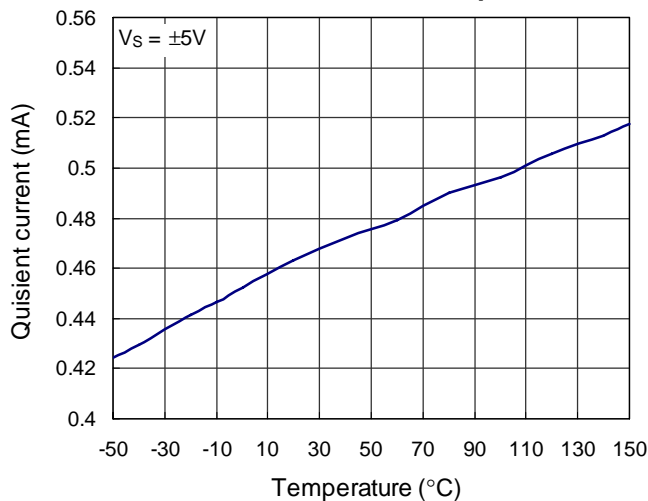

Output High Voltage vs. Temperature

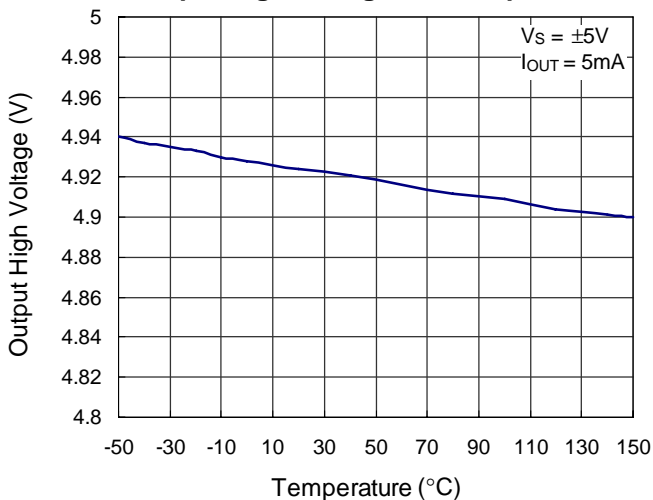

Output Low Voltage vs. Temperature

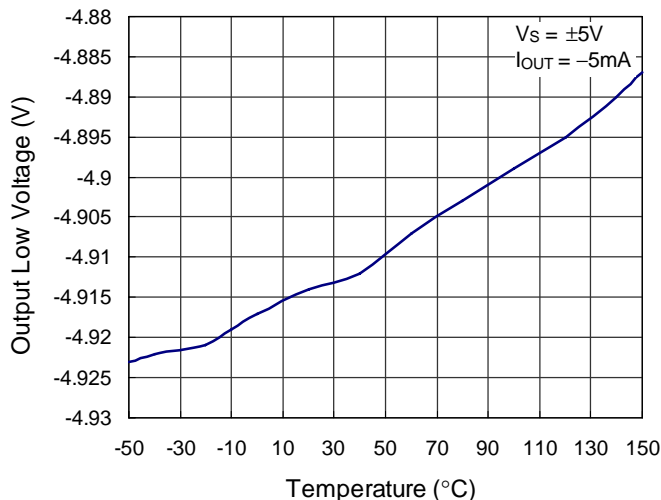

Slew Rate vs. Temperature

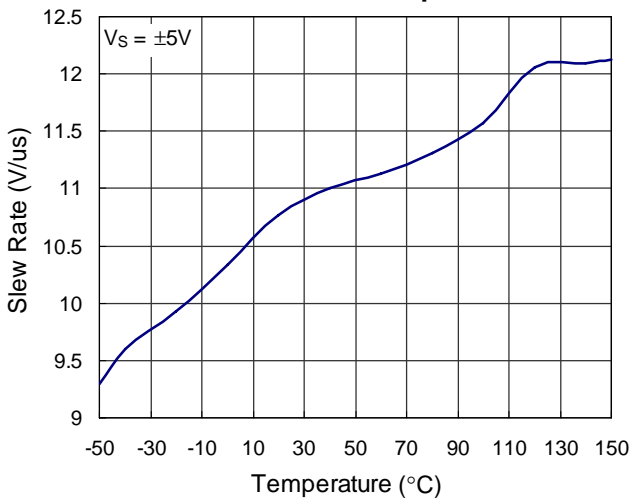

Frequency Response for Various R_L

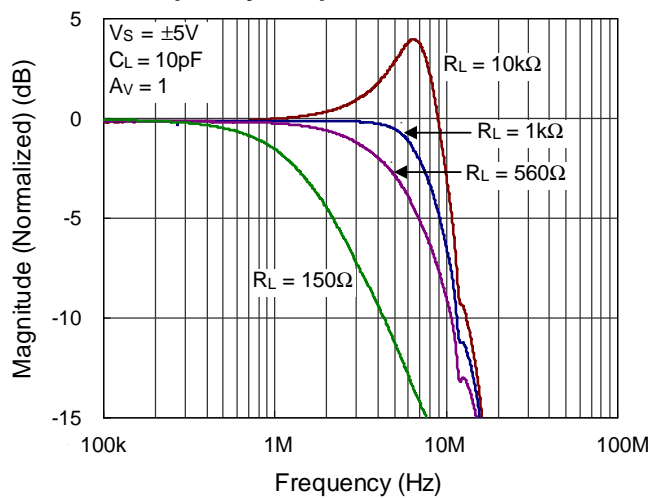

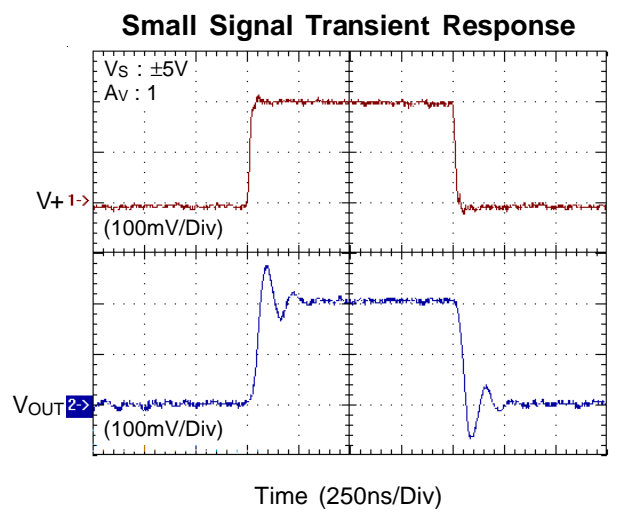
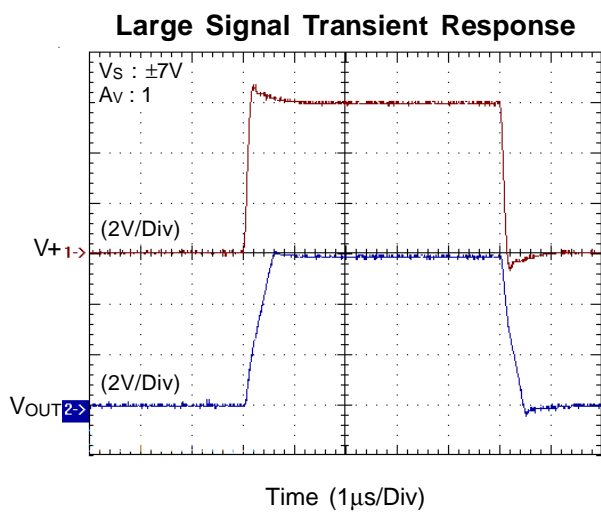
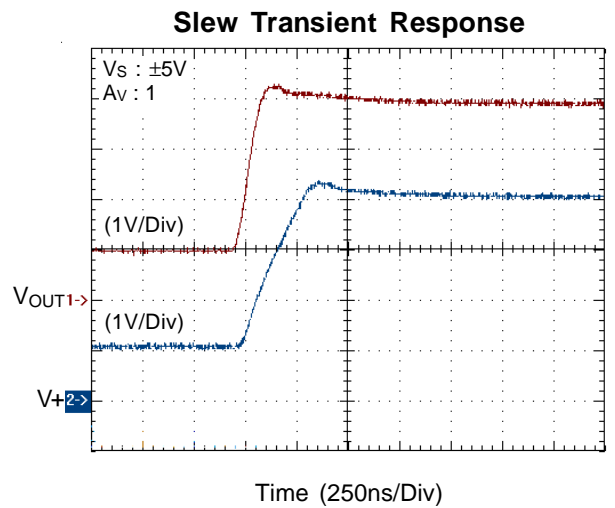
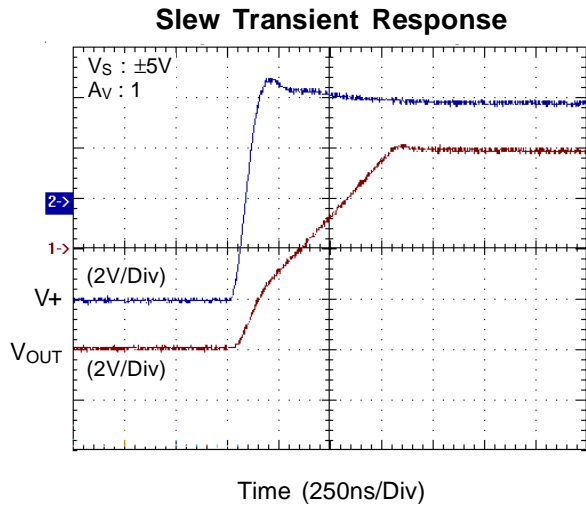
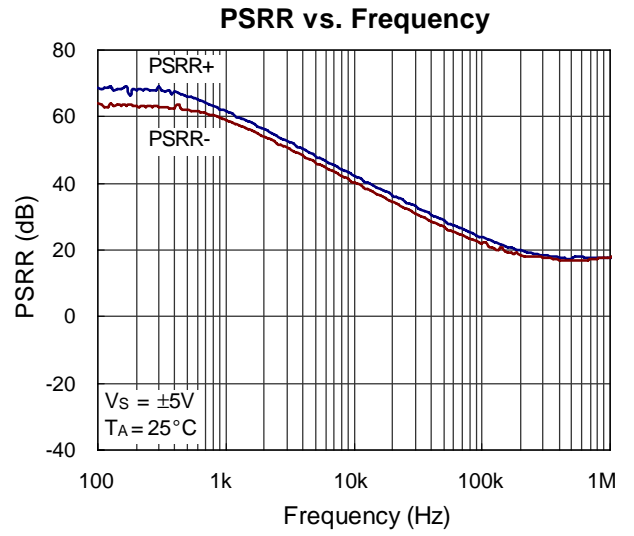
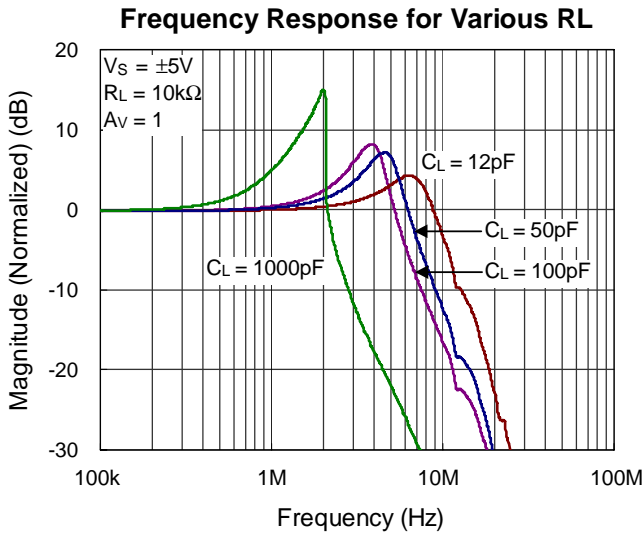

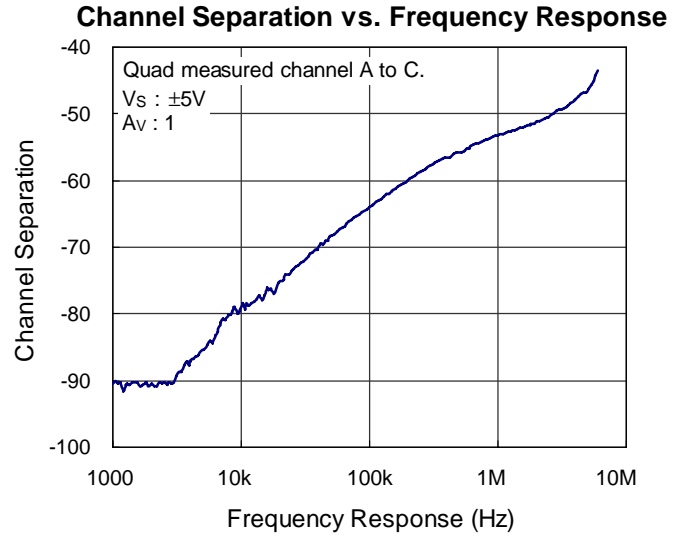
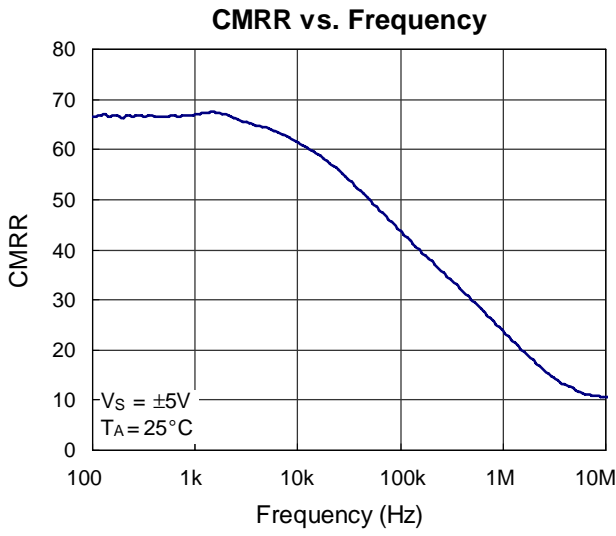

Applications Information

The RT9134 packaged in quad operational amplifiers has high performance to drive large load for different application. High slew rates, rail-to-rail input and output capability and low power consumption are the features to make the RT9134 ideal for LCD applications. The RT9134 also has wide bandwidth and phase margin to drive a load of 10kΩ and 10pF.

Operating Voltage

The RT9134 is specified with single supply voltage from 5V to 15V. According to the electrical characteristics, the total supply voltage range is guaranteed from 4.5V to 15V. To refer the typical operational curves can get stable specifications in wide range of temperature and operating voltage.

The output swing of the RT9134 typically extends to within 80mV of positive/negative supply rails with 5mA load current source/sink. Decreasing the load current will get output swing even closer to the supply rails. Figure 1 shows the rail-to-rail input and output waveforms in the unit gain configuration without load current. The supply rails are +/-5V. Applying an input 10Vp_p sinusoidal waveform results in a 9.8Vp_p output voltage as shown in Figure 1.

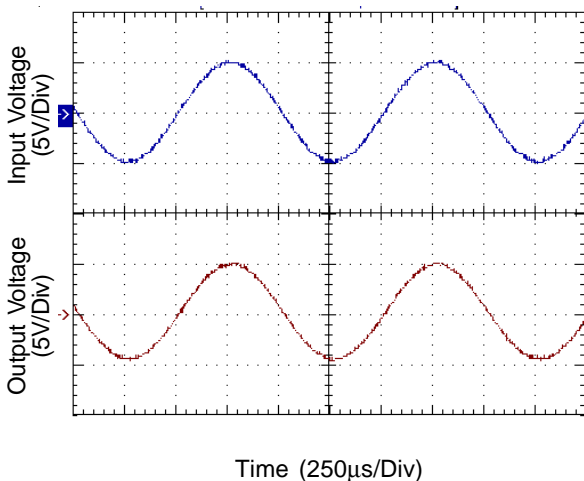

Figure 1. Operation with Rail-to-Rail Input and Output

Power Dissipation

The maximum power dissipation depends on the thermal resistance of IC package, PCB layout, the rate of surroundings airflow and temperature difference between junction to ambient. The maximum power dissipation can be calculated by following formula :

$$P_{D(MAX)} = (T_{J(MAX)} - T_A) / \theta_{JA}$$

Where

$T_{J(MAX)}$: The maximum operation junction temperature 150°C

T_A : The ambient temperature.

θ_{JA} : The junction to ambient thermal resistance.

The recommended operating condition of the RT9134 is below 150°C the maximum junction temperature of the die. The junction to ambient thermal resistance (θ_{JA} is layout dependent) for VQFN-16L 4x4 package is 54°C/W and TSSOP-14 package is 100°C /W on the standard JEDEC 51-7 4-layers thermal test board. The maximum power dissipation at $T_A = 25^\circ\text{C}$ can be calculated by following formula :

$$P_{D(MAX)} = (150^\circ\text{C} - 25^\circ\text{C}) / 54 = 2.315\text{W for rV QFN-16L 4x4 package}$$

$$P_{D(MAX)} = (150^\circ\text{C} - 25^\circ\text{C}) / 100 = 1.250\text{W for TSSOP-14 package}$$

For continuous operation, do not exceed absolute maximum operation junction temperature 150°C. The power dissipation definition for the RT9134 is as following:

$$P_D = (V_S - V_{OUT}) \times I_{Load}$$

V_S : the supply voltage

V_{OUT} : the output voltage

I_{Load} : the output load current

The maximum power dissipation depends on operating ambient temperature for fixed $T_{J(MAX)}$ and thermal resistance θ_{JA} . Figure 2 shows the power dissipation derating curves of the RT9134 with different packages. As the ambient temperature increases, the maximum power dissipation decreases linearly to keep the junction temperature below 150°C.

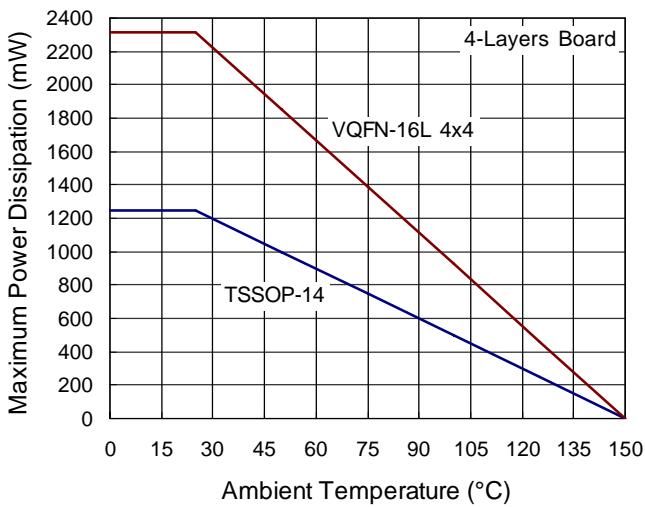

Figure 2. Derating Curves for the RT9134 Package

Short Circuit Condition

An internal short-circuit protection circuit is implemented to protect the device from output short circuit. The RT9134 limits the short circuit current to $\pm 120\text{mA}$ if the output is directly shorted to positive/negative supply rails. For maximum reliability, the maximum continuous output current more than $\pm 35\text{mA}$ is not recommended.

Unused Amplifier

It is recommended to connect the unused amplifier as a unit gain circuit. The negative input is directly connected to the output and the positive input should be connected to the ground.

LCD Panel Applications

The RT9134 is mainly designed for LCD gamma and V-com buffer. OP Amplifier-C has 120mA instantaneous source/sink peak current. To test the performance of the RT9134 for LCD driving capability, the test circuit is to simulate the V-com driver as shown Figure 3. Series capacitors and resistors connected to the output of the OP simulate the load of LCD panel. The 300 Ω and 3k Ω feedback resistors are used to improve the settling time. This circuit is the worst case for a V-com buffer. Figure 4 shows the waveforms of the output peak current capability.

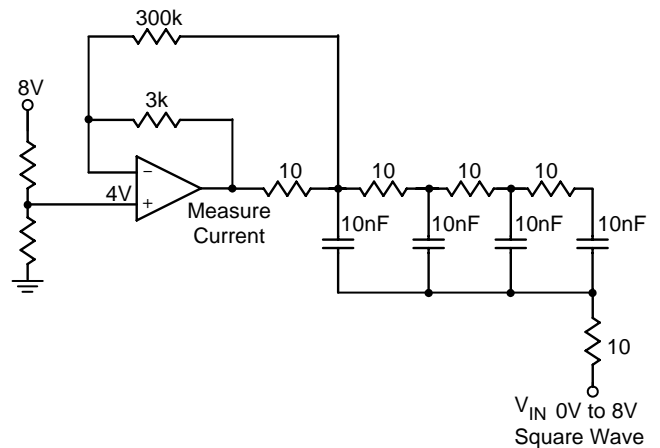

Figure 3. V-com Test Circuit

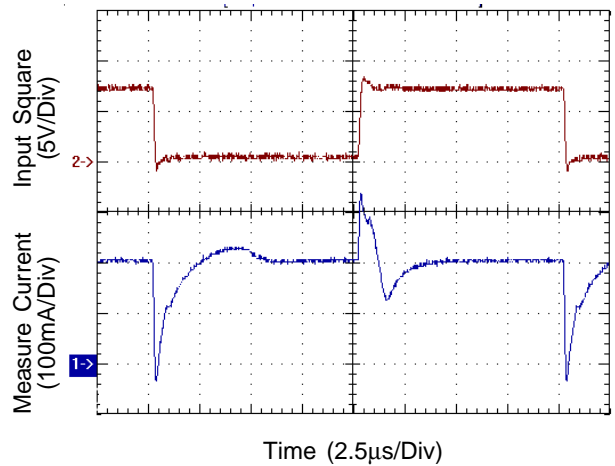
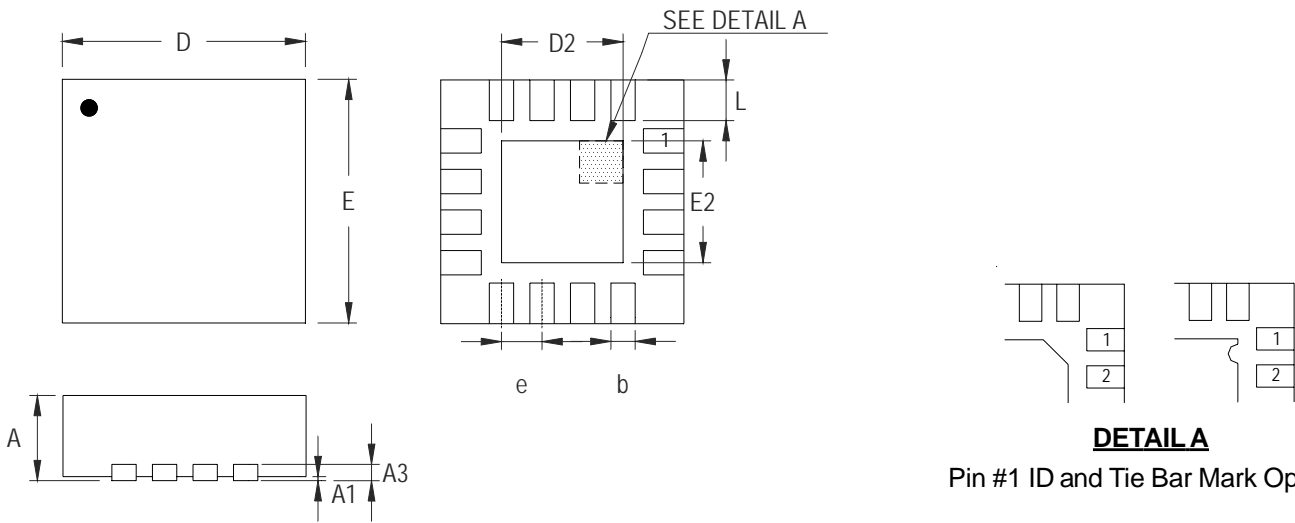

Figure 4. Scope Photo of the V-com Peak Current

Outline Dimension



DETAIL A
Pin #1 ID and Tie Bar Mark Options

Note : The configuration of the Pin #1 identifier is optional, but must be located within the zone indicated.

Symbol	Dimensions In Millimeters		Dimensions In Inches	
	Min	Max	Min	Max
A	0.800	1.000	0.031	0.039
A1	0.000	0.050	0.000	0.002
A3	0.175	0.250	0.007	0.010
b	0.250	0.380	0.010	0.015
D	3.950	4.050	0.156	0.159
D2	2.000	2.450	0.079	0.096
E	3.950	4.050	0.156	0.159
E2	2.000	2.450	0.079	0.096
e	0.650		0.026	
L	0.500	0.600	0.020	0.024

V-Type 16L QFN 4x4 Package

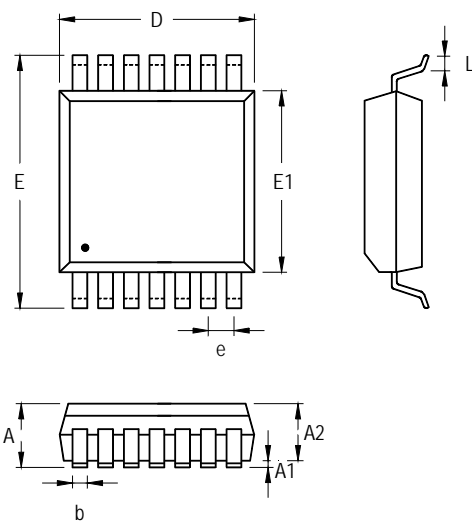

Symbol	Dimensions In Millimeters		Dimensions In Inches	
	Min	Max	Min	Max
A	1.000	1.200	0.039	0.047
A1	0.050	0.150	0.002	0.006
A2	0.800	1.060	0.031	0.042
b	0.190	0.300	0.007	0.012
D	4.900	5.100	0.193	0.201
e	0.650		0.026	
E	6.200	6.600	0.244	0.260
E1	4.300	4.500	0.169	0.177
L	0.450	0.750	0.018	0.030

14-Lead TSSOP Plastic Package

Richtek Technology Corporation

Headquarter
 5F, No. 20, Taiyuen Street, Chupei City
 Hsinchu, Taiwan, R.O.C.
 Tel: (8863)5526789 Fax: (8863)5526611

Richtek Technology Corporation

Taipei Office (Marketing)
 8F, No. 137, Lane 235, Paochiao Road, Hsintien City
 Taipei County, Taiwan, R.O.C.
 Tel: (8862)89191466 Fax: (8862)89191465
 Email: marketing@richtek.com