

ZXMP10A16K

100V DPAK P-channel enhancement mode MOSFET

Summary

$V_{(BR)DSS}$	$R_{DS(on)}$ (Ω)	I_D (A)
-100	0.235 @ $V_{GS} = -10V$	4.6
	0.285 @ $V_{GS} = -6V$	4.2

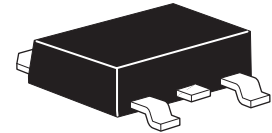

Description

This new generation trench MOSFET from Zetex features a unique structure combining the benefits of low on-resistance and fast switching, making it ideal for high efficiency power management applications.

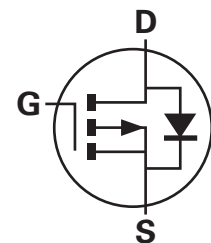

Features

- Low on-resistance
- Fast switching speed
- Low threshold
- Low gate drive
- DPAK package

Applications

- DC-DC converters
- Power management functions
- Disconnect switches
- Motor control

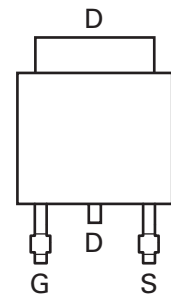

Pinout - top view

Ordering information

Device	Reel size (inches)	Tape width (mm)	Quantity per reel
ZXMP10A16KTC	13	16	2500

Device marking

ZXMP
10A16

ZXMP10A16K

Absolute maximum ratings

Parameter	Symbol	Limit	Unit
Drain-source voltage	V_{DSS}	-100	V
Gate-source voltage	V_{GS}	± 20	V
Continuous drain current @ $V_{GS}=10V$; $T_{amb}=25^{\circ}C^{(b)}$	I_D	4.6	A
@ $V_{GS}=10V$; $T_{amb}=70^{\circ}C^{(b)}$		3.7	
@ $V_{GS}=10V$; $T_{amb}=25^{\circ}C^{(a)}$		3	
Pulsed drain current ^(c)	I_{DM}	15.4	A
Continuous source current (body diode) ^(b)	I_S	10.6	A
Pulsed source current (body diode) ^(c)	I_{SM}	15.4	A
Power dissipation at $T_{amb}=25^{\circ}C^{(a)}$	P_D	4.24	W
Linear derating factor		34	mW/ $^{\circ}C$
Power dissipation at $T_{amb}=25^{\circ}C^{(b)}$	P_D	9.76	W
Linear derating factor		78	mW/ $^{\circ}C$
Power dissipation at $T_{amb}=25^{\circ}C^{(d)}$	P_D	2.15	W
Linear derating factor		16.8	mW/ $^{\circ}C$
Operating and storage temperature range	T_j, T_{stg}	-55 to +150	$^{\circ}C$

Thermal resistance

Parameter	Symbol	Limit	Unit
Junction to ambient ^(a)	$R_{\theta JA}$	29.45	$^{\circ}C/W$
Junction to ambient ^(b)	$R_{\theta JA}$	12.8	$^{\circ}C/W$
Junction to ambient ^(d)	$R_{\theta JA}$	58.1	$^{\circ}C/W$

NOTES:

- (a) For a device surface mounted on 50mm x 50mm x 1.6mm FR4 PCB with high coverage of single sided 2oz copper, in still air conditions.
- (b) For a device surface mounted on FR4 PCB measured at $t \leq 10$ sec.
- (c) Repetitive rating 50mm x 50mm x 1.6mm FR4 PCB, $D=0.02$ pulse width=300 μ s - pulse width limited by maximum junction temperature.
- (d) For a device surface mounted on 25mm x 25mm x 1.6mm FR4 PCB with high coverage of single sided 1oz copper, in still air conditions.

ZXMP10A16K

Typical characteristics

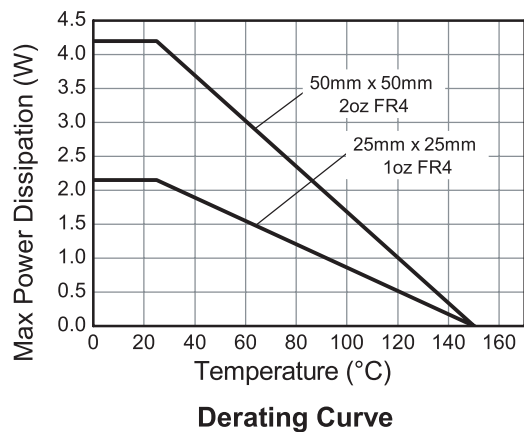
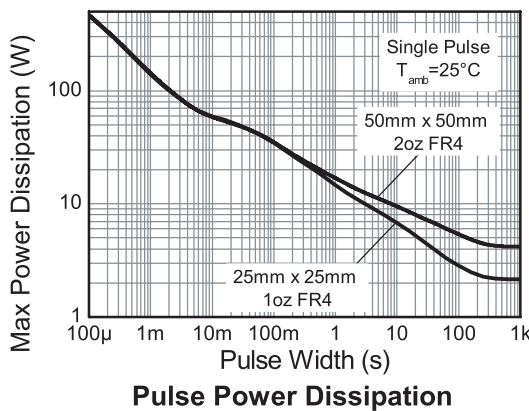
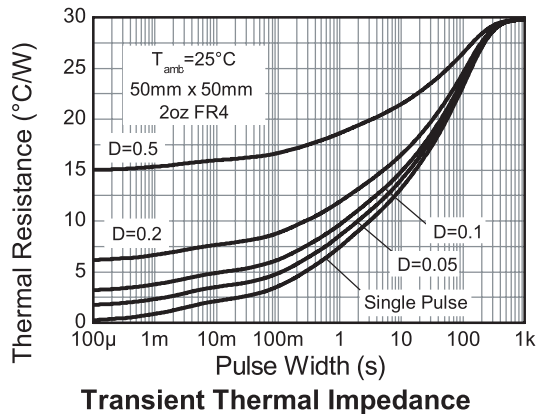
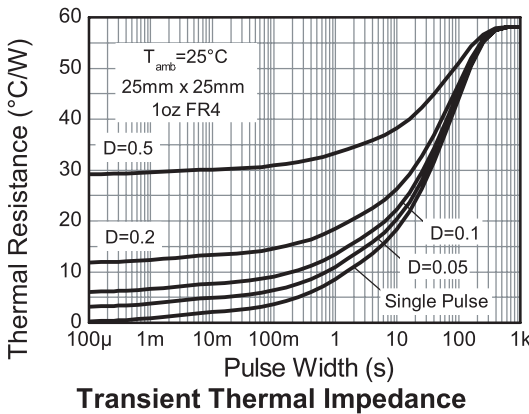
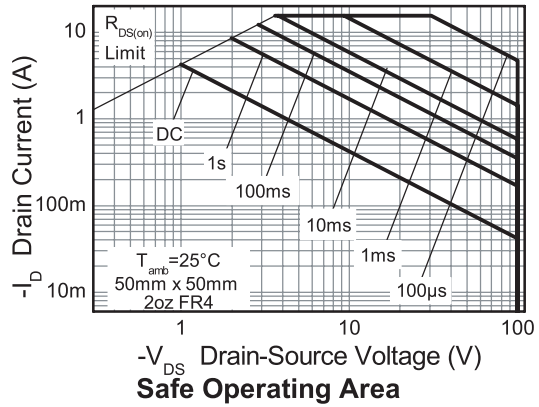
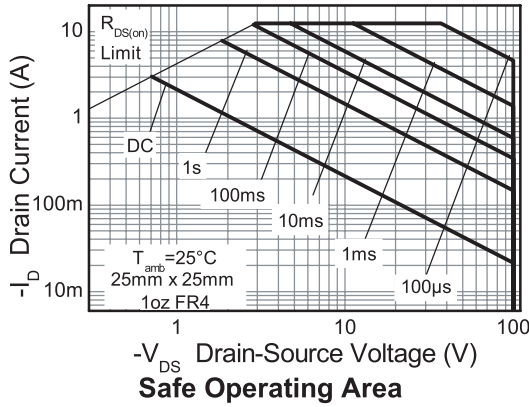

ZXMP10A16K

Electrical characteristics (at $T_{amb} = 25^{\circ}\text{C}$ unless otherwise stated)

Parameter	Symbol	Min.	Typ.	Max.	Unit	Conditions
Static						
Drain-source breakdown voltage	$V_{(BR)DSS}$	-100			V	$I_D = 250\mu\text{A}$, $V_{GS} = 0\text{V}$
Zero gate voltage drain current	I_{DSS}			-1	μA	$V_{DS} = -100\text{V}$, $V_{GS} = 0\text{V}$
Gate-body leakage	I_{GSS}			100	nA	$V_{GS} = \pm 20\text{V}$, $V_{DS} = 0\text{V}$
Gate-source threshold voltage	$V_{GS(th)}$	-2.0		-4.0	V	$I_D = -250\mu\text{A}$, $V_{DS} = V_{GS}$
Static drain-source on-state resistance ^(*)	$R_{DS(on)}$			0.235 0.285	W	$V_{GS} = -10\text{V}$, $I_D = -2.1\text{A}$ $V_{GS} = -6\text{V}$, $I_D = -1.9\text{A}$
Forward transconductance ^(*) (‡)	g_{fs}		4.7		S	$V_{DS} = -15\text{V}$, $I_D = -2.1\text{A}$
Dynamic^(‡)						
Input capacitance	C_{iss}		717		pF	$V_{DS} = -50\text{V}$, $V_{GS} = 0\text{V}$ $f = 1\text{MHz}$
Output capacitance	C_{oss}		55.3		pF	
Reverse transfer capacitance	C_{rss}		46.4		pF	
Switching^(†) (‡)						
Turn-on-delay time	$t_{d(on)}$		4.3		ns	$V_{DD} = -50\text{V}$, $I_D = -1\text{A}$ $R_G = 6.0\Omega$, $V_{GS} = -10\text{V}$
Rise time	t_r		5.2		ns	
Turn-off delay time	$t_{d(off)}$		20		ns	
Fall time	t_f		12.1		ns	
Total gate charge	Q_g		16.5		nC	$V_{DS} = -50\text{V}$, $V_{GS} = -10\text{V}$ $I_D = -2.1\text{A}$
Gate-source charge	Q_{gs}		2.47		nC	
Gate drain charge	Q_{gd}		5.36		nC	
Source-drain diode						
Diode forward voltage ^(*)	V_{SD}		-0.85	-0.95	V	$T_j = 25^{\circ}\text{C}$, $I_S = -3.35\text{A}$, $V_{GS} = 0\text{V}$
Reverse recovery time ^(‡)	t_{rr}		43.3		ns	$T_j = 25^{\circ}\text{C}$, $I_S = -2.4\text{A}$, $di/dt = 100\text{A}/\mu\text{s}$
Reverse recovery charge ^(‡)	Q_{rr}		76.5		nC	

NOTES:

(*) Measured under pulsed conditions. Pulse width $\leq 300\mu\text{s}$; duty cycle $\leq 2\%$.

(†) Switching characteristics are independent of operating junction temperature.

(‡) For design aid only, not subject to production testing.

Typical characteristics

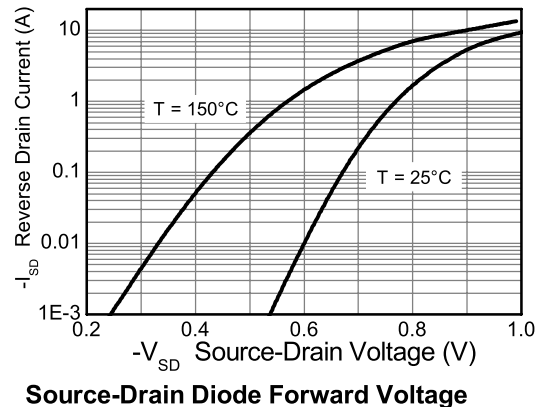
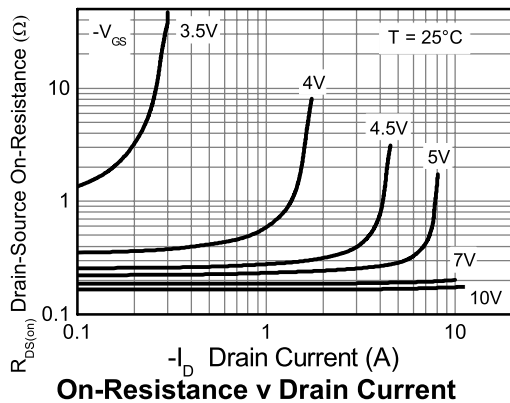
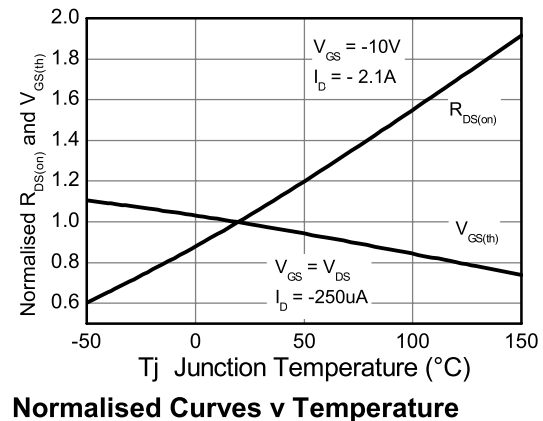
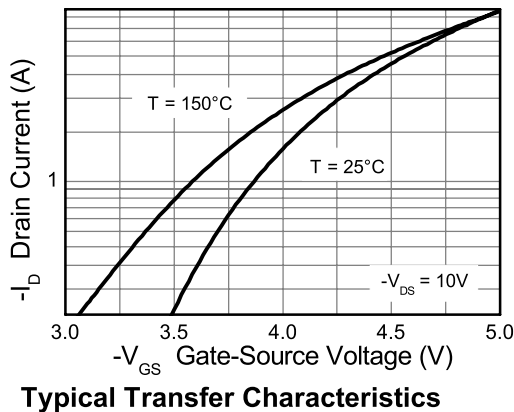
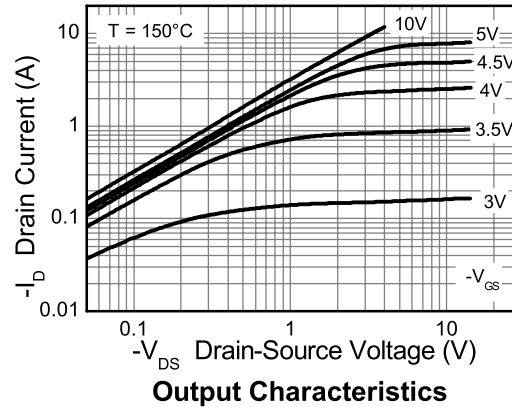
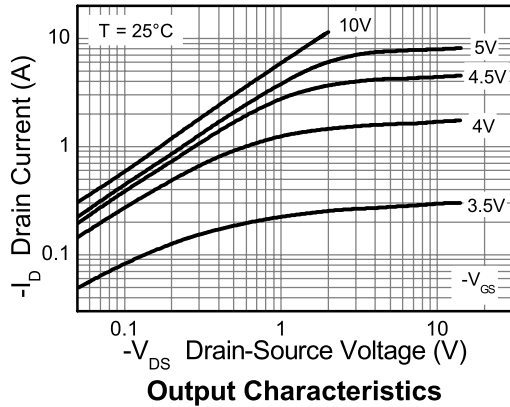

ZXMP10A16K

Typical characteristics

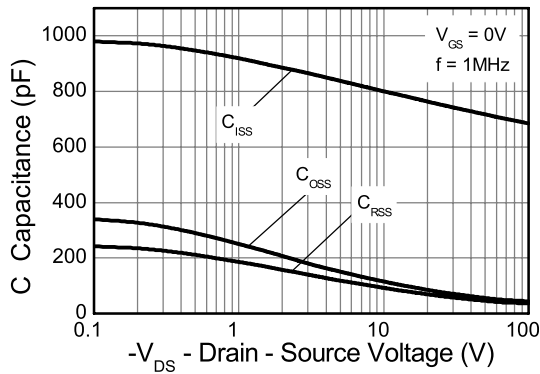

Capacitance v Drain-Source Voltage

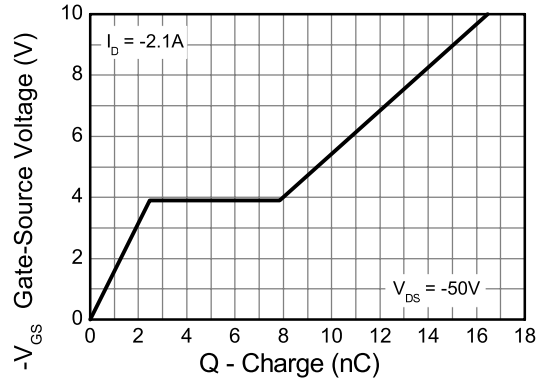

Gate-Source Voltage v Gate Charge

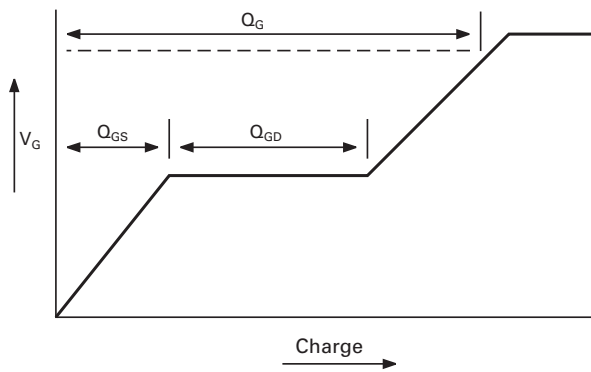

Basic gate charge waveform

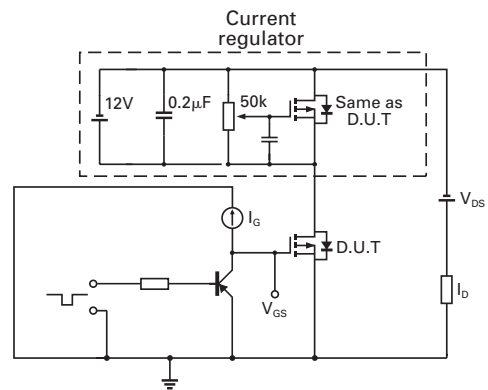

Gate charge test circuit

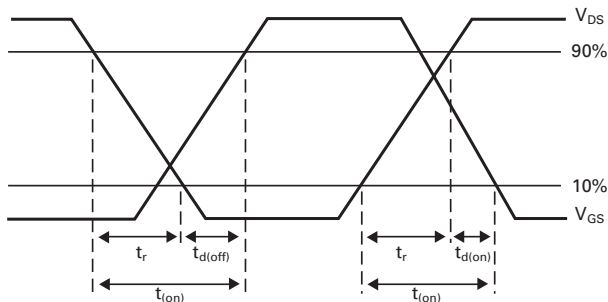

Switching time waveforms

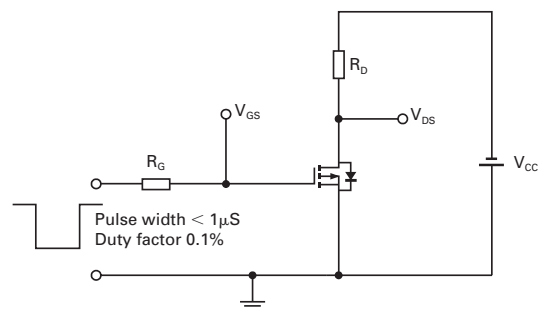

Switching time test circuit

ZXMP10A16K

Intentionally left blank

ZXMP10A16K

Package details - DPAK

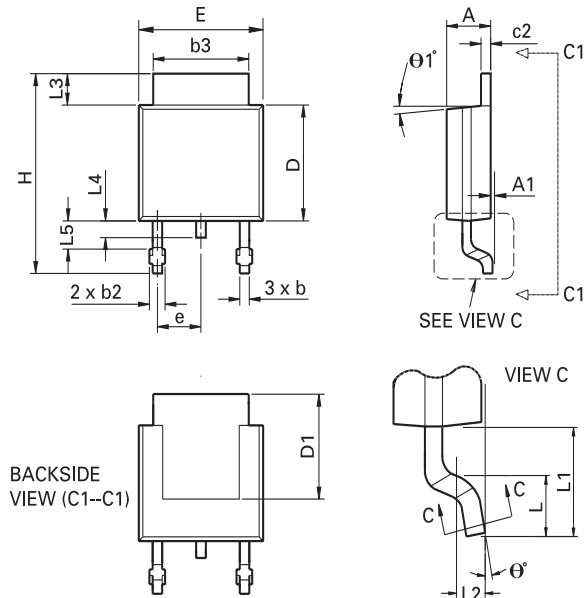

DIM	Inches		Millimeters		DIM	Inches		Millimeters	
	Min	Max	Min	Max		Min	Max	Min	Max
A	0.086	0.094	2.18	2.39	e	0.090 BSC		2.29 BSC	
A1	-	0.005	-	0.127	H	0.370	0.410	9.40	10.41
b	0.020	0.035	0.508	0.89	L	0.055	0.070	1.40	1.78
b2	0.030	0.045	0.762	1.14	L1	0.108 REF		2.74 REF	
b3	0.205	0.215	5.21	5.46	L2	0.020 BSC		0.508 BSC	
c	0.018	0.024	0.457	0.61	L3	0.035	0.065	0.89	1.65
c2	0.018	0.023	0.457	0.584	L4	0.025	0.040	0.635	1.016
D	0.213	0.245	5.41	6.22	L5	0.045	0.060	1.14	1.52
D1	0.205	-	5.21	-	theta 1°	0°	10°	0°	10°
E	0.250	0.265	6.35	6.73	theta 0°	0°	15°	0°	15°
E1	0.170	-	4.32	-	-	-	-	-	-

Note: Controlling dimensions are in inches. Approximate dimensions are provided in millimeters

Europe

Zetex GmbH
Kustermann-park
Balanstraße 59
D-81541 München
Germany
Telephone: (49) 89 45 49 49 0
Fax: (49) 89 45 49 49 49
europe.sales@zetex.com

Americas

Zetex Inc
700 Veterans Memorial Highway
Hauppauge, NY 11788
USA
Telephone: (1) 631 360 2222
Fax: (1) 631 360 8222
usa.sales@zetex.com

Asia Pacific

Zetex (Asia Ltd)
3701-04 Metroplaza Tower 1
Hing Fong Road, Kwai Fong
Hong Kong
Telephone: (852) 26100 611
Fax: (852) 24250 494
asia.sales@zetex.com

Corporate Headquarters

Zetex Semiconductors plc
Zetex Technology Park, Chadderton
Oldham, OL9 9LL
United Kingdom
Telephone: (44) 161 622 4444
Fax: (44) 161 622 4446
hq@zetex.com

For international sales offices visit www.zetex.com/offices

Zetex products are distributed worldwide. For details, see www.zetex.com/salesnetwork

This publication is issued to provide outline information only which (unless agreed by the company in writing) may not be used, applied or reproduced for any purpose or form part of any order or contact or be regarded as a representation relating to the products or services concerned. The company reserves the right to alter without notice the specification, design, price or conditions of supply of any product or service.