

# ZXMP10A18K

## 100V DPAK P-channel enhancement mode MOSFET

### Summary

$V_{(BR)DSS}$	$R_{DS(on)}$ ( $\Omega$ )	$I_D$ (A)
-100	0.150 @ $V_{GS} = -10V$	-5.9
	0.190 @ $V_{GS} = -6V$	-5.2

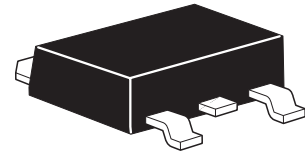

### Description

This new generation trench MOSFET from Zetex features a unique structure combining the benefits of low on-resistance and fast switching, making it ideal for high efficiency power management applications.

### Features

- Low on-resistance
- Fast switching speed
- Low threshold
- Low gate drive
- DPAK package

### Applications

- DC-DC converters
- Power management functions
- Disconnect switches
- Motor control

### Ordering information

Device	Reel size (inches)	Tape width (mm)	Quantity per reel
ZXMP10A18KTC	13	16	2,500

### Device marking

ZXMP  
10A18

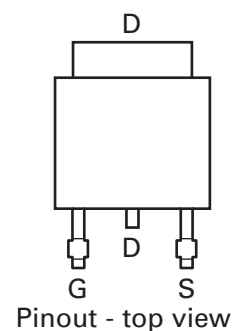
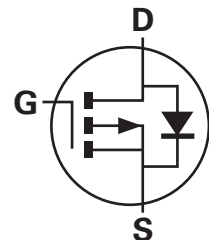

# ZXMP10A18K

## Absolute maximum ratings

Parameter	Symbol	Limit	Unit
Drain-source voltage	$V_{DSS}$	-100	V
Gate-source voltage	$V_{GS}$	$\pm 20$	V
Continuous drain current @ $V_{GS} = 10V$ ; $T_{amb} = 25^{\circ}C^{(b)}$	$I_D$	-5.9	A
@ $V_{GS} = 10V$ ; $T_{amb} = 70^{\circ}C^{(b)}$		-4.7	
@ $V_{GS} = 10V$ ; $T_{amb} = 25^{\circ}C^{(a)}$		-3.8	
Pulsed drain current <sup>(c)</sup>	$I_{DM}$	-21.1	A
Continuous source current (body diode) <sup>(b)</sup>	$I_S$	-10	A
Pulsed source current (body diode) <sup>(c)</sup>	$I_{SM}$	-21.1	A
Power dissipation at $T_{amb} = 25^{\circ}C^{(a)}$	$P_D$	4.3	W
Linear derating factor		34.4	mW/ $^{\circ}C$
Power dissipation at $T_{amb} = 25^{\circ}C^{(b)}$	$P_D$	10.2	W
Linear derating factor		81.3	mW/ $^{\circ}C$
Power dissipation at $T_{amb} = 25^{\circ}C^{(d)}$	$P_D$	2.17	W
Linear derating factor		17.4	mW/ $^{\circ}C$
Operating and storage temperature range	$T_j, T_{stg}$	-55 to +150	$^{\circ}C$

## Thermal resistance

Parameter	Symbol	Limit	Unit
Junction to ambient <sup>(a)</sup>	$R_{\theta JA}$	29	$^{\circ}C/W$
Junction to ambient <sup>(b)</sup>	$R_{\theta JA}$	12.3	$^{\circ}C/W$
Junction to ambient <sup>(d)</sup>	$R_{\theta JA}$	57.6	$^{\circ}C/W$

### NOTES:

- (a) For a device surface mounted on 50mm x 50mm x 1.6mm FR4 PCB with high coverage of single sided 2oz copper, in still air conditions.
- (b) For a device surface mounted on FR4 PCB measured at  $t \leq 10$  sec.
- (c) Repetitive rating 50mm x 50mm x 1.6mm FR4 PCB,  $D=0.02$  pulse width=300 $\mu s$  - pulse width limited by maximum junction temperature.
- (d) For a device surface mounted on 25mm x 25mm x 1.6mm FR4 PCB with high coverage of single sided 1oz copper, in still air conditions.

# ZXMP10A18K

## Thermal characteristics

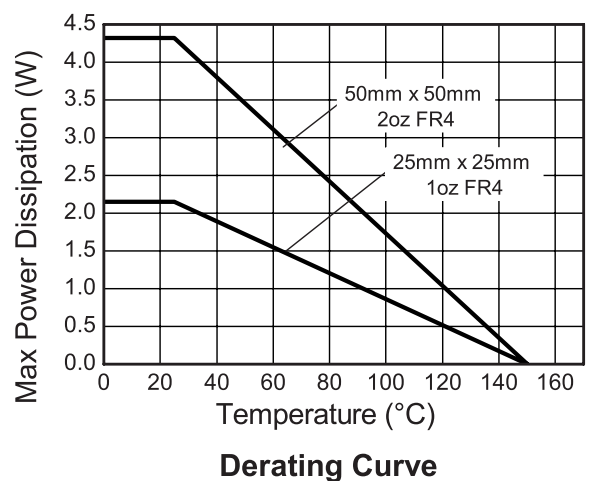
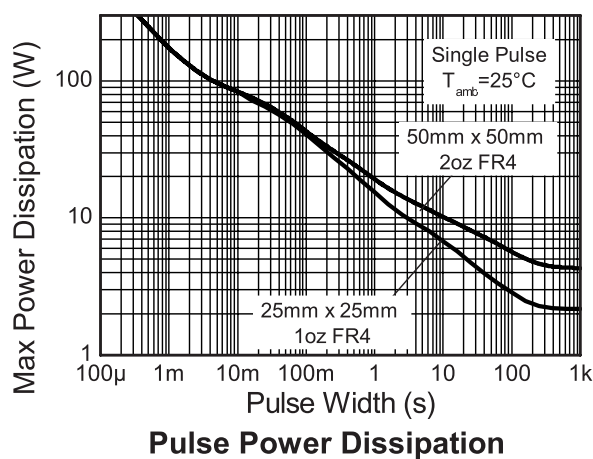
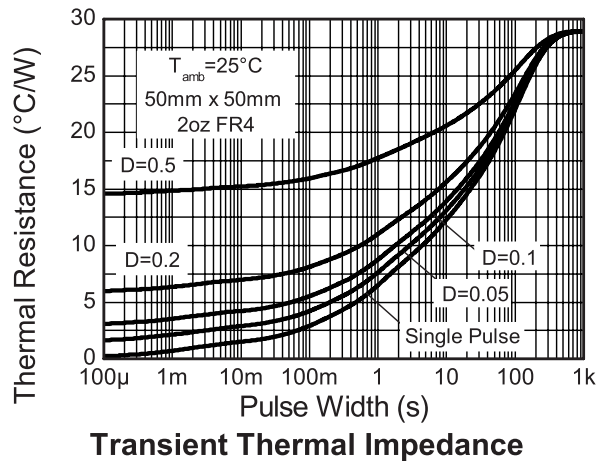
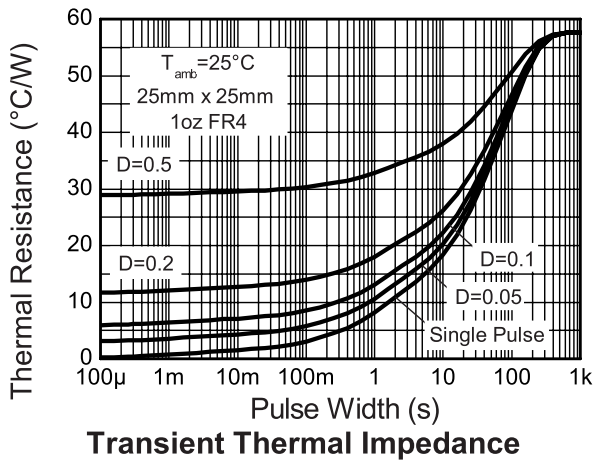
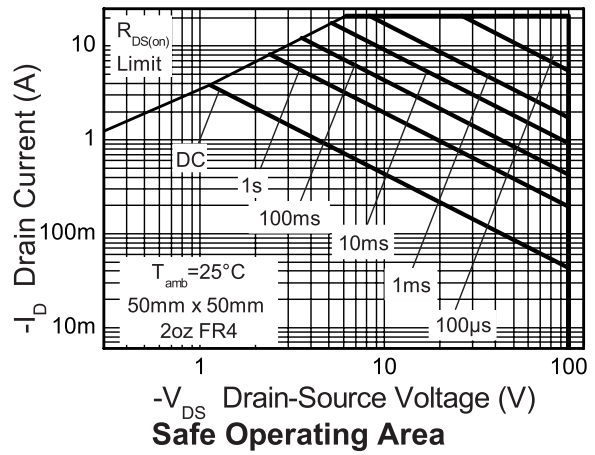
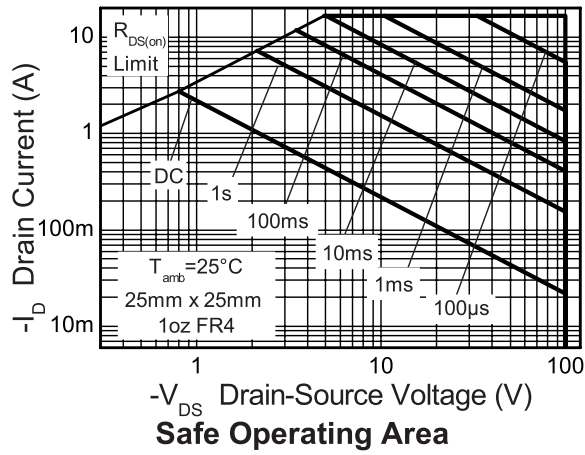

# ZXMP10A18K

## Electrical characteristics (at $T_{amb} = 25^{\circ}\text{C}$ unless otherwise stated)

Parameter	Symbol	Min.	Typ.	Max.	Unit	Conditions
<b>Static</b>						
Drain-source breakdown voltage	$V_{(BR)DSS}$	-100			V	$I_D = -250\mu\text{A}$ , $V_{GS} = 0\text{V}$
Zero gate voltage drain current	$I_{DSS}$			-1	$\mu\text{A}$	$V_{DS} = -100\text{V}$ , $V_{GS} = 0\text{V}$
Gate-body leakage	$I_{GSS}$			100	nA	$V_{GS} = \pm 20\text{V}$ , $V_{DS} = 0\text{V}$
Gate-source threshold voltage	$V_{GS(th)}$	-2.0		-4.0	V	$I_D = -250\mu\text{A}$ , $V_{DS} = V_{GS}$
Static drain-source on-state resistance <sup>(*)</sup>	$R_{DS(on)}$			0.150 0.190	$\Omega$	$V_{GS} = -10\text{V}$ , $I_D = -2.8\text{A}$ $V_{GS} = -6\text{V}$ , $I_D = -2.4\text{A}$
Forward transconductance <sup>(*)(‡)</sup>	$g_{fs}$		6.0		S	$V_{DS} = -15\text{V}$ , $I_D = -2.8\text{A}$
<b>Dynamic<sup>(‡)</sup> (3)</b>						
Input capacitance	$C_{iss}$		1055		pF	$V_{DS} = -50\text{V}$ , $V_{GS} = 0\text{V}$ $f = 1\text{MHz}$
Output capacitance	$C_{oss}$		90		pF	
Reverse transfer capacitance	$C_{rss}$		76		pF	
<b>Switching<sup>(†)</sup> (‡)</b>						
Turn-on-delay time	$t_{d(on)}$		4.9		ns	$V_{DD} = -50\text{V}$ , $I_D = -1\text{A}$ $R_G = 6.0\Omega$ , $V_{GS} = -10\text{V}$
Rise time	$t_r$		6.8		ns	
Turn-off delay time	$t_{d(off)}$		33.9		ns	
Fall time	$t_f$		17.9		ns	
Total gate charge	$Q_g$		26.9		nC	$V_{DS} = -50\text{V}$ , $V_{GS} = -10\text{V}$ $I_D = -2.8\text{A}$
Gate-source charge	$Q_{gs}$		3.9		nC	
Gate drain charge	$Q_{gd}$		10.2		nC	
<b>Source-drain diode</b>						
Diode forward voltage <sup>(*)</sup>	$V_{SD}$		-0.85	-0.95	V	$T_j = 25^{\circ}\text{C}$ , $I_S = -3.5\text{A}$ , $V_{GS} = 0\text{V}$
Reverse recovery time <sup>(‡)</sup>	$t_{rr}$		49		ns	$T_j = 25^{\circ}\text{C}$ , $I_S = -2.8\text{A}$ , $di/dt = 100\text{A/ms}$
Reverse recovery charge <sup>(‡)</sup>	$Q_{rr}$		107		nC	

### NOTES:

(\*) Measured under pulsed conditions. Pulse width  $\leq 300\mu\text{s}$ ; duty cycle  $\leq 2\%$

(†) Switching characteristics are independent of operating junction temperature.

(‡) For design aid only, not subject to production testing.

## Typical characteristics

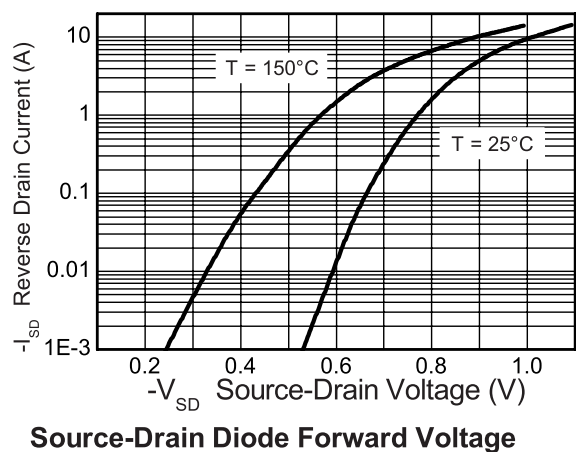
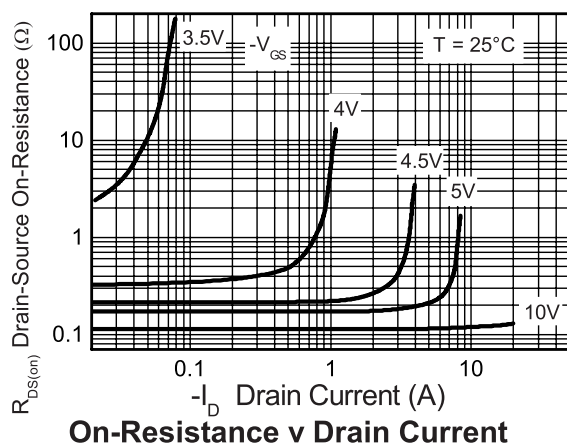
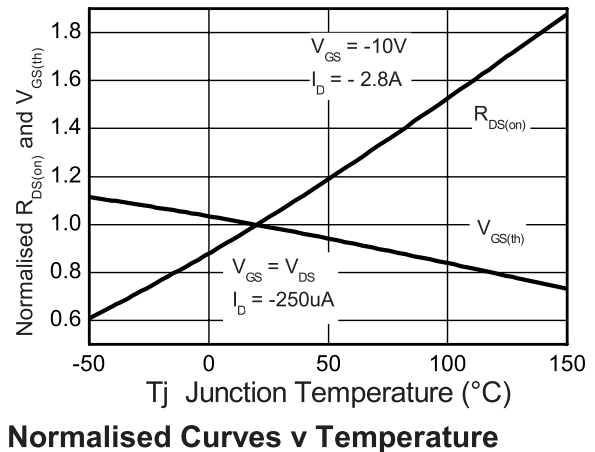
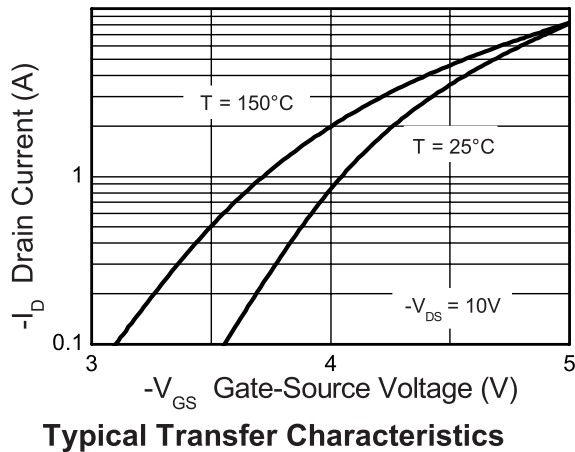
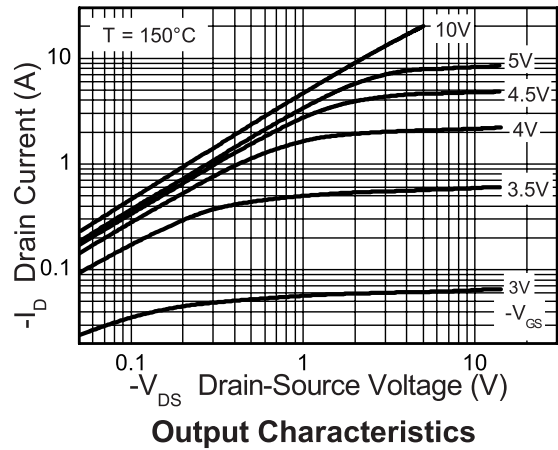
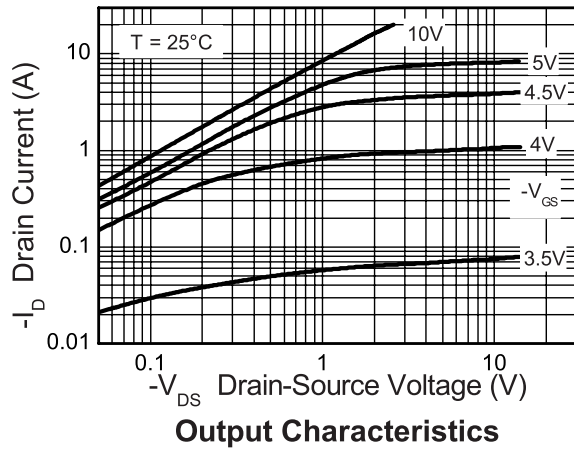

## Typical characteristics

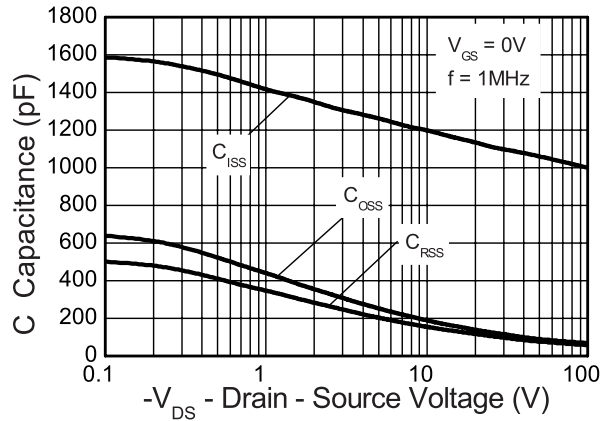

Capacitance v Drain-Source Voltage

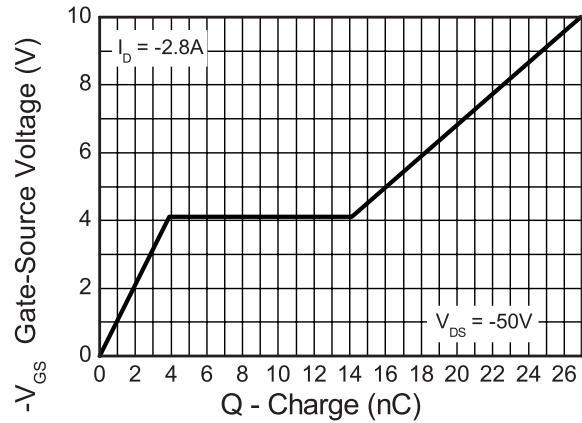

Gate-Source Voltage v Gate Charge

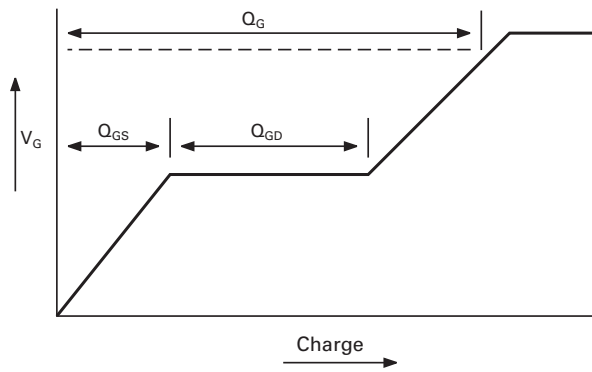

Basic gate charge waveform

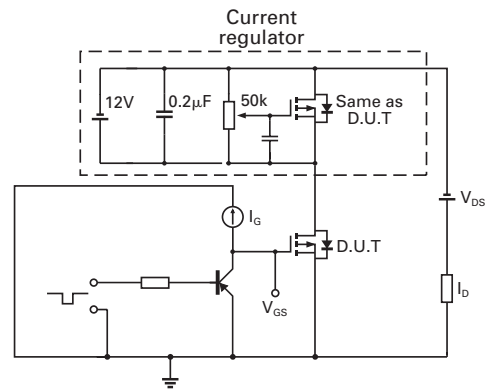

Gate charge test circuit

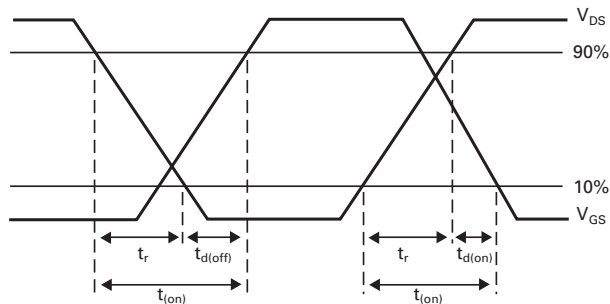

Switching time waveforms

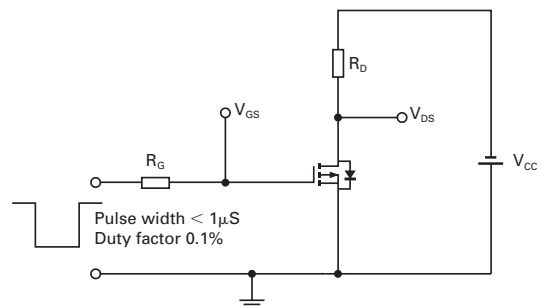

Switching time test circuit

# ZXMP10A18K

Intentionally left blank

# ZXMP10A18K

## Package outline - DPAK

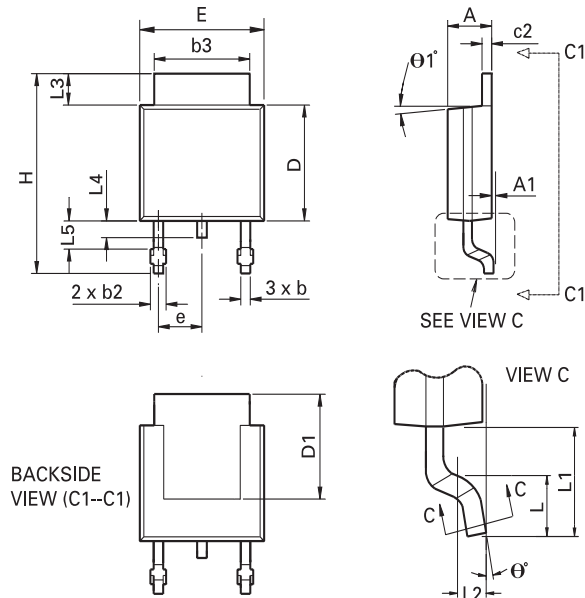

DIM	Inches		Millimeters		DIM	Inches		Millimeters	
	Min	Max	Min	Max		Min	Max	Min	Max
A	0.086	0.094	2.18	2.39	e	0.090 BSC		2.29 BSC	
A1	-	0.005	-	0.127	H	0.370	0.410	9.40	10.41
b	0.020	0.035	0.508	0.89	L	0.055	0.070	1.40	1.78
b2	0.030	0.045	0.762	1.14	L1	0.108 REF		2.74 REF	
b3	0.205	0.215	5.21	5.46	L2	0.020 BSC		0.508 BSC	
c	0.018	0.024	0.457	0.61	L3	0.035	0.065	0.89	1.65
c2	0.018	0.023	0.457	0.584	L4	0.025	0.040	0.635	1.016
D	0.213	0.245	5.41	6.22	L5	0.045	0.060	1.14	1.52
D1	0.205	-	5.21	-	theta 1°	0°	10°	0°	10°
E	0.250	0.265	6.35	6.73	theta 0°	0°	15°	0°	15°
E1	0.170	-	4.32	-	-	-	-	-	-

**Note:** Controlling dimensions are in inches. Approximate dimensions are provided in millimeters

### Europe

Zetex GmbH  
Streitfeldstraße 19  
D-81673 München  
Germany

Telefon: (49) 89 45 49 49 0  
Fax: (49) 89 45 49 49 49  
europe.sales@zetex.com

### Americas

Zetex Inc  
700 Veterans Memorial Highway  
Hauppauge, NY 11788  
USA

Telephone: (1) 631 360 2222  
Fax: (1) 631 360 8222  
usa.sales@zetex.com

### Asia Pacific

Zetex (Asia Ltd)  
3701-04 Metroplaza Tower 1  
Hing Fong Road, Kwai Fong  
Hong Kong

Telephone: (852) 26100 611  
Fax: (852) 24250 494  
asia.sales@zetex.com

### Corporate Headquarters

Zetex Semiconductors plc  
Zetex Technology Park, Chadderton  
Oldham, OL9 9LL  
United Kingdom

Telephone: (44) 161 622 4444  
Fax: (44) 161 622 4446  
hq@zetex.com

For international sales offices visit [www.zetex.com/offices](http://www.zetex.com/offices)

Zetex products are distributed worldwide. For details, see [www.zetex.com/salesnetwork](http://www.zetex.com/salesnetwork)

This publication is issued to provide outline information only which (unless agreed by the company in writing) may not be used, applied or reproduced for any purpose or form part of any order or contact or be regarded as a representation relating to the products or services concerned. The company reserves the right to alter without notice the specification, design, price or conditions of supply of any product or service.