

# International IOR Rectifier

## BAT54

### SCHOTTKY DIODE

0.2 Amp

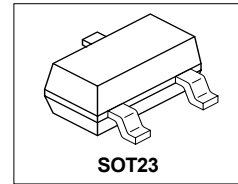

#### Major Ratings and Characteristics

Characteristics	Value	Units
$I_F$ (DC)	0.2	A
$V_{RRM}$	30	V
$I_{FSM}$ @ $t_p = 10$ ms sine	1.0	A
$V_F$ @ 30mA DC, $T_J = 25^\circ\text{C}$	0.5	V
$P_d$ Power Dissipation @ $T_A = 25^\circ\text{C}$	200	mW
$T_J$ range	- 65 to 150	$^\circ\text{C}$

#### Description/ Features

This Schottky barrier diode is designed for high speed switching application, voltage clamping and circuit protection. Miniature surface mount packages with reduced foot print are excellent for portable application where space is limited

- Small foot print, surface mountable
- Very low forward voltage drop
- Extremely fast switching speed for high frequency operation
- Guard ring for enhanced ruggedness and long term reliability

#### Case Styles

Device Marking: IR54

DIM	Millimeters		Inches	
	Min	Max	Min	Max
A	0.37	0.51	0.015	0.020
B	1.20	1.40	0.047	0.055
C	2.30	2.50	0.091	0.098
D	0.89	1.03	0.035	0.041
F	0.45	0.60	0.018	0.024
H	2.80	3.00	1.110	0.118
J	0.013	0.10	0.001	0.004
K	0.89	1.10	0.035	0.043
L	0.45	0.61	0.018	0.024
M	0.09	0.18	0.003	0.007
$\alpha$	8°		8°	

**Outline SOT23**

# BAT54

Preliminary Data Sheet PD-20761 12/01



## Voltage Ratings

Part number	Value
V <sub>R</sub> Max. DC Reverse Voltage (V)	30
V <sub>RWM</sub> Max. Working Peak Reverse Voltage (V)	

## Absolute Maximum Ratings

Parameters	Value	Units	Conditions	
I <sub>F</sub> Forward Current	0.2	A	DC	
I <sub>FSM</sub> Max. Peak One Cycle Non-Repetitive Surge Current, @T <sub>J</sub> =25°C	8.4	A	5µs Sine or 3µs Rect. pulse	Following any rated load condition and with rated V <sub>RRM</sub> applied
	1.0	A	10ms Sine or 6ms Rect. pulse	

## Electrical Specifications

Parameters	Value	Units	Conditions	
V <sub>FM</sub> Max. Forward Voltage Drop (1)	0.24	V	@ 0.1mA	T <sub>J</sub> = 25°C
	0.32	V	@ 1mA	
V <sub>FM</sub> Max. Forward Voltage Drop (1)	0.40	V	@ 10mA	
	0.50	V	@ 30mA	
	0.65	V	@ 100mA	
I <sub>RM</sub> Max. Reverse Leakage Current	2	µA	V <sub>R</sub> = 25V	
	3	µA	V <sub>R</sub> = 30V	
C <sub>T</sub> Max. Junction Capacitance	10	pF	V <sub>R</sub> = 1V <sub>DC</sub> (test signal range 100KHz to 1Mhz), T <sub>J</sub> = 25°C	
dv/dt Max. Voltage Rate of Change (Rated V <sub>R</sub> )	10000	V/µs		

(1) Pulse Width < 300µs, Duty Cycle < 2%

## Thermal-Mechanical Specifications

Parameters	Value	Units	Conditions
T <sub>J</sub> Max. Junction Temperature Range(*)	-65 to 150	°C	
T <sub>stg</sub> Max. Storage Temperature Range	-65 to 150	°C	
R <sub>th(j-a)</sub> Max. Thermal Resistance Junction to Ambient	500	°C/W	Mounted on PC board FR4 with minimum pad size
Wt Approximate Weight	0.008	gr	
Case Style	SOT23		
Device Marking	IR54		

(\*)  $\frac{dP_{tot}}{dT_J} < \frac{1}{R_{th(j-a)}}$  thermal runaway condition for a diode on its own heatsink

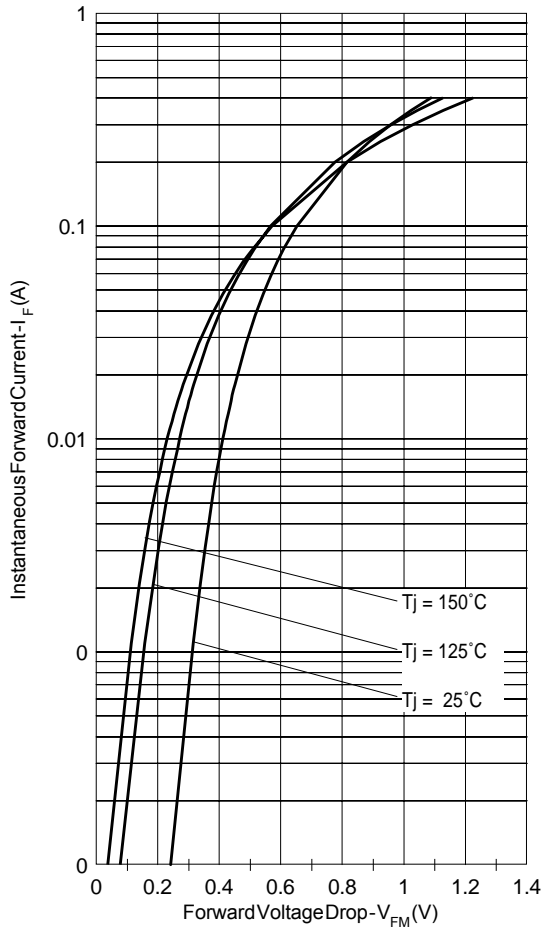

Fig. 1 - Max. Forward Voltage Drop Characteristics (Per Leg)

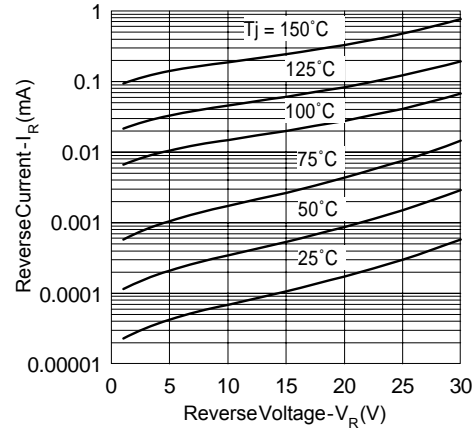

Fig. 2 - Typical Values Of Reverse Current Vs. Reverse Voltage (Per Leg)

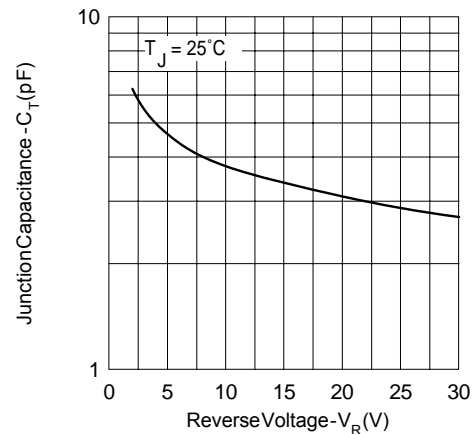

Fig. 3 - Typical Junction Capacitance Vs. Reverse Voltage (Per Leg)

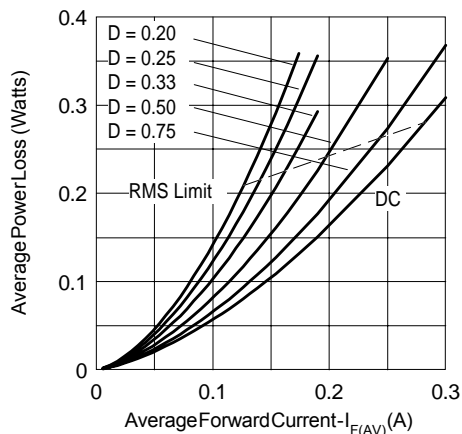

Fig. 4 - Forward Power Loss Characteristics

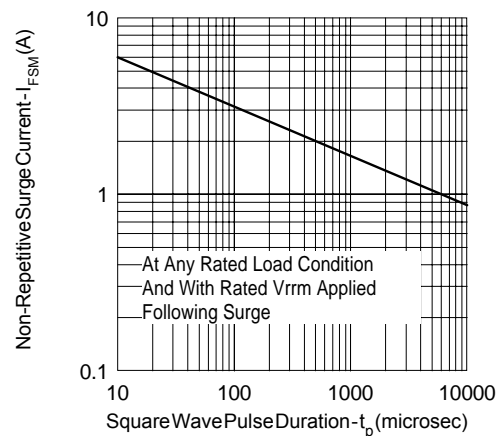
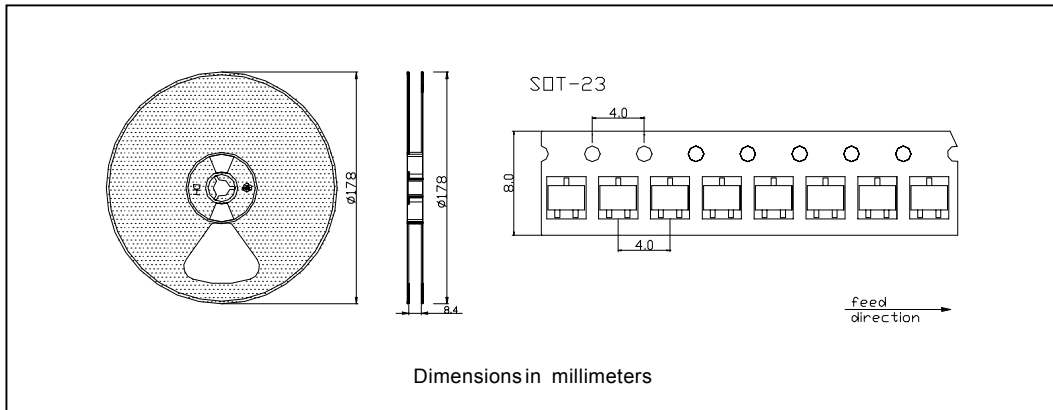

Fig. 5 - Max. Non-Repetitive Surge Current

# BAT54

Preliminary Data Sheet PD-20761 12/01

## Tape & Reel Information



## Ordering Information Table

Device	Package	Marking	Configuration	Base qty	Delivery mode
BAT54	SOT-23	IR54	Single	3000	Tape & Reel

Data and specifications subject to change without notice.  
This product has been designed for Industrial Level.  
Qualification Standards can be found on IR's Web site.