

Sup/IRBuck™

HIGHLY INTEGRATED 7A

WIDE-INPUT VOLTAGE, SYNCHRONOUS BUCK REGULATOR

Features

- Wide Input Voltage Range 2.5V to 21V
- Wide Output Voltage Range 0.6V to 12V
- Continuous 7A Load Capability
- 600kHz High Frequency Operation
- Programmable Over-Current-Protection
- Hiccup Current Limit
- Tracking capability for Memory Application
- Precision Reference Voltage (0.6V)
- Programmable Soft-Start
- Pre-Bias Start-up
- Thermal Protection
- Thermally Enhanced Package
- Small Size 5mmx6mm QFN
- Pb-Free (RoHS Compliant)

Applications

- Distributed Point-of-Loads
- Server and Workstations
- Embedded Systems
- Storage Systems
- DDR Applications
- Graphics Cards
- Game Consoles
- Computing Peripheral Voltage Regulators

Description

The IR3811 **Sup/IRBuck™** is an easy-to-use, fully integrated and highly efficient DC/DC regulator. The onboard switching controller and MOSFETs make the IR3811 a space-efficient solution, providing accurate power delivery for low output voltage applications.

The IR3811 operates from a 4.5V to 14V input supply and generates an output voltage adjustable from 0.6V to $0.80 \cdot V_{in}$ at loads up to 7A.

IR3811 can be configured for tracking applications to generate termination voltage (VTT) for memory applications.

A versatile regulator offering programmability of start up time and current limit, the IR3811's fixed 600kHz switching frequency allows the use of small external components.

IR3811 also features important protection functions, such as Pre-Bias startup, hiccup current limit and thermal shutdown to provide the required system level security in the event of fault conditions.

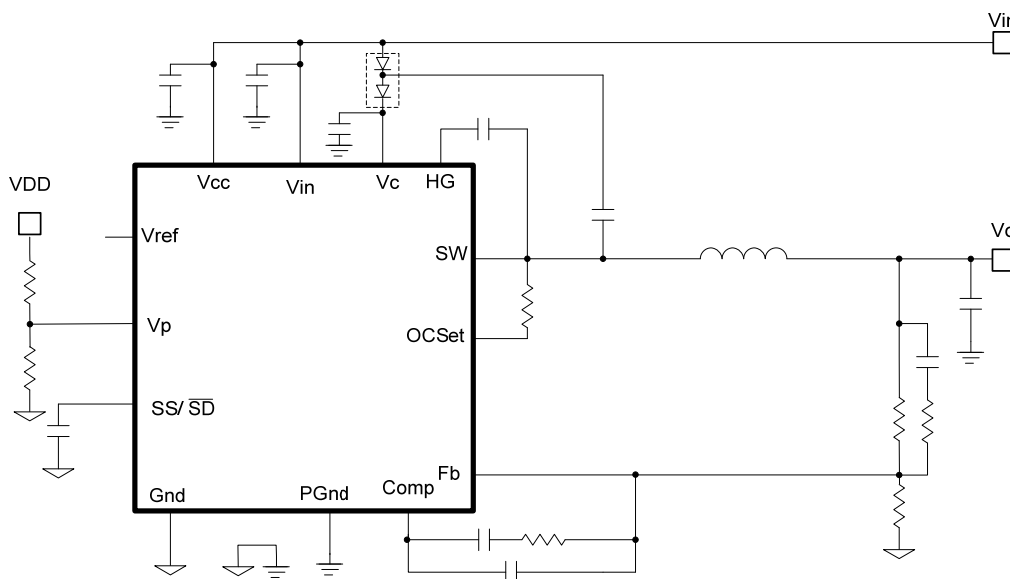

Fig. 1. Typical application diagram