

POWER MANAGEMENT

Description

The SC603 is a versatile charge pump designed for use in battery operated power supply applications. The wide input range is matched for Li-Ion battery applications. Only two tiny ceramic bucket capacitors are required, and the inductorless implementation provides a reduced-EMI solution. Low noise mode switching circuitry and constant output current allow the use of extremely small input and output capacitors.

The SC603 charge pump regulator can be used for applications that require up to 200mA of output current with a 4.5V output. The 5.0V output version provides up to 160mA of output current.

Compared to a switch mode regulator, the SC603 offers a solution with less cost, area, noise and complexity.

Features

- ◆ Small size - MLP Micro 10 lead 3x3mm package
- ◆ Selectable 5.0V or 4.5V output voltage
- ◆ 200mA available with 4.5V output
- ◆ 160mA available with 5.0V output
- ◆ Short circuit protection
- ◆ Soft Start function
- ◆ Shutdown current <math><2\mu\text{A}</math>
- ◆ Selectable fixed frequencies of 262kHz & 650kHz
- ◆ Low ripple
- ◆ Regulated to $\pm 5\%$
- ◆ Ease of use

Applications

- ◆ Cellular phones
- ◆ LED photo flash for cellular phones
- ◆ LED backlighting
- ◆ PDA power supplies
- ◆ Portable electronics
- ◆ Electronic books
- ◆ Wireless web appliances

Typical Application Circuit

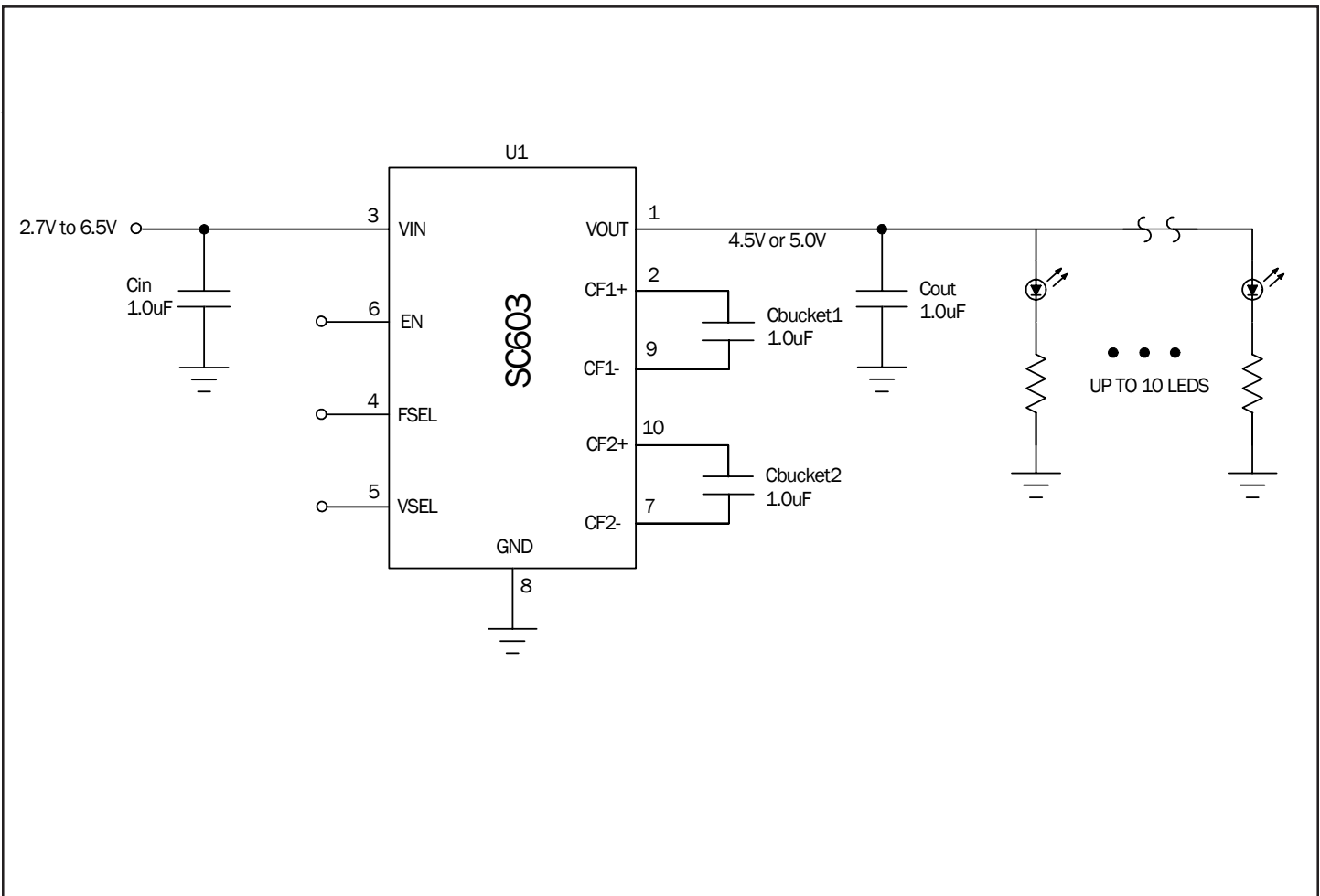

POWER MANAGEMENT
Absolute Maximum Ratings

Parameter	Symbol	Maximum	Units
Supply Voltage	V_{IN}	-0.3 to +7.0	V
Output Voltage	V_{OUT}	-0.3 to +7.0	V
V_{OUT} Short Circuit Duration	SC	Indefinite	
Thermal Resistance, Junction To Ambient (JESD51 Standard Method)	θ_{JA}	31	°C/W
Operating Ambient	T_A	-40 to +85	°C
Junction Temperature Range	T_{JC}	-40 to +150	°C
Storage Temperature Range	T_{STG}	-65 to +150	°C
Peak IR Reflow Temperature SC603IMLTR	T_{LEAD}	240	°C
Peak IR Reflow Temperature SC603IMLTRT	T_{LEAD}	260	°C

Electrical Characteristics

Unless specified: $T_A = -40^\circ\text{C}$ to 85°C , $C_{IN} = C_{BUCKET} = 1.0\mu\text{F}$ (ESR = 0.1 Ω), $C_{OUT} = 1.0\mu\text{F}$ (ESR = 0.1 Ω), $V_{IN} = 2.85\text{V}$ to 5.5V

Parameter	Symbol	Conditions	MIN	TYP	MAX	Units
Input Supply Voltage	V_{IN}		2.5		6.5	V
Quiescent Current	I_Q	Freq. = 262kHz, $I_{OUT} = 0\text{mA}$, $V_{IN} = 3.7\text{V}$		1.0	1.4	mA
		Freq. = 650kHz, $I_{OUT} = 0\text{mA}$, $V_{IN} = 3.7\text{V}$		2.1	2.8	mA
		Enable = 0			2	μA
Output Voltage	V_{OUT}	Static Load Regulation with VSEL = 1	4.75	5.0	5.25	V
		Static Load Regulation with VSEL = 0	4.275	4.5	4.725	V
Output Current	I_{OUT}	VSEL = 1, $3.2\text{V} < V_{IN} < 5.5\text{V}$			150	mA
		VSEL = 1, $3.2\text{V} < V_{IN} < 5.5\text{V}$ $T_A = -40^\circ\text{C}$ to 70°C			160	mA
		VSEL = 0, $3.2\text{V} < V_{IN} < 5.5\text{V}$			190	mA
		VSEL = 0, $3.2\text{V} < V_{IN} < 5.5\text{V}$ $T_A = -40^\circ\text{C}$ to 70°C			200	mA
		VSEL=1, $2.85\text{V} < V_{IN} < 5.5\text{V}$			60	mA
		VSEL=0, $2.85\text{V} < V_{IN} < 5.5\text{V}$			120	mA

POWER MANAGEMENT

 Unless specified: $T_A = -40^\circ\text{C to } 85^\circ\text{C}$, $C_{IN} = C_{BUCKET} = 1.0\mu\text{F}$ (ESR = 0.1 Ω), $C_{OUT} = 1.0\mu\text{F}$ (ESR = 0.1 Ω), $V_{IN} = 2.85\text{V to } 5.5\text{V}$

Parameter	Symbol	Conditions	MIN	TYP	MAX	Units
Pump Frequency	f_{PUMP}	Enable = 1, FSEL = 0	-15%	262	+15%	kHz
		Enable = 1, FSEL = 1	-20%	650	+20%	kHz
Frequency Mode Transition Time	T_{CLOCK}	Transition time from one frequency mode to any other frequency mode guaranteed by design		1		Period
Short Circuit Current	I_{SC}	$V_{OUT} = 0\text{V}$, $I_{OUT} = I_{IN}$			600	mA
Input High Threshold	V_{IH}	All input pins (Enable, VSEL, FSEL)	1.3			V
Input Low Threshold	V_{IL}	All input pins (Enable, VSEL, FSEL)			0.4	V
Input High Current	I_{IH}	All input pins (Enable, VSEL, FSEL)			10	μA
Input Low Current	I_{IL}	All input pins (Enable, VSEL, FSEL)			10	μA
Power Efficiency from Battery to Regulated Charge Pump Output	η	$V_{IN} = 3.3\text{V}$, $V_{OUT} = 5.0\text{V}$, $I_{OUT} = 60\text{mA}$ Freq.=262kHz		75.0		%
		$V_{IN} = 3.3\text{V}$, $V_{OUT} = 5.0\text{V}$, $I_{OUT} = 60\text{mA}$ Freq.=650kHz		74.5		%
Output Ripple Voltage	V_{PP}	freq = 262kHz, $I_{OUT} = 60\text{mA}$ ^{(1), (2)}		25	45	mV

- Note:
- (1) Peak to peak output ripple voltage with $C_{OUT} = C_{BUCKET} = 1\mu\text{F}$ and X5R dielectric
 - (2) Guaranteed by design
 - (3) This device is ESD sensitive. Use of standard ESD handling precautions is required.

POWER MANAGEMENT

Applications Information

Charge Pump Function for Low Ripple

The SC603 uses a voltage doubler circuit which is implemented with two switched or 'bucket' capacitors. Most charge pump doublers use only one bucket capacitor. Two bucket capacitors switching on alternate phases greatly reduce the output ripple voltage.

Over-Voltage Protection for Low Voltage Capacitors

The output is prevented from exceeding 6.0V. This feature allows the use of 6.3V ceramic capacitors.

Comparison with Other Regulation Methods

In many instances, a charge pump regulator is the best choice for portable power applications. These regulators offer many advantages over switch mode regulators. A smaller bill of materials, less layout area, lower component height, less noise, no EMF, and less overall circuit cost are typical reasons to use this type of regulation. The efficiency of a charge pump regulator often approaches and in some cases exceeds the efficiency of a switch mode regulator.

Inductors are often the largest and most expensive discrete component in a design. There are no inductors used in the SC603, so the inductor's cost and layout area are eliminated. The noise and EMF associated with the inductor are also eliminated.

The SC603's fixed frequency harmonics are an advantage in portable communications equipment, such as cellular telephones. The SC603 has distinct frequencies of operation, so the harmonics are predictable. The harmonics are not fixed in a switch mode regulator. Switch mode regulators have harmonics which vary due to the pulse width modulation used to regulate the output. Varying harmonics can be a problem because it may be more difficult to ensure acceptable noise performance over the entire operating range.

Many switch mode regulators have increased voltage ripple on the output during pulse skipping mode due to the fact that there are large periods of time when no current is supplied to the output. The SC603 supplies current to the output continuously, so the voltage ripple is less than a switch mode regulator, even with greatly reduced output capacitance.

Frequency Selection

The FSEL input is for frequency selection. A logic High level at this input will set the clock frequency to 650kHz, while a logic Low sets the clock to 262kHz. Input from a μ P or other device may be used to change the charge pump frequency at any time. The optimal frequency will depend upon the capacitor values, the load current, and the acceptable amount of output ripple.

Ripple Performance

Examples of the output ripple, charge pump frequency and capacitor size are listed in Table 2 [Ripple Performance](#).

Efficiency

Efficiency for the SC603 is defined as,

$$\eta = \frac{V_O \cdot I_O}{V_{IN} \cdot (2 \cdot I_O + I_Q)}$$

where V_O = output voltage

I_O = output current

V_{IN} = input voltage

I_Q = quiescent current [from Electrical Characteristics on page 2]

POWER MANAGEMENT
Table 2 -Ripple Performance

V_{OUT}	Freq. [kHz]	I_{OUT} [mA]	Output Ripple [mVp-p]	C_{OUT} [uF]	C_{BUCKET} [uF]
5.0V	262	100	25	1	1
	650	100	15	1	1
	262	150	50	1	1
	650	150	25	1	1
4.5V	262	100	25	1	1
	650	100	15	1	1
	262	200	60	1	1
	650	200	30	1	1

Calculating Power Dissipation

The power dissipated by the SC603 is calculated as,

$$P_D = P_{IN} - P_{OUT}$$

$$P_D = V_{IN} \cdot (2 \cdot I_O + I_Q) - V_O \cdot I_O$$

Suggested Capacitors

Table 3 is a short list of some of the manufacturers and types of multilayer ceramic capacitors that are suggested for the SC603.

Short Circuit and Over Temperature Protection

The output is current limited to 600mA to protect against short circuit conditions. Over temperature protection is also provided.

Design and Layout Considerations

The layout should be patterned after the evaluation board gerber plots shown on page 10. The center pad “thermal slug” is not internally connected to ground, but is connected to ground in the layout through a via centered on the pad and connecting to the ground plane. Pin 8 is then routed directly to the center pad. A good ground plane connection is important to make effective use of the low thermal resistance of the MLP package.

Table 3 -Suggested Capacitors

Manufacturer	Part Number	Capacitance[uF]	Dielectric Type	EIA Package Size	Voltage Rating
AVX	0805ZC105K	1.0	X7R	0805	10V
Panasonic	ECJ1VB0J105K	1.0	X5R	0402	6.3V
TDK	C1608X5R1A105	1.0	X5R	0603	10V
TDK	C1202Y5V1A106Z	1.0	X5R	0805	10V

POWER MANAGEMENT

Typical Characteristics

Efficiency vs. Input Voltage

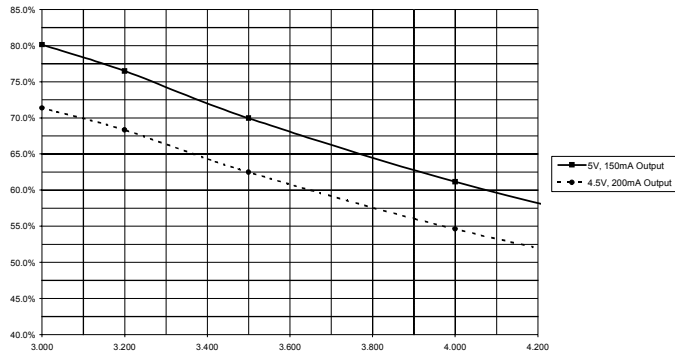

Efficiency vs. Load Current

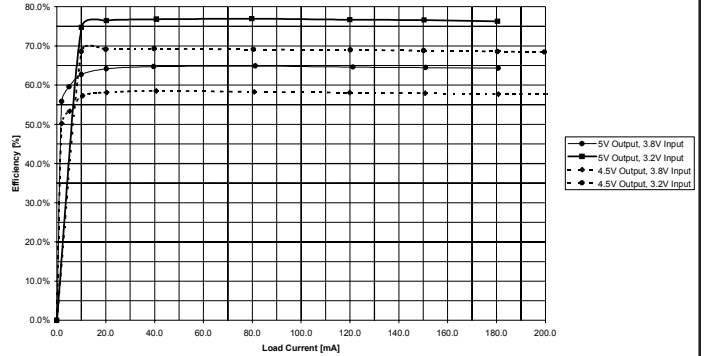

Load Regulation

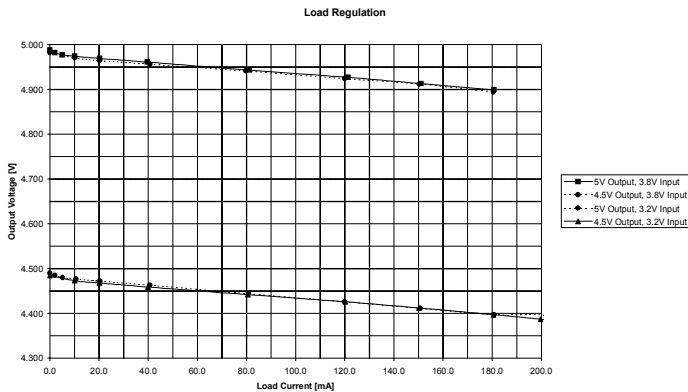

Line Regulation

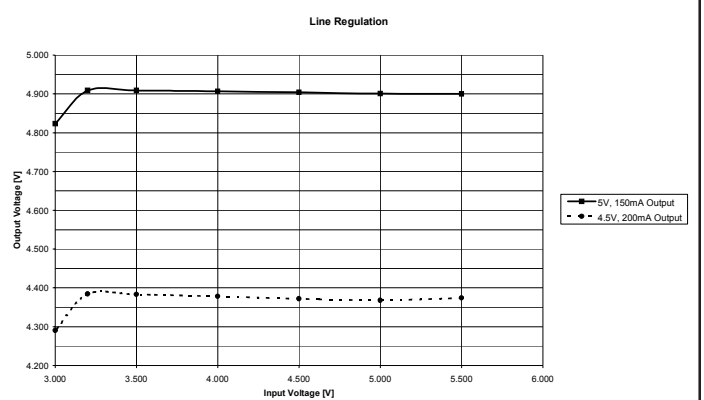

POWER MANAGEMENT

Quiescent Current

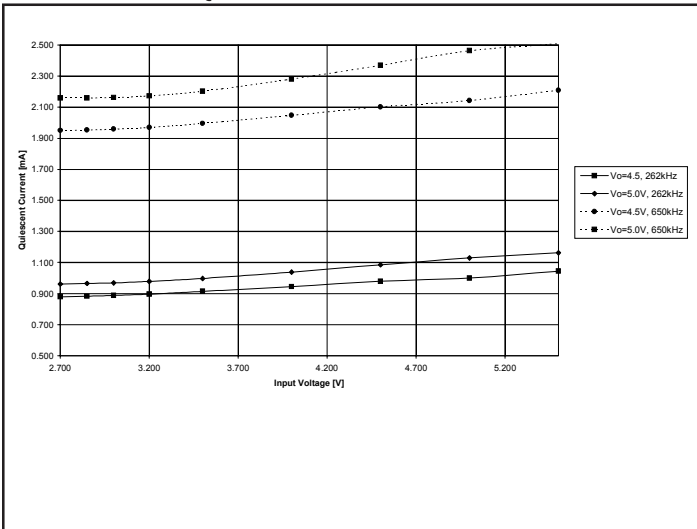

Ripple for 150mA, 5V Output

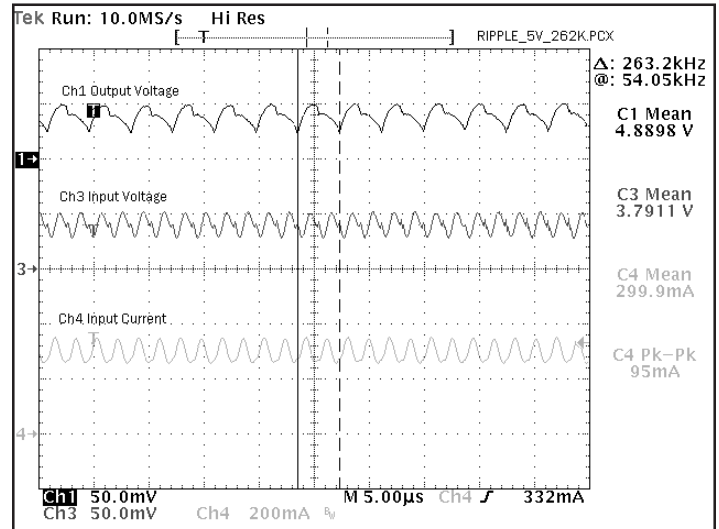

Startup Conditions for 4.5V Output

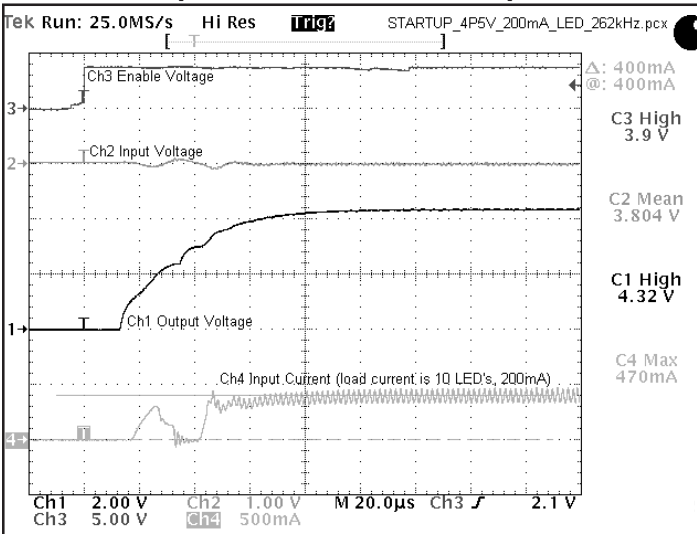

Startup Conditions for 5.0V Output

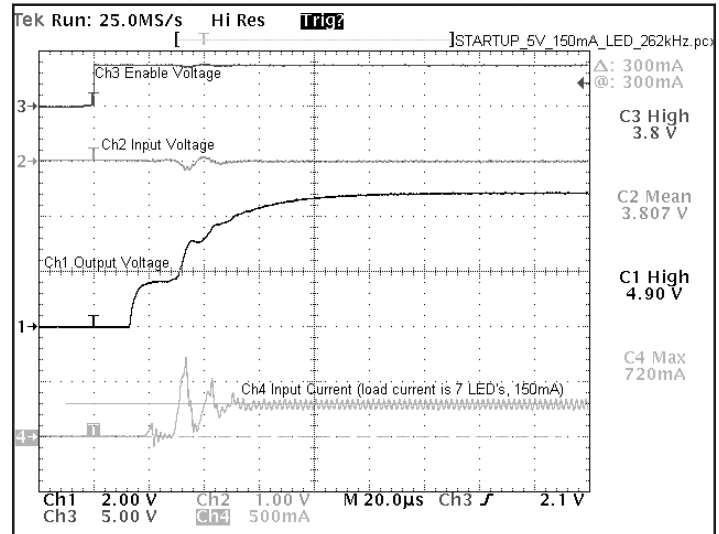

100Hz PWM for 4.5V Application

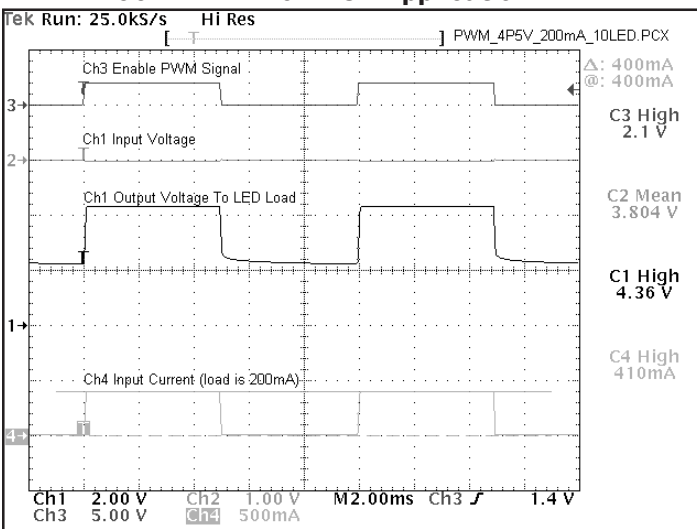

100Hz PWM for 5.0V Application

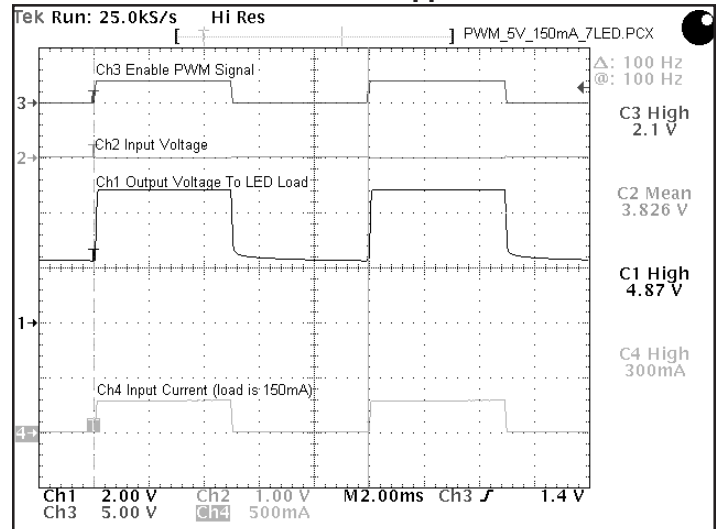

POWER MANAGEMENT

Evaluation Board Bill of Materials

Reference	Value	Comment
U1	SC603	MLP -Micro 10 lead 3x3mm.
C1, C2, C3, C4	1.0uF	Ceramic, low ESR type, voltage of 6.3V rating is acceptable for all capacitors.
C5	10uF	This extra capacitor supports usage of long power leads from a benchtop supply.
R1 through R10	-	Add limiting resistors to meet the requirements of the application on 0805 pads.
D1 through D10	-	Add white or blue LEDs to meet the requirements of the application on 1206 pads.

Evaluation Board Gerber Plots

Top View

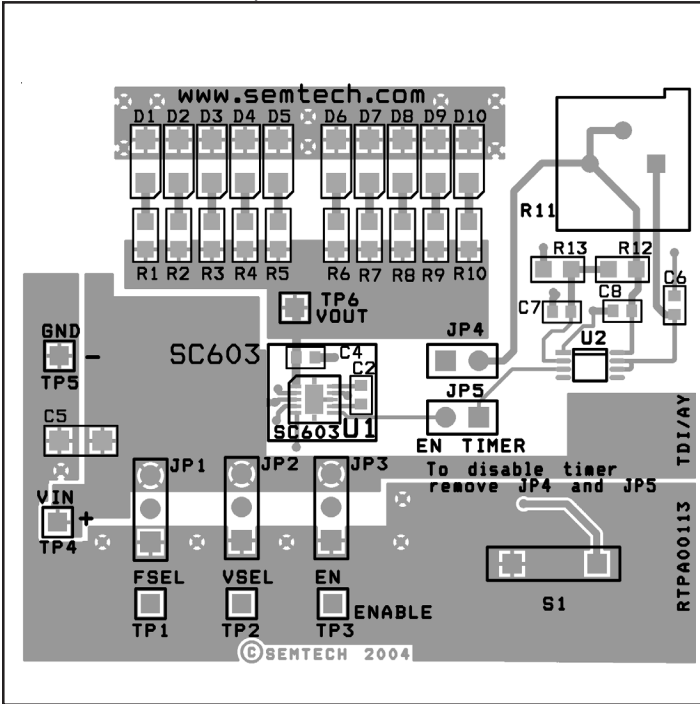

Bottom View

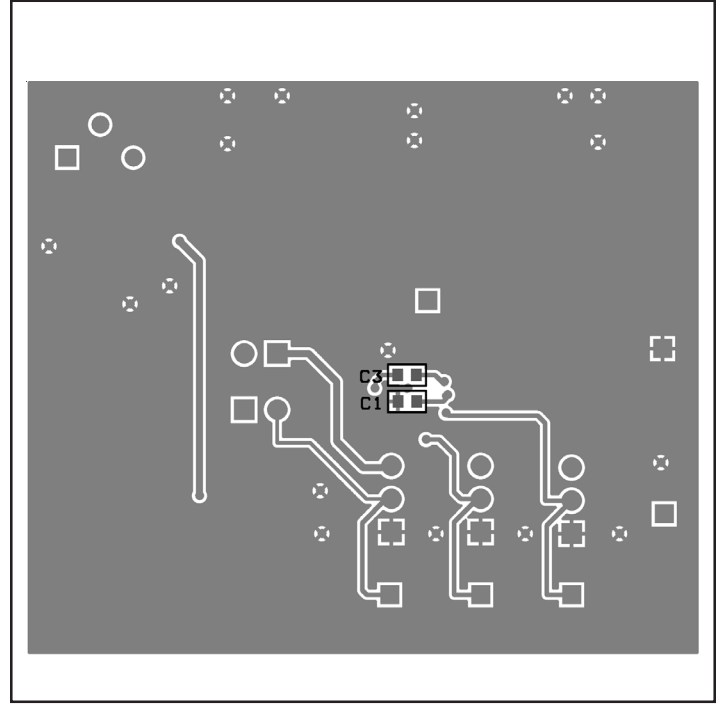

Marking Information

Top Marking

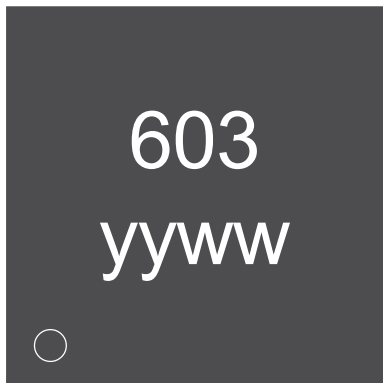

yyww = Datecode (Example: 0452)

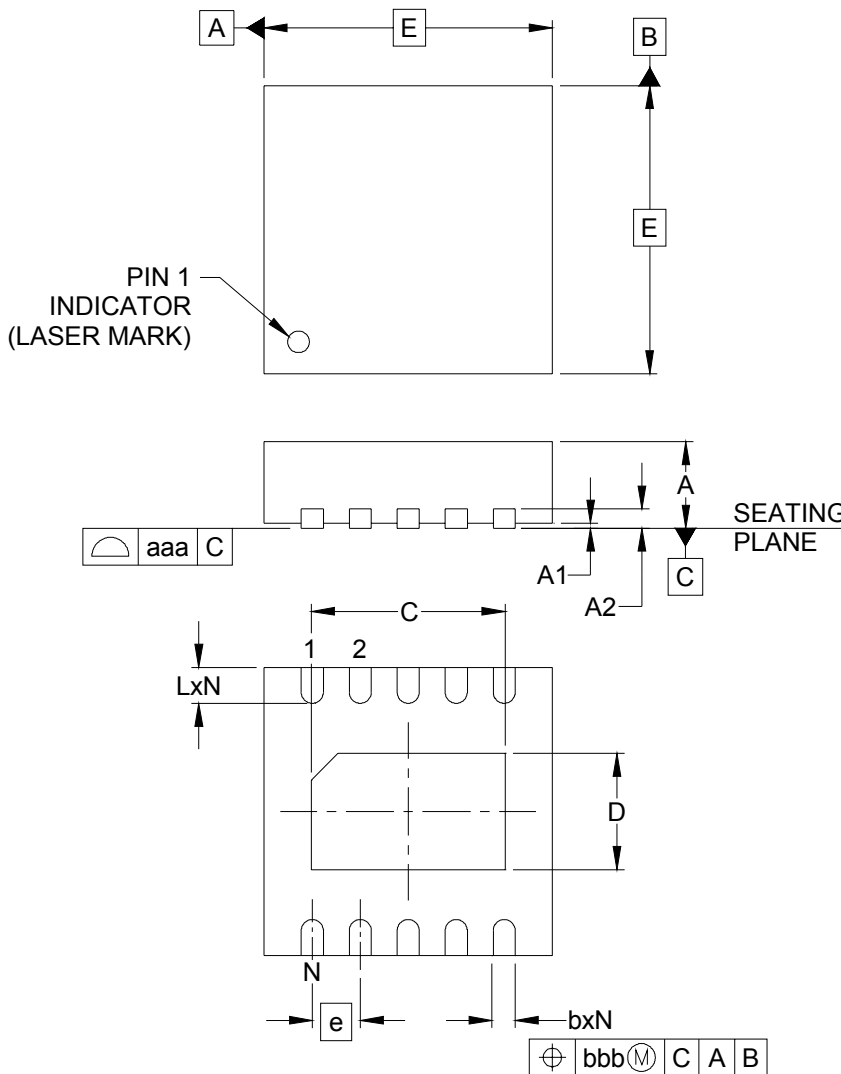
POWER MANAGEMENT
Outline Drawing - MLP-10

DIM	DIMENSIONS					
	INCHES			MILLIMETERS		
	MIN	NOM	MAX	MIN	NOM	MAX
A	.031	-	.039	0.80	-	1.00
A1	.000	-	.002	0.00	-	0.05
A2	-	(.008)	-	-	(0.20)	-
b	.007	.009	.011	0.18	0.23	0.30
C	.074	.079	.083	1.87	2.02	2.12
D	.042	.048	.052	1.06	1.21	1.31
E	.114	.118	.122	2.90	3.00	3.10
e	.020 BSC			0.50 BSC		
L	.012	.016	.020	0.30	0.40	0.50
N	10			10		
aaa	.003			0.08		
bbb	.004			0.10		

NOTES:

1. CONTROLLING DIMENSIONS ARE IN MILLIMETERS (ANGLES IN DEGREES).
2. COPLANARITY APPLIES TO THE EXPOSED PAD AS WELL AS TERMINALS.

POWER MANAGEMENT

Land Pattern - MLP-10

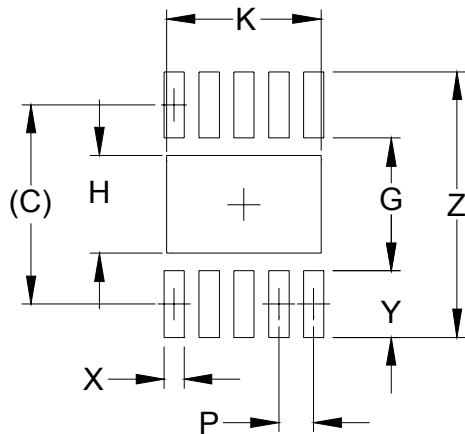

DIMENSIONS		
DIM	INCHES	MILLIMETERS
C	(.112)	(2.85)
G	.075	1.90
H	.055	1.40
K	.087	2.20
P	.020	0.50
X	.012	0.30
Y	.037	0.95
Z	.150	3.80

NOTES:

1. THIS LAND PATTERN IS FOR REFERENCE PURPOSES ONLY. CONSULT YOUR MANUFACTURING GROUP TO ENSURE YOUR COMPANY'S MANUFACTURING GUIDELINES ARE MET.

Contact Information

Semtech Corporation
 Power Management Products Division
 200 Flynn Road, Camarillo, CA 93012
 Phone: (805)498-2111 FAX (805)498-3804