

# SKiiP 11NAB126V1

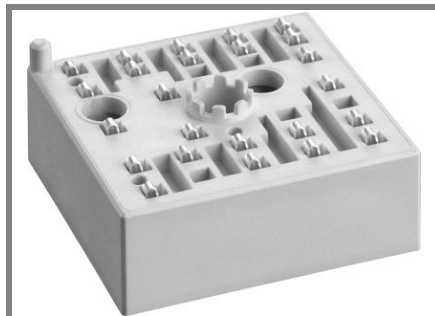

MiniSKiiP<sup>®</sup> 1

3-phase bridge rectifier +  
brake chopper + 3-phase  
bridge inverter  
SKiiP 11NAB126V1

## Features

- Fast Trench IGBTs
- Robust and soft freewheeling diodes in CAL technology
- Highly reliable spring contacts for electrical connections
- UL recognised file no. E63532

## Typical Applications

- Inverter up to 8 kVA
- Typical motor power 4 kW

## Remarks

- $V_{CEsat}$ ,  $V_F$  = chip level value

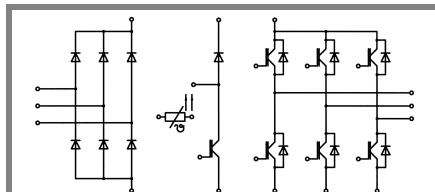

NAB

Absolute Maximum Ratings		$T_s = 25\text{ °C}$ , unless otherwise specified	
Symbol	Conditions	Values	Units
<b>IGBT - Inverter, Chopper</b>			
$V_{CES}$	$T_s = 25\text{ (70) °C}$ $t_p \leq 1\text{ ms}$	1200	V
$I_C$		16 (15)	A
$I_{CRM}$		16	A
$V_{GES}$		$\pm 20$	V
$T_j$		- 40 ... + 150	°C
<b>Diode - Inverter, Chopper</b>			
$I_F$	$T_s = 25\text{ (70) °C}$ $t_p \leq 1\text{ ms}$	14 (11)	A
$I_{FRM}$		16	A
$T_j$		- 40 ... + 150	°C
<b>Diode - Rectifier</b>			
$V_{RRM}$	$T_s = 70\text{ °C}$ $t_p = 10\text{ ms, sin } 180\text{ °, } T_j = 25\text{ °C}$ $t_p = 10\text{ ms, sin } 180\text{ °, } T_j = 25\text{ °C}$	1600	V
$I_F$		35	A
$I_{FSM}$		220	A
$i^2t$		240	A <sup>2</sup> s
$T_j$		- 40 ... + 150	°C
$I_{tRMS}$	per power terminal (20 A / spring)	20	A
$T_{stg}$	$T_{op} \leq T_{stg}$	- 40 ... + 125	°C
$V_{isol}$	AC, 1 min.	2500	V

Characteristics		$T_s = 25\text{ °C}$ , unless otherwise specified			
Symbol	Conditions	min.	typ.	max.	Units
<b>IGBT - Inverter, Chopper</b>					
$V_{CEsat}$	$I_{Cnom} = 8\text{ A, } T_j = 25\text{ (125) °C}$		1,7 (2)	2,1 (2,4)	V
$V_{GE(th)}$	$V_{GE} = V_{CE}, I_C = 0,3\text{ mA}$	5	5,8	6,5	V
$V_{CE(TO)}$	$T_j = 25\text{ (125) °C}$		1 (0,9)	1,2 (1,1)	V
$r_T$	$T_j = 25\text{ (125) °C}$		87 (138)	113 (162)	mΩ
$C_{ies}$	$V_{CE} = 25\text{ V, } V_{GE} = 0\text{ V, } f = 1\text{ MHz}$		0,7		nF
$C_{oes}$	$V_{CE} = 25\text{ V, } V_{GE} = 0\text{ V, } f = 1\text{ MHz}$		0,1		nF
$C_{res}$	$V_{CE} = 25\text{ V, } V_{GE} = 0\text{ V, } f = 1\text{ MHz}$		0,1		nF
$R_{th(j-s)}$	per IGBT		1,5		K/W
$t_{d(on)}$	under following conditions		35		ns
$t_r$	$V_{CC} = 600\text{ V, } V_{GE} = \pm 15\text{ V}$		25		ns
$t_{d(off)}$	$I_{Cnom} = 8\text{ A, } T_j = 125\text{ °C}$		365		ns
$t_f$	$R_{Gon} = R_{Goff} = 50\text{ Ω}$		105		ns
$E_{on}$	inductive load		0,8		mJ
$E_{off}$			1		mJ
<b>Diode - Inverter, Chopper</b>					
$V_F = V_{EC}$	$I_{Fnom} = 8\text{ A, } T_j = 25\text{ (125) °C}$		1,9 (2)	2,2 (2,4)	V
$V_{(TO)}$	$T_j = 25\text{ (125) °C}$		1 (0,8)	1,1 (0,9)	V
$r_T$	$T_j = 25\text{ (125) °C}$		112 (150)	138 (187)	mΩ
$R_{th(j-s)}$	per diode		2,5		K/W
$I_{RRM}$	under following conditions		12		A
$Q_{rr}$	$I_{Fnom} = 8\text{ A, } V_R = 600\text{ V}$		1,8		μC
$E_{rr}$	$V_{GE} = 0\text{ V, } T_j = 125\text{ °C}$		0,9		mJ
	$di_F/dt = 520\text{ A/μs}$				
<b>Diode - Rectifier</b>					
$V_F$	$I_{Fnom} = 15\text{ A, } T_j = 25\text{ °C}$		1,1		V
$V_{(TO)}$	$T_j = 150\text{ °C}$		0,8		V
$r_T$	$T_j = 150\text{ °C}$		20		mΩ
$R_{th(j-s)}$	per diode		1,5		K/W
<b>Temperature Sensor</b>					
$R_{ts}$	3 %, $T_r = 25\text{ (100) °C}$		1000(1670)		Ω
<b>Mechanical Data</b>					
w			35		g
$M_s$	Mounting torque	2		2,5	Nm

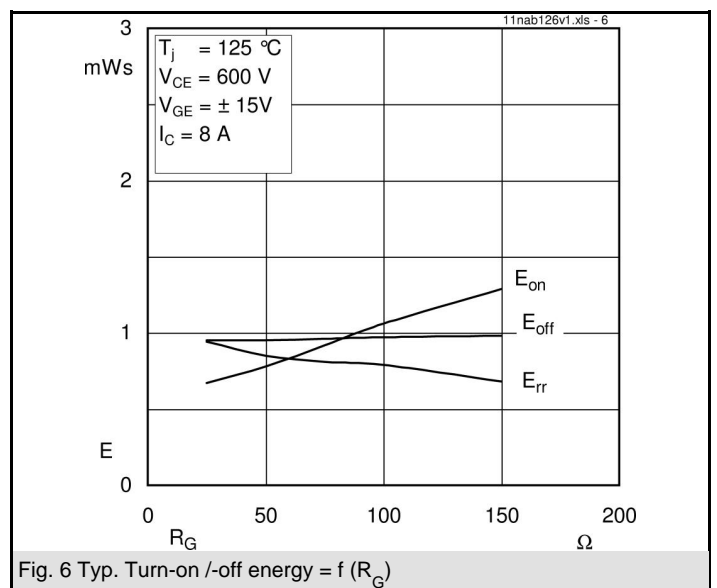
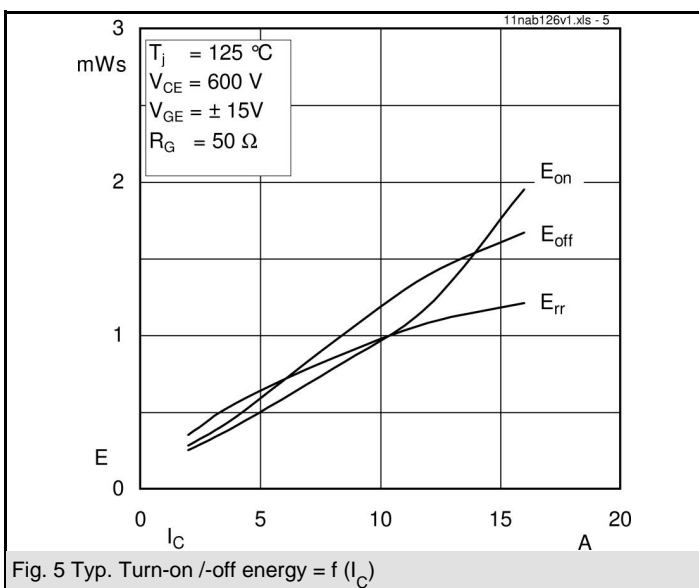
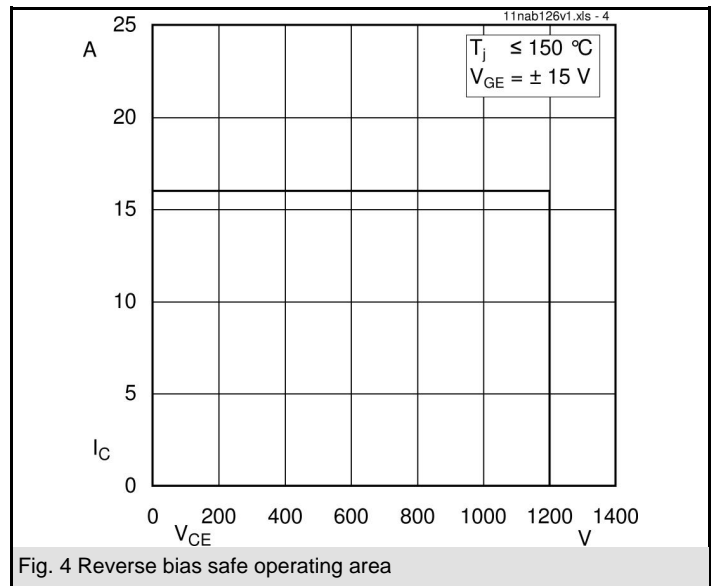
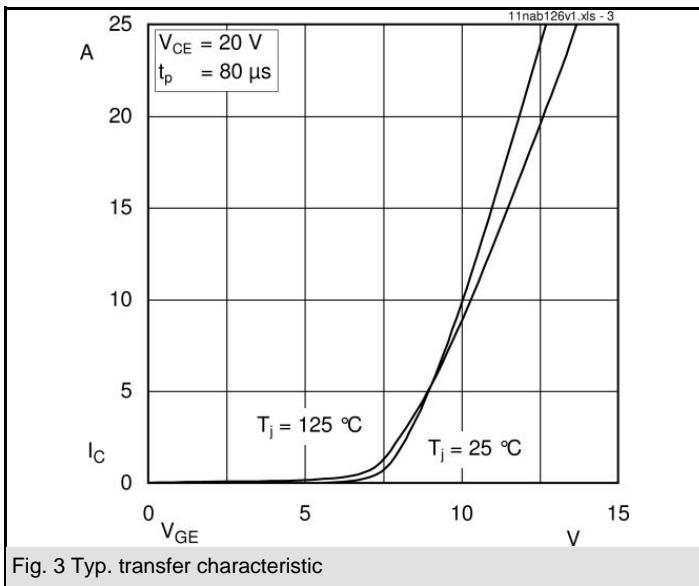
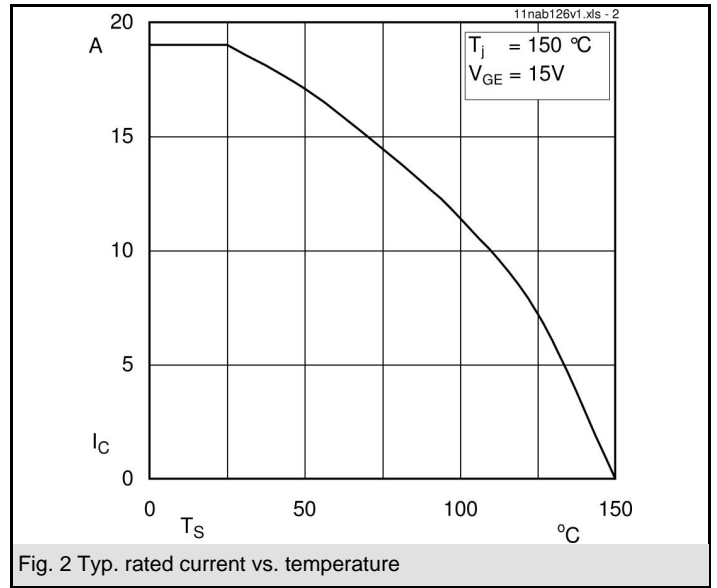
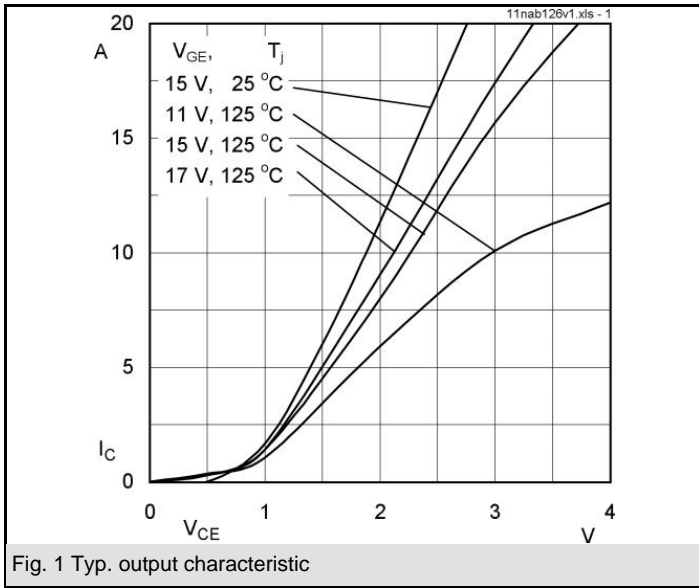

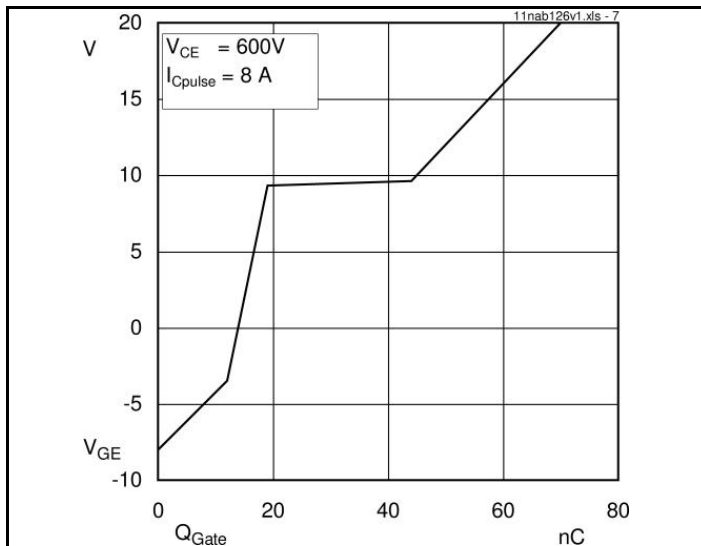

Fig. 7 Typ. gate charge characteristic

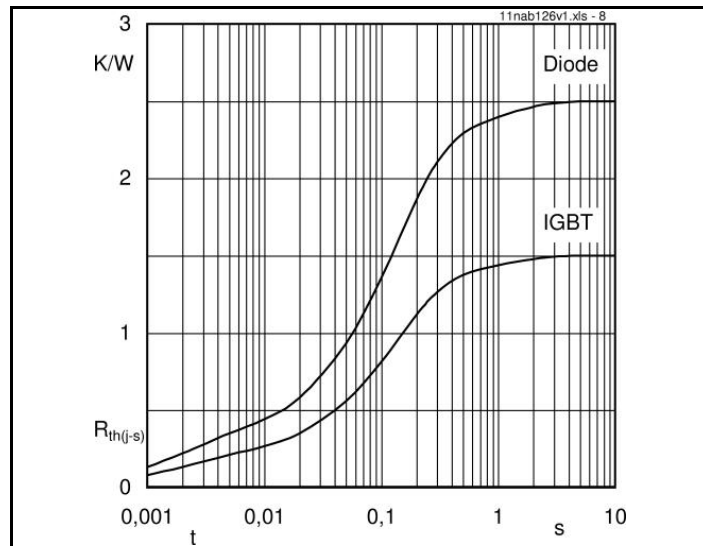

Fig. 8 Typ. thermal impedance

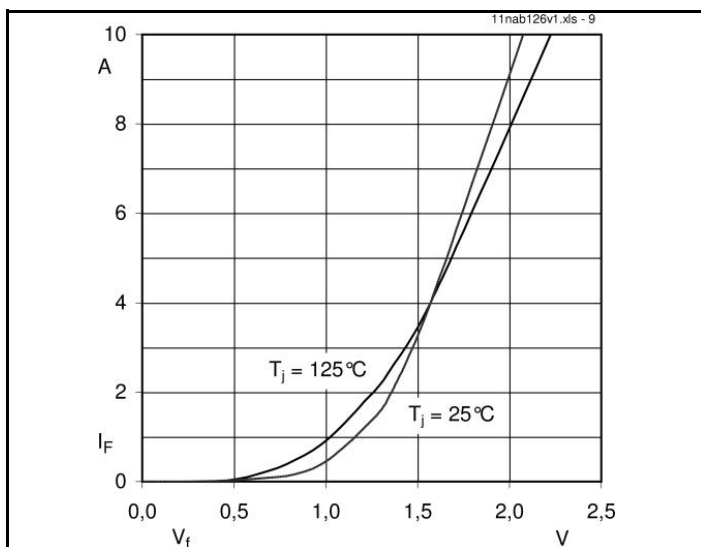

Fig. 9 Typ. freewheeling diode forward characteristic

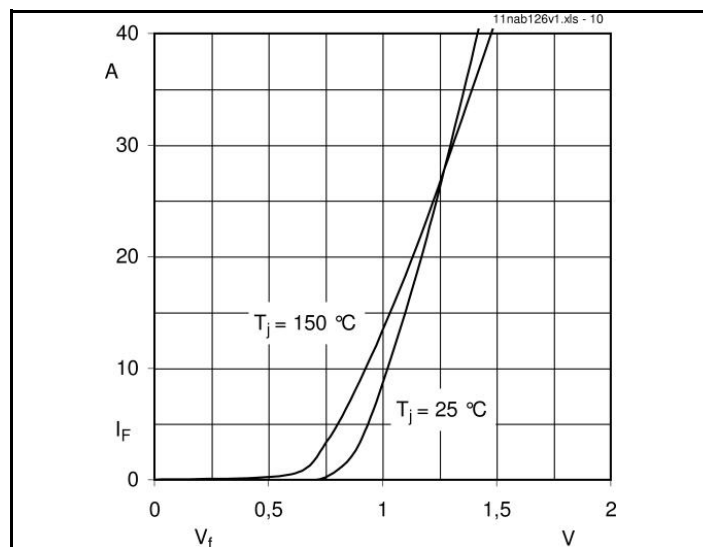
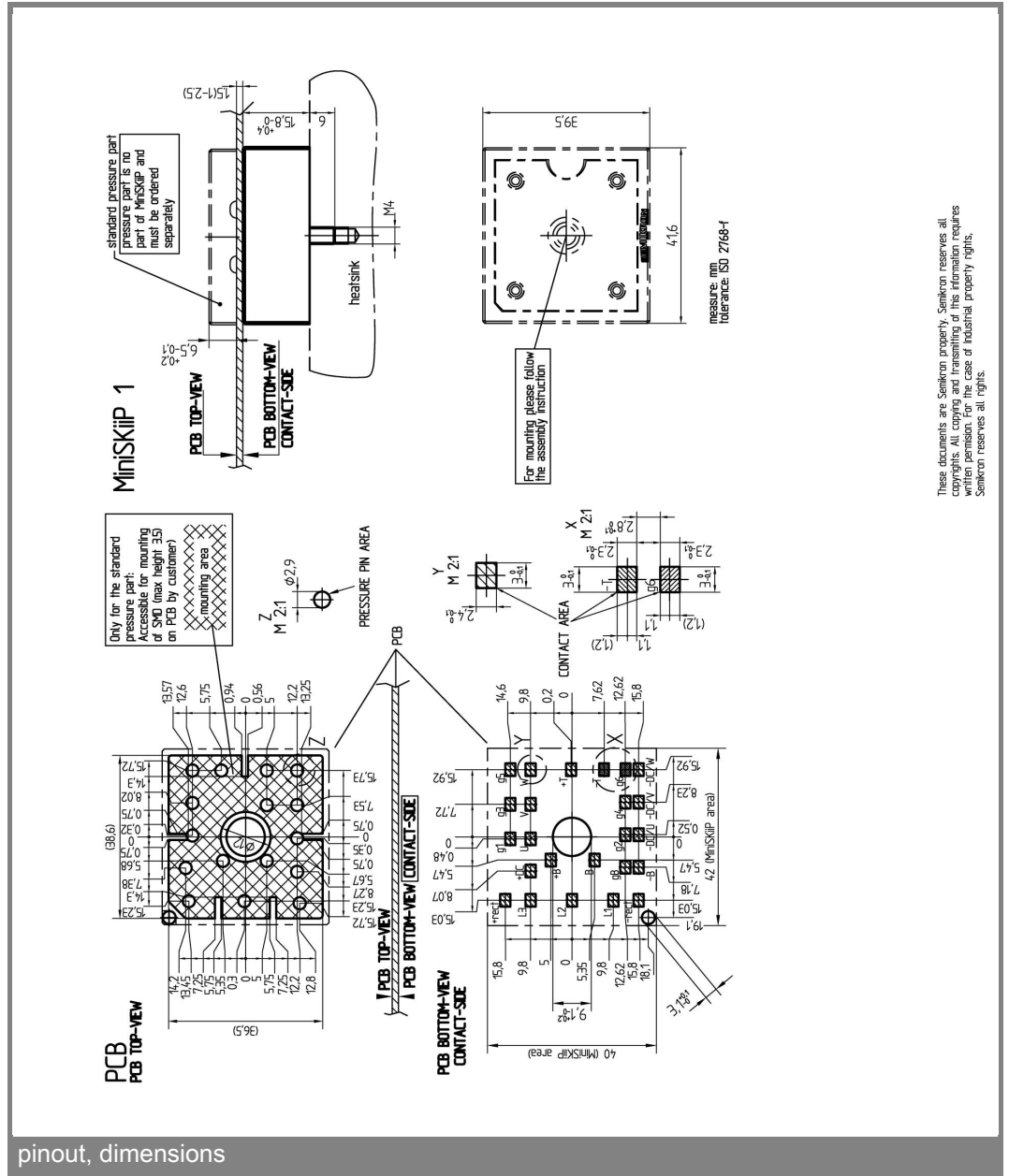
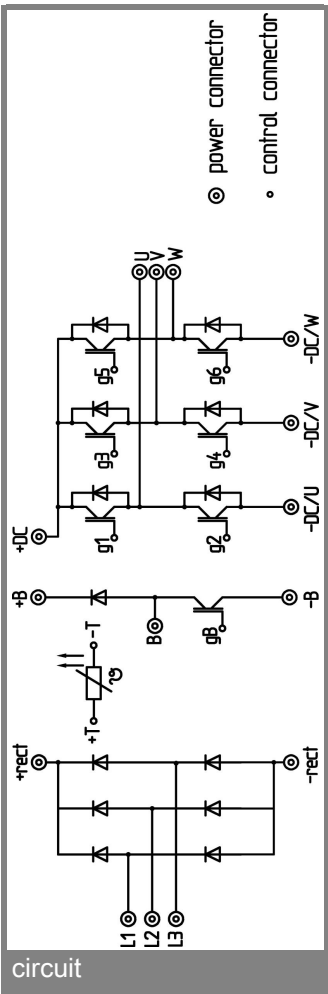

Fig. 10 Typ. input bridge forward characteristic



These documents are Semikron property. Semikron reserves all copyright and other intellectual property rights. Any reproduction without written permission for the case of industrial property rights. Semikron reserves all rights.