

Spread Spectrum Timing Solution for Serverworks Chipset

Features

- Maximized EMI suppression using Cypress's spread spectrum technology
- Based on Industry Standard CK133 Pinout with all outputs compliant to CK98 specifications
- 0.5% downspread outputs deliver up to 10dB lower EMI
- 6 skew-controlled copies of CPU output
- 6 copies of PCI output (synchronous w/CPU output)
- 2 copies of 66 MHz fixed frequency 3.3V clock
- 3 copies of 16.67 MHz IOAPIC clock, synchronous to CPU clock
- 1 copy of 48 MHz USB output
- 2 copies of 14.31818 MHz reference clock
- Programmable to 133 or 100 MHz operation
- Power management control pins for clock stop and shut down
- Available in 56-pin SSOP

Key Specifications

Supply Voltages: $V_{DD33} = 3.3V \pm 5\%$
 $V_{DD25} = 2.5V \pm 5\%$
 CPU Output Jitter: <150 ps
 CPU Output Skew:..... <175 ps
 CPU to 3V66 Output Offset: 0.0 to 1.5 ns (CPU leads)
 CPU to IOAPIC Output Offset 1.5 to 4.0 ns (CPU leads)
 CPU to PCI Output Offset..... 0 to 4.0 ns (CPU leads)

Table 1. Pin Selectable Frequency

SEL133/100#	CPU0:5 (MHz)	PCI
1	133	33.3
0	100	33.3

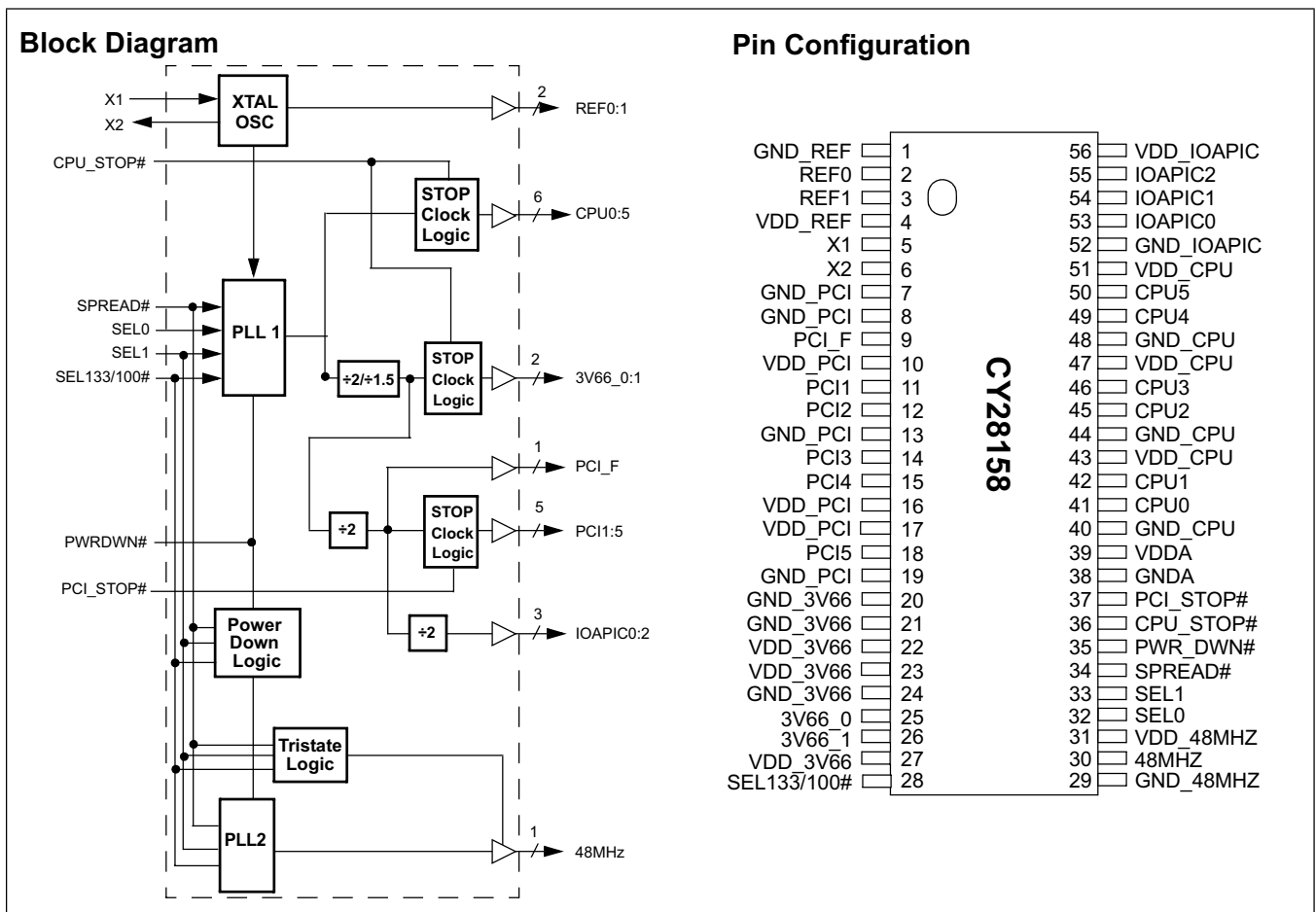

Pin Definitions

Name	Pins	Description
X1 ^[1]	5	Reference crystal input
X2 ^[1]	6	Reference crystal feedback
CPU [0–5]	41, 42, 45, 46, 49, 50	CPU clock outputs
PCI [1–5]	11, 12, 14, 15, 18	PCI clock outputs, synchronously running at 33.33 MHz
PCI_F	9	Free running PCI clock
3V66 [0–1]	25, 26	3V66 clock outputs, running at 66.66 MHz
IOAPIC [0–2]	53, 54, 55	IOAPIC clock outputs, running at 16.67 MHz
REF [0–1]	2, 3	Reference clock outputs, 14.318 MHz
48MHZ	30	48-MHz USB clock output
CPU_STOP#	36	Active LOW input, disables CPU and 3V66 clocks when asserted
PCI_STOP#	37	Active LOW input, disables PCI clocks when asserted
PWR_DWN#	35	Active LOW input, powers down part when asserted
SPREAD#	34	Active LOW input, enables spread spectrum when asserted
SEL1	33	CPU frequency select input (See Function Table)
SEL0	32	CPU frequency select input (See Function Table)
SEL133/100#	28	CPU frequency select input (See Function Table)
GND_REF	1	3.3V Reference ground
GND_PCI	7, 8, 13, 19	3.3V PCI ground
GND_3V66	20, 21, 24	3.3V 66-MHz (AGP) ground
GND_48MHZ	29	3.3V 48-MHz (USB) ground
GND_IOAPIC	52	2.5V APIC ground
GND_CPU	40, 44, 48	2.5V CPU ground
GND_A	38	Analog ground to PLL and Core
VDD_REF	4	3.3V Reference voltage supply
VDD_PCI	10, 16, 17	3.3V PCI voltage supply
VDD_3V66	22, 23, 27	3.3V 66-MHz (AGP) voltage supply
VDD_48MHZ	31	3.3V 48-MHz (USB) voltage supply
VDD_IOAPIC	56	2.5V APIC voltage supply
VDD_CPU	43, 47, 51	2.5V CPU voltage supply
VDDA	39	Analog voltage supply to PLL and Core

Note:

1. For best accuracy, use a parallel-resonant crystal, $C_{LOAD} = 18$ pF. For crystals with different C_{LOAD} , please refer to the application note, "Crystal Oscillator Topics."

Function Table^[2]

SEL133/ 100#	SEL1	SEL0	CPU (MHz)	3V66 (MHz)	PCI (MHz)	48MHZ (MHz)	REF (MHz)	IOAPIC (MHz)
0	0	0	Hi-Z	Hi-Z	Hi-Z	Hi-Z	Hi-Z	Hi-Z
0	0	1	100.227 ^[3]	66.818 ^[3]	33.409 ^[3]	48.008 ^[3]	14.318 ^[3]	16.705 ^[3]
0	1	0	100	66.67	33.33	OFF	14.318	16.67
0	1	1	100	66.67	33.33	48.008 ^[3]	14.318	16.67
1	0	0	TCLK/2	TCLK/4	TCLK/8	TCLK/2	TCLK	TCLK/16
1	0	1	N/A	N/A	N/A	N/A	N/A	N/A
1	1	0	133.33	66.67	33.33	OFF	14.318	16.67
1	1	1	133.33	66.67	33.33	48.008 ^[3]	14.318	16.67

Actual Clock Frequency Values

Clock Output	Target Frequency (MHz)	Actual Frequency (MHz)	PPM
CPU	100.0	99.126	-8740
CPU	133.33	132.769	-4208
48MHZ	48.0	48.008	167

Clock Enable Configuration

CPU_STOP#	PWR_DWN#	PCI_STOP#	CPU	3V66	PCI	PCI_F	REF IOAPIC	OSC.	VCOs
X	0	X	LOW	LOW	LOW	LOW	LOW	OFF	OFF
0	1	0	LOW	LOW	LOW	ON	ON	ON	ON
0	1	1	LOW	LOW	ON	ON	ON	ON	ON
1	1	0	ON	ON	LOW	ON	ON	ON	ON
1	1	1	ON	ON	ON	ON	ON	ON	ON

Clock Driver Impedances

Buffer Name	V _{DD} Range	Buffer Type	Impedance		
			Minimum Ω	Typical Ω	Maximum Ω
CPU, IOAPIC	2.375V – 2.625V	Type 1	13.5	29	45
48MHZ, REF	3.135V – 3.465V	Type 3	20	40	60
PCI, 3V66	3.135V – 3.465V	Type 5	12	30	55

Note:

2. TCLK is a test clock driven in on the X1 input in test mode.
3. This selection is defined as "N/A" or "Reserved."

Maximum Ratings

(Above which the useful life may be impaired. For user guidelines, not tested.)

Supply Voltage.....-0.5 to +7.0V

Input Voltage.....-0.5V to $V_{DD}+0.5$

Storage Temperature (Non-Condensing)-65°C to +150°C

Max. Soldering Temperature (10 sec)..... +260°C

Junction Temperature..... +150°C

Package Power Dissipation..... 1W

Static Discharge Voltage
(per MIL-STD-883, Method 3015) >2000V

Operating Conditions^[4] Over which Electrical Parameters are Guaranteed

Parameter	Description	Min.	Max.	Unit
V_{DD_REF} , V_{DD_PCI} , V_{DDA} , V_{DD_3V66} , V_{DD_48MHZ}	3.3V Supply Voltages	3.135	3.465	V
V_{DD_CPU}	CPU Supply Voltage	2.375	2.625	V
V_{DD_IOAPIC}	IOAPIC Supply Voltage	2.375	2.625	V
T_A	Operating Temperature, Ambient	0	70	°C
C_L	Max. Capacitive Load on CPU, 48MHZ, REF, IOAPIC PCI, 3V66		20 30	pF
$f_{(REF)}$	Reference Frequency, Oscillator Nominal Value	14.318	14.318	MHz

Electrical Characteristics Over the Operating Range

Parameter	Description	Test Conditions	Min.	Max.	Unit
V_{IH}	High-level Input Voltage	Except Crystal Pads. Threshold voltage for crystal pads = $V_{DD}/2$	2.0		V
V_{IL}	Low-level Input Voltage	Except Crystal Pads		0.8	V
V_{OH}	High-level Output Voltage	CPU, IOAPIC $I_{OH} = -1$ mA	2.0		V
		48 MHz, REF, PCI, 3V66 $I_{OH} = -1$ mA	2.4		
V_{OL}	Low-level Output Voltage	CPU, IOAPIC $I_{OL} = 1$ mA		0.4	V
		48 MHz, REF, PCI, 3V66 $I_{OL} = 1$ mA		0.4	
I_{IH}	Input High Current	$0 \leq V_{IN} \leq V_{DD}$		10	μ A
I_{IL}	Input Low Current	$0 \leq V_{IN} \leq V_{DD}$		10	μ A
I_{OH}	High-level Output Current	CPU $V_{OH} = 2.0V$	-16		mA
		IOAPIC $V_{OH} = 2.0V$	-20		
		48 MHz, REF $V_{OH} = 2.4V$	-15		
		3V66, PCI $V_{OH} = 2.4V$	-30		
			-100		
I_{OL}	Low-level Output Current	CPU $V_{OL} = 0.4V$	19		mA
		IOAPIC $V_{OL} = 0.4V$	25		
		48 MHz, REF $V_{OL} = 0.4V$	10		
		3V66, PCI $V_{OL} = 0.4V$	20		
			49		
I_{OZ}	Output Leakage Current	Three-state		10	μ A
I_{DD2}	2.5V Power Supply Current	$V_{DDA}/V_{DD33} = 3.465V$, $V_{DD25} = 2.625V$, $F_{CPU} = 133$ MHz		90	mA

Electrical Characteristics Over the Operating Range (continued)

Parameter	Description	Test Conditions	Min.	Max.	Unit
I _{DD3}	3.3V Power Supply Current	V _{DDA} /V _{DD33} = 3.465V, V _{DD25} = 2.625V, F _{CPU} = 133 MHz		160	mA
I _{DDPD2}	2.5V Shutdown Current	V _{DDA} /V _{DD33} = 3.465V, V _{DD25} = 2.625V		100	μA
I _{DDPD3}	3.3V Shutdown Current	V _{DDA} /V _{DD33} = 3.465V, V _{DD25} = 2.625V		200	μA

Switching Characteristics^[5] Over the Operating Range

Parameter	Output	Description	Test Conditions	Min.	Max.	Unit
t ₁	All	Output Duty Cycle ^[6]	t _{1A} /t _{1B}	45	55	%
t ₂	CPU, IOAPIC	Rising Edge Rate	Between 0.4V and 2.0V	1.0	4.0	V/ns
t ₂	48MHZ, REF	Rising Edge Rate	Between 0.4V and 2.4V	0.5	2.0	V/ns
t ₂	PCI, 3V66	Rising Edge Rate	Between 0.4V and 2.4V	1.0	4.0	V/ns
t ₃	CPU, IOAPIC	Falling Edge Rate	Between 2.0V and 0.4V	1.0	4.0	V/ns
t ₃	48MHZ, REF	Falling Edge Rate	Between 2.4V and 0.4V	0.5	2.0	V/ns
t ₃	PCI, 3V66	Falling Edge Rate	Between 2.4V and 0.4V	1.0	4.0	V/ns
t ₆	CPU	CPU-CPU Skew	Measured at 1.25V		175	ps
t ₈	IOAPIC	IOAPIC-IOAPIC Skew	Measured at 1.25V		250	ps
t ₉	3V66	3V66-3V66 Skew	Measured at 1.5V		250	ps
t ₁₀	PCI	PCI-PCI Skew	Measured at 1.5V		500	ps
t ₁₁	CPU, 3V66	CPU-3V66 Clock Skew	CPU leads. Measured at 1.25V for 2.5V clocks and 1.5V for 3.3V clocks	0	1.5	ns
t ₁₂	3V66, PCI	3V66-PCI Clock Skew	3V66 leads. Measured at 1.5V	0.5	2.5	ns
t ₁₃	CPU, IOAPIC	CPU-IOAPIC Clock Skew	CPU leads. Measured at 1.25V	1.5	4	ns
	CPU	Cycle-Cycle Clock Jitter	With all outputs running		150	ps
	IOAPIC	Cycle-Cycle Clock Jitter			500	ps
	48MHZ	Cycle-Cycle Clock Jitter			500	ps
	3V66	Cycle-Cycle Clock Jitter			500	ps
	REF	Cycle-Cycle Clock Jitter			1000	ps
	CPU, PCI	Settle Time	CPU and PCI clock stabilization from power-up		3	ms

Notes:

4. Multiple Supplies: The voltage on any input or I/O pin cannot exceed the power pin during power-up. Power supply sequencing is NOT required.
5. All parameters specified with loaded outputs.
6. Duty cycle is measured at 1.5V when V_{DD} = 3.3V. When V_{DD} = 2.5V, duty cycle is measured at 1.25V.

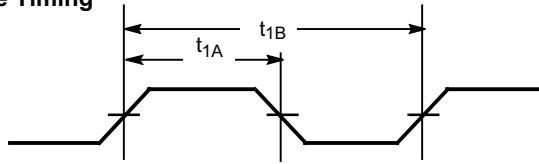
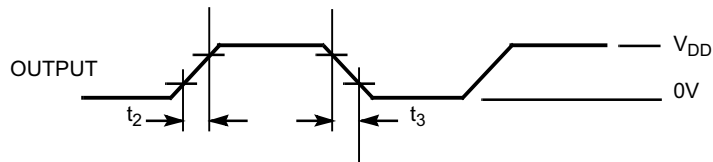
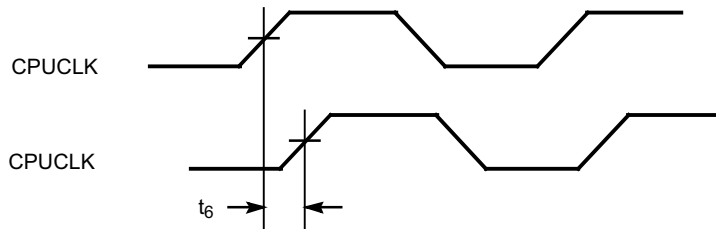
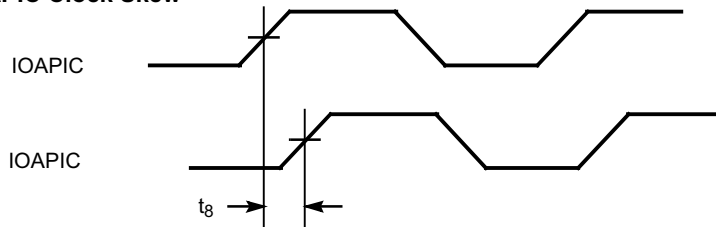
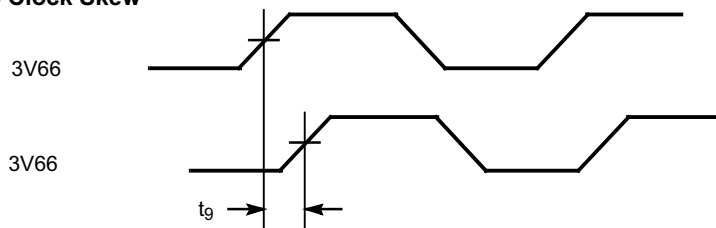
Switching Waveforms
Duty Cycle Timing

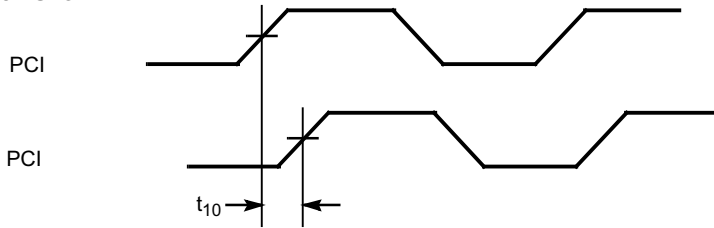
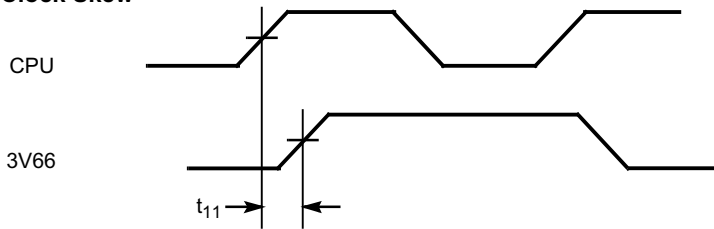
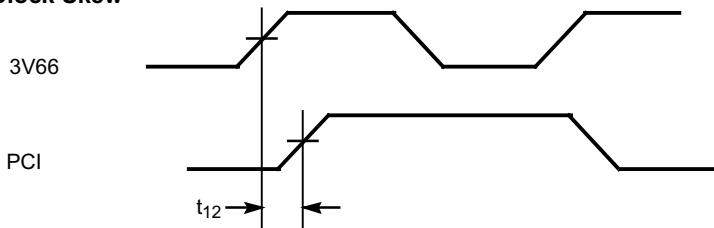
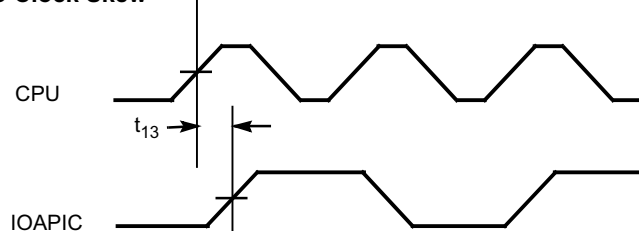
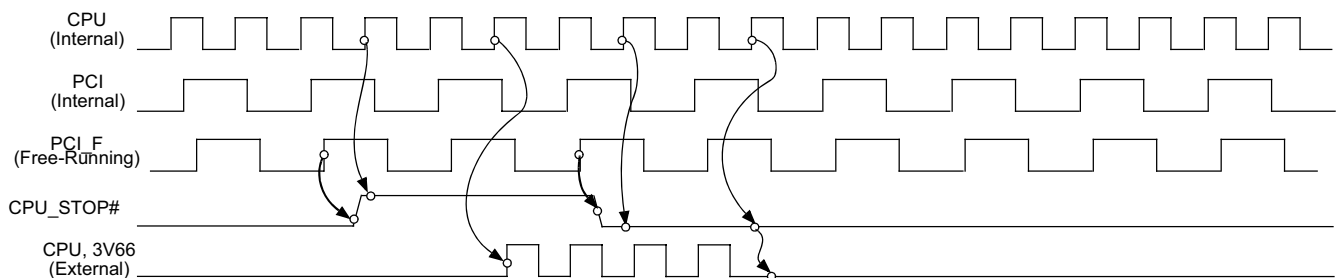
All Outputs Rise/Fall Time

CPU-CPU Clock Skew

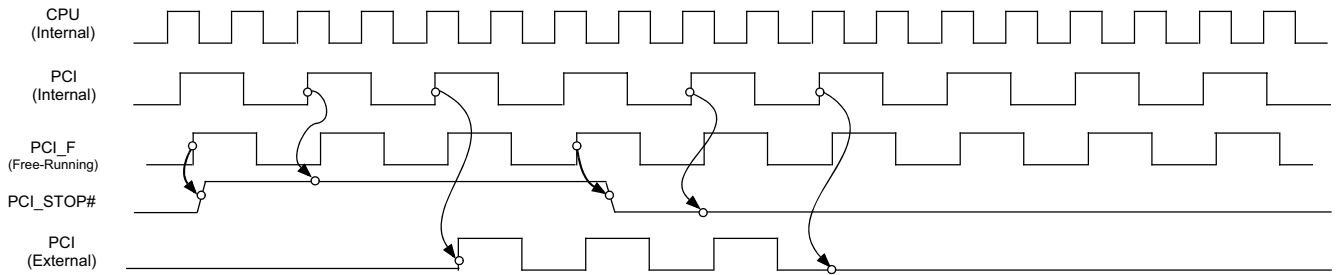
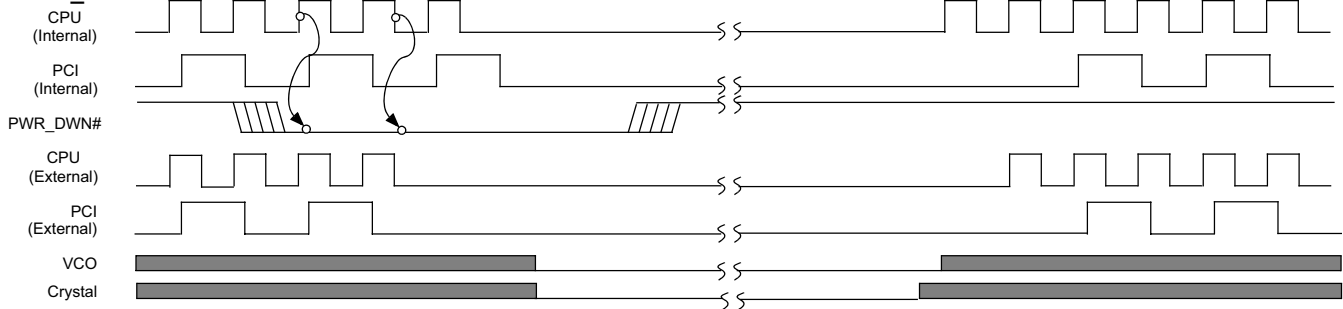
IOAPIC-IOAPIC Clock Skew

3V66 - 3V66 Clock Skew

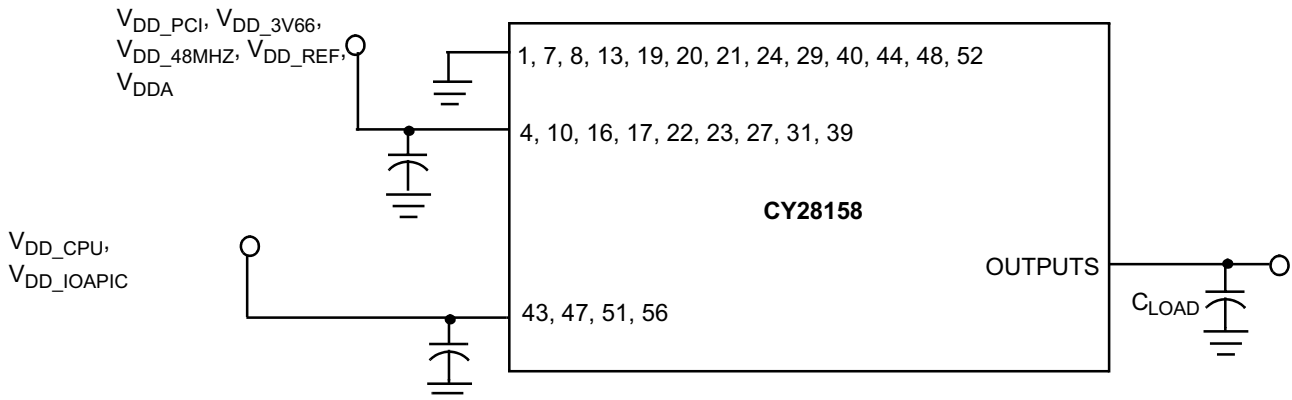
Switching Waveforms (continued)
PCI-PCI Clock Skew

CPU - 3V66 Clock Skew

3V66 - PCI Clock Skew

CPU-IOAPIC Clock Skew

CPU_STOP# Timing^[7, 8]

Notes:

- 7. CPU on and CPU off latency is 2 or 3 CPU cycles.
- 8. CPU_STOP# may be applied asynchronously. It is synchronized internally.

Switching Waveforms (continued)
PCI_STOP#

PWR_DWN#

Shaded section on the VCO and Crystal waveforms indicates that the VCO and crystal oscillator are active, and there is a valid clock.

Test Circuit

Note: Each supply pin must have an individual decoupling capacitor on test circuit at 0.1 μ F.

Note: All capacitors must be placed as close to the pins as is physically possible.

Ordering Information

Ordering Code	Package Name	Package Type	Operating Range
CY28158PVC	O56	56-Pin SSOP	Commercial
CY28158PVCT	O56	56-Pin SSOP- Tape and Reel	Commercial
Lead Free			
CY28158OXC	O56	56-Pin SSOP	Commercial
CY28158OXCT	O56	56-Pin SSOP- Tape and Reel	Commercial

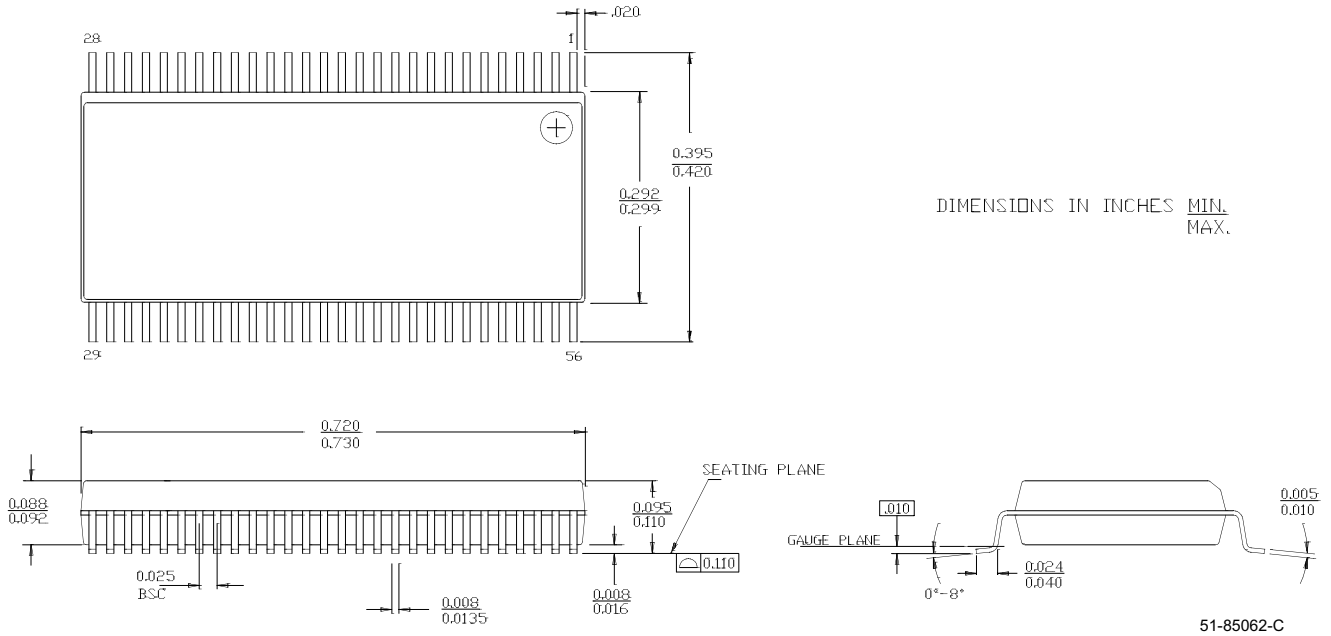
Package Diagram
56-Lead Shrunken Small Outline Package O56

While SLI has reviewed all information herein for accuracy and reliability, Spectra Linear Inc. assumes no responsibility for the use of any circuitry or for the infringement of any patents or other rights of third parties which would result from each use. This product is intended for use in normal commercial applications and is not warranted nor is it intended for use in life support, critical medical instruments, or any other application requiring extended temperature range, high reliability, or any other extraordinary environmental requirements unless pursuant to additional processing by Spectra Linear Inc., and expressed written agreement by Spectra Linear Inc. Spectra Linear Inc. reserves the right to change any circuitry or specification without notice.