

GP2W0116YPS

IrDA Transceiver Module Compliant with IrDA1.2 Low Power

■ Features

1. Compliant with IrDA1.2 low power
2. Integrated package of transmitter/receiver.
(7.2×2.75×height 1.85mm)
3. General purpose
4. Low dissipation current due to shut-down function
(Dissipation current at shut-down mode:Max. 0.1μA)
5. Soldering reflow type
6. Shield type

■ Applications

1. Cellular phones, PHS
2. Personal information tools

■ Absolute Maximum Ratings (T_a=25°C)

Parameter	Symbol	Rating	Unit
Supply voltage	V _{CC}	0 to 6.0	V
LED Supply voltage	V _{LEDA}	0 to 7.0	V
^{*1} Peak forward current	I _{FM}	60	mA
Operating temperature	T _{opr}	-40 to +85	°C
Storage temperature	T _{stg}	-40 to +85	°C
^{*2} Soldering temperature	T _{sol}	260	°C

^{*1} Pulse width 78.1μs, Duty ratio:3/16

^{*2} For MAX. 10s

■ Recommended Operating Conditions

Parameter	Symbol	Rating	Unit
Supply voltage	V _{CC}	2.0 to 3.6	V
LED Supply voltage	V _{LEDA}	2.0 to 6.0	V
Transmission rate	BR	2.4 to 115.2	kb/s
High level input voltage (SD terminal)	V _{IHSD}	V _{CC} ×0.67 to V _{CC}	V
Low level input voltage (SD terminal)	V _{ILSD}	0 to V _{CC} ×0.1	V
^{*3} High level input voltage (TXD)	V _{IHTXD}	V _{CC} ×0.8 to V _{CC}	V
^{*3} Low level input voltage (TXD)	V _{ILTXD}	0 to V _{CC} ×0.2	V

^{*3} Refer to Fig.9

■ Outline Dimensions

(Unit : mm)

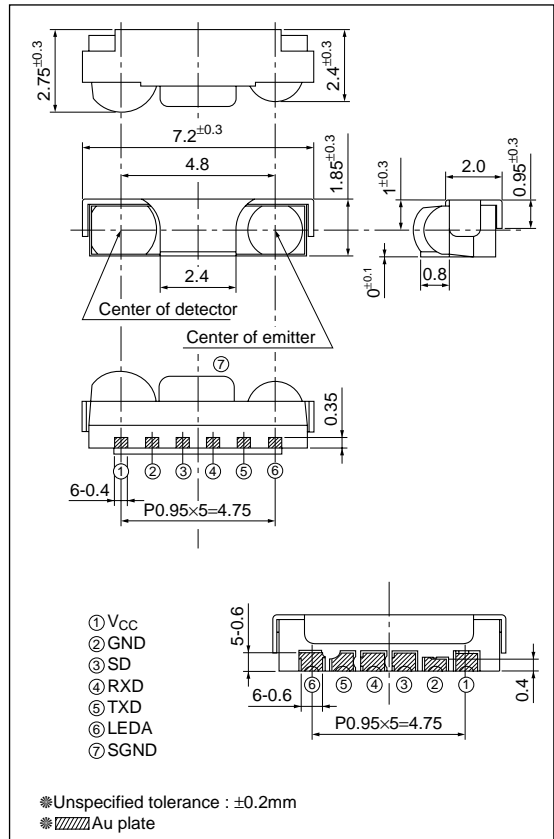

■ Electro-optical Characteristics

(T_a=25°C, V_{CC}=3.3V)

	Parameter	Symbol	Conditions	MIN.	TYP.	MAX.	Unit
Receiver side	Dissipation current at no input signal	I _{CC}	No input light, output terminal open, V _{IHSD} =0V	–	90	120	μA
	S/D dissipation current	I _{CC-s}	No input light, output terminal open, V _{IHSD} =V _{CC}	–	0.001	0.1	μA
	High level output voltage	V _{OH}	I _{OH} =-200μA, V _{CC} =2.0 to 3.6V *4	V _{CC} -0.4	–	–	V
	Low level output voltage	V _{OL}	I _{OL} =200μA, V _{CC} =2.0 to 3.6V *4	–	–	0.45	V
	Low level pules width	t _w	BR=115.2kb/s, φ≤15°, C _L =10pF *4	1.28	–	6.0	μs
	Rise time	t _r	BR=115.2kb/s, φ≤15°, C _L =10pF *4	–	–	0.06	μs
	Fall time	t _f	BR=115.2kb/s, φ≤15°, C _L =10pF *4	–	–	0.06	μs
	Maximum communication distance	L	BR=115.2kb/s, φ≤15° *4	21	–	–	cm
Transmitter side	Radiant intensity	I _E	BR=115.2kb/s, φ≤15°, V _{IHTXD} =2.8V *5	4.0	–	25	mW/sr
	Peak emission wavelength	λ _p		850	870	900	nm

*4 Refer to Fig.4, 5, 6

*5 Refer to Fig.7, 8, 9

Fig.1 Recommended External Circuit

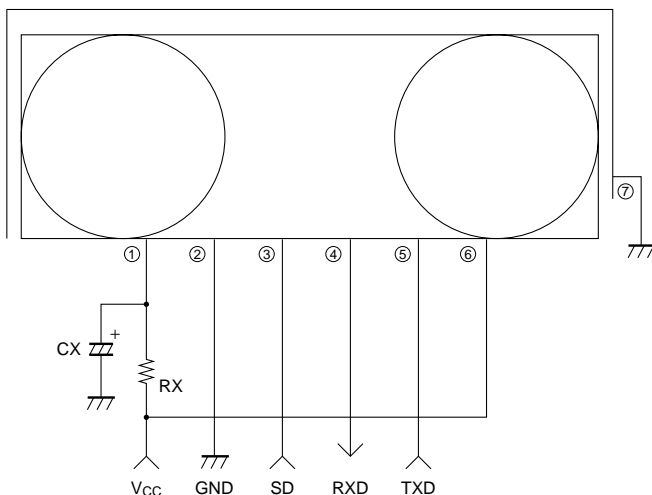

- ① VCC
- ② GND
- ③ SD
- ④ RXD
- ⑤ TXD
- ⑥ LEDA
- ⑦ SGND

Components	Recommended values
CX	1μF/6.3V
RX	1 to 15Ω

(Note) Please choose the most suitable CX according to the noise level and noise frequency of power supply.

Depend on noise level and noise frequency of power supply, CX does not work well.

There are cases that some pulse noises from RXD other than signal will occur in certain communication area. Please check by finish product that there are no problem at all communication area and data rate.

If there are any problem, please check by inserting RX (1 to 15Ω) in the circuit drawing.

*I/O Logic table

SD	TXD	LED	Receiver	TR1	TR2	RXD
Low	High	ON	Don't care	–	–	Not valid
	Low	OFF	IrDA signal	OFF	ON	Low
High	Don't care	OFF	No signal	ON	OFF	High
			Don't care	OFF	OFF	Pull-up

*RXD Equipment circuit

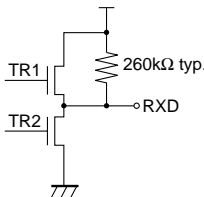
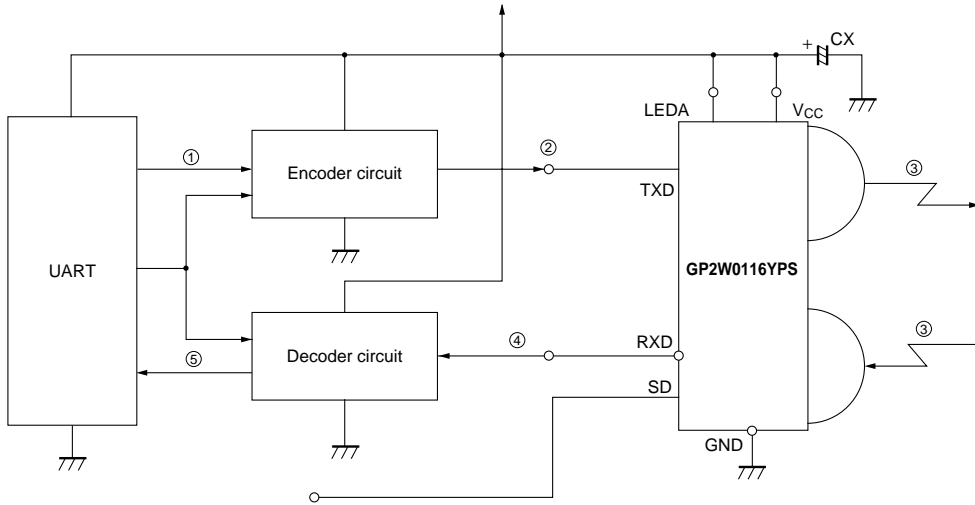
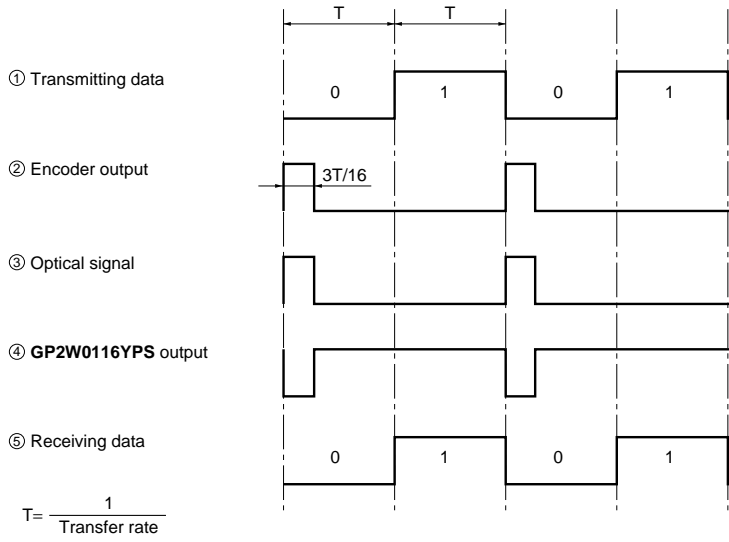

Fig.2 System Configuration



SD input	Performance
Low	Normal mode
High	Shut down mode

Fig.3 Example of Signal Waveform



Transfer rate ; 2.4kb/s,9.6kb/s,19.2kb/s,38.4kb/s,57.6kb/s,115.2kb/s

Fig.4 Input Signal Waveform (Receiver side)

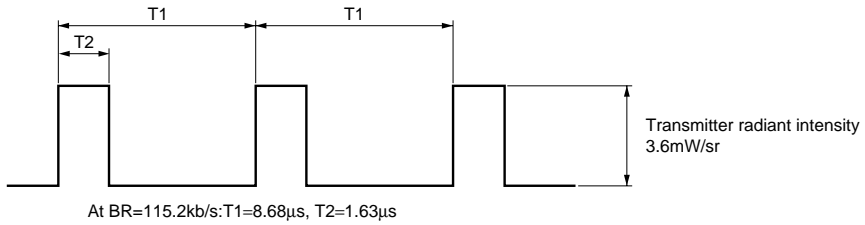

Fig.5 Output Waveform Specification (Receiver side)

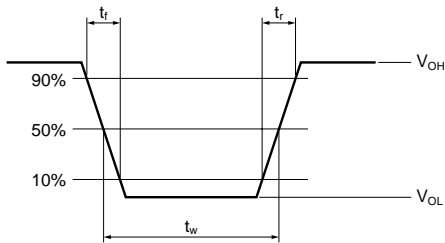
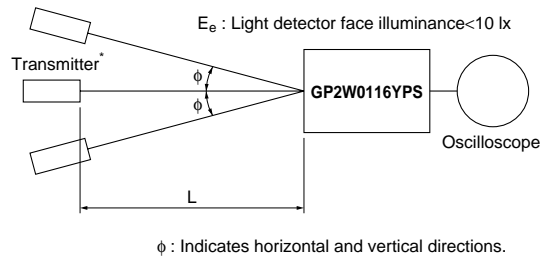

Fig.6 Standard Optical System (Receiver side)



* Transmitter shall use GP2W0116YPS ($\lambda_p=870\text{nm}$ TYP.) which is adjusted the radiation intensity at 3.6mW/sr

Fig.7 Output Waveform Specification (Transmitter side)

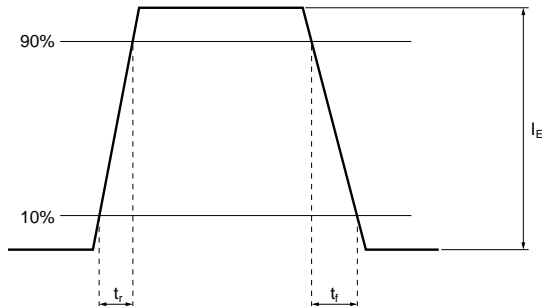
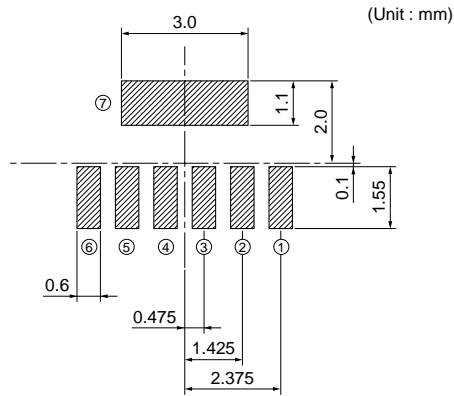

Fig.11 Recommended Size of Solder Paste (Reference)

Please open the solder mask as below so that the size of solder paste for this device before reflow soldering must be as large as one of the foot pattern land indicated Fig.10



▨ : Solder paste area

NOTICE

- The circuit application examples in this publication are provided to explain representative applications of SHARP devices and are not intended to guarantee any circuit design or license any intellectual property rights. SHARP takes no responsibility for any problems related to any intellectual property right of a third party resulting from the use of SHARP's devices.
- Contact SHARP in order to obtain the latest device specification sheets before using any SHARP device. SHARP reserves the right to make changes in the specifications, characteristics, data, materials, structure, and other contents described herein at any time without notice in order to improve design or reliability. Manufacturing locations are also subject to change without notice.
- Observe the following points when using any devices in this publication. SHARP takes no responsibility for damage caused by improper use of the devices which does not meet the conditions and absolute maximum ratings to be used specified in the relevant specification sheet nor meet the following conditions:
 - (i) The devices in this publication are designed for use in general electronic equipment designs such as:
 - Personal computers
 - Office automation equipment
 - Telecommunication equipment [terminal]
 - Test and measurement equipment
 - Industrial control
 - Audio visual equipment
 - Consumer electronics
 - (ii) Measures such as fail-safe function and redundant design should be taken to ensure reliability and safety when SHARP devices are used for or in connection with equipment that requires higher reliability such as:
 - Transportation control and safety equipment (i.e., aircraft, trains, automobiles, etc.)
 - Traffic signals
 - Gas leakage sensor breakers
 - Alarm equipment
 - Various safety devices, etc.
 - (iii) SHARP devices shall not be used for or in connection with equipment that requires an extremely high level of reliability and safety such as:
 - Space applications
 - Telecommunication equipment [trunk lines]
 - Nuclear power control equipment
 - Medical and other life support equipment (e.g., scuba).
- If the SHARP devices listed in this publication fall within the scope of strategic products described in the Foreign Exchange and Foreign Trade Law of Japan, it is necessary to obtain approval to export such SHARP devices.
- This publication is the proprietary product of SHARP and is copyrighted, with all rights reserved. Under the copyright laws, no part of this publication may be reproduced or transmitted in any form or by any means, electronic or mechanical, for any purpose, in whole or in part, without the express written permission of SHARP. Express written permission is also required before any use of this publication may be made by a third party.
- Contact and consult with a SHARP representative if there are any questions about the contents of this publication.