

ADVANCED INFORMATION

INDUCTIVE WHITE LED DRIVER WITH SYNCHRONOUS RECTIFIER

FEATURES

- Minimum External Components
- Efficiency as High as 80%
- LED Current Regulated
- Internal Synchronous Rectifier
- PWM Signal Intensity Control
- Can Drive Multiple Strings of 3 WLED in Series
- 700 kHz PWM Operation
- Low Supply Current
- Enable Pin
- Short Circuit Protection
- Over Voltage Protection
- 8 Pin Flip Chip Package

DESCRIPTION

Toko's TK65600 White LED Driver IC has been optimized for battery controlled systems where power consumption and size are primary concerns. High efficiency has been optimized for this application.

The miniature Flip Chip package device, together with the miniature Toko Coil D31FB or Low Profile D412F Coil, further helps system designers reduce the space required to drive the white LEDs.

The IC uses Current-mode PWM (Pulse Width Modulation) method of regulating the current through the string of LEDs. This time-proven method of regulation works at a fixed switching frequency which is preferred in RF systems, because the switching noise RF spectrum is more predictable. With a switching frequency of 700 kHz the operation of the IC should not disturb 455 kHz IF subsystem.

APPLICATIONS

- LCD Modules
- Cellular Telephone
- Battery Powered Systems
- Consumer Electronics

The Enable pin can take a PWM signal provided by the user to reduce the display brightness. A PWM signal is preferred to pulse the LEDs with a regulated value of current and to maintain better consistency of chromaticity.

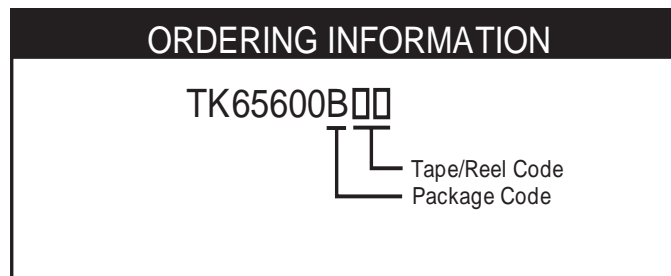
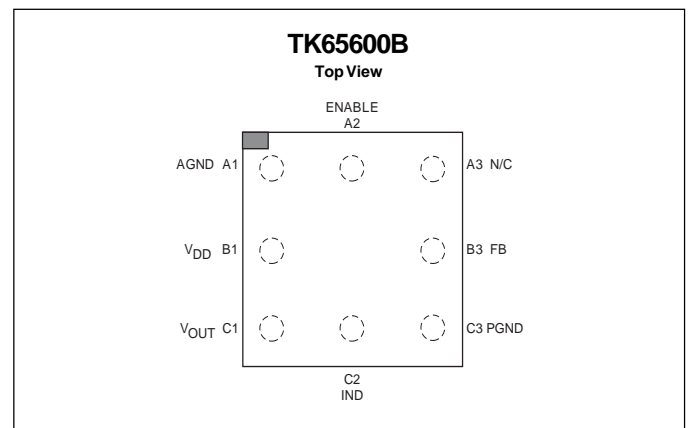

TAPE/REEL CODE
PACKAGE CODE

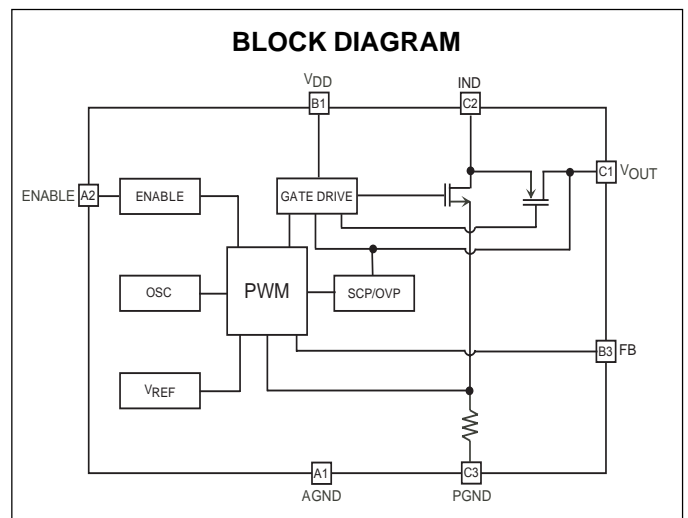

ABSOLUTE MAXIMUM RATINGS

All Pins except IND, V_{OUT} and GND 6 V
 IND, and V_{OUT} PINS 16.5 V
 Storage Temperature Range -55 to +150 °C

Operating Temperature Range -30 to +85 °C
 Junction Temperature T_{JMax} (Note 3) 150 °C
 Package Power Dissipation $T_A = 25^\circ\text{C}$ (Note 3) 560mW
 θ_{JA} Thermal Resistance (Note 3) 220°C/W

TK65600B ELECTRICAL CHARACTERISTICS

$V_{DD} = 3.7\text{ V}$, $T_A = T_j = 25^\circ\text{C}$, unless otherwise specified.

	SYMBOL	PARAMETER	TEST CONDITIONS	MIN	TYP	MAX	UNITS
V _{DD} Pin Operation	V _{DD}	Input Supply Range		2.7	3.7	5.5	V
	I _{DD}	Quiescent Current in V _{DD} PIN	V _{EN} ≥ 1.2 V		150	500	μA
	I _{STB}	Standby Current	V _{EN} ≤ 0.3 V			2	μA
Enable Pin Operation	V _{EN(on)}	Enable Full On Voltage	Output on	1.2		V _{DD} +0.3	V
	V _{EN(off)}	Enable Off Voltage	Output off	-0.3		0.3	V
	I _{EN}	Enable Pin Current		-5			μA
IND Pin Operation	I _{LIM}	Boost FET Current Limit Setting				400	mA
			T _A = -30 to +85°C (Note 4)				
R _{DS(ON)}	Boost FET On Resistance				1.5		Ω
V _{OUT} Pin Operation	OVP	Over Voltage Protection	No Load	13.5	14.5	15.5	V
			T _A = -30 to +85°C (Note 4)				
	R _{SYNCH}	Synchronous Rectifier on Resistance			3.0		Ω
FB Pin Operation	V _{FB}	Feedback Reference Voltage		0.46	0.5	0.53	V
			T _A = -30 to +85°C (Note4)				
	I _{LED(SET)}	Average Current flowing through LED	V _{EN} ≥ 1.2 V, (Sense resistor = 33.2Ω, 1%)	14	15	16	mA
	I _{LED(VAR)}	Variation of Average Current through LED	V _{EN} ≥ 1.2V 2.7V < V _{IN} < 5.5 V	-1.5	I _{LED(SET)}	+1.5	%
I _{LED(LINE)}	I _{LED} LINE Regulation	V _{EN} ≥ 1.2V 2.7V < V _{IN} < 5.5 V I _{LED} = 15 mA (Note 1)			0.161	mA/V	

TK65600B ELECTRICAL CHARACTERISTICS

$V_{DD} = 3.7\text{ V}$, $T_A = T_j = 25\text{ }^\circ\text{C}$, unless otherwise specified.

	SYMBOL	PARAMETER	TEST CONDITIONS	MIN	TYP	MAX	UNITS
Boost Converter Operation	F_{BOOST}	Boost Frequency		575	700	825	kHz
			$T_A = -30\text{ to }+85\text{ }^\circ\text{C}$ (Note 4)				
	$DC_{(\text{MAX})}$	Boost Maximum Duty Cycle			85	95	%
			$T_A = -30\text{ to }+85\text{ }^\circ\text{C}$ (Note 4)				
	ΔV_{OUT}	Output Voltage Ripple	(Note 1)		50		mV
	$P_{\text{OUT MAX}}$	Maximum Power Output	$V_{\text{IN}} = 3\text{V}$	300			mW
$T_A = -30\text{ to }+85\text{ }^\circ\text{C}$ (Note4)							
EFF	Boost Converter Efficiency	$I_{\text{LED}} = 15\text{mA}$ (Note 1,2) $L = 27\text{ }\mu\text{H}$ D31FB		78		%	
		$I_{\text{LED}} = 15\text{mA}$ (Note 1,2) $L = 22\text{ }\mu\text{H}$ D3313FB		72		%	
T_{START}	Start-Up Settling Time	(Note 1)		300		μs	

Note 1: When using test circuit below.

Note 2: Converter efficiency is partly dependent upon the DC resistance of inductor L_r . Higher DC resistances will result in lower converter efficiency.

Note 3: The Absolute Maximum Power Dissipation depends upon the Ambient Temperature and can be calculated using the formula $P_{\text{DMAX}} = (T_{\text{JMAX}} - T_A) / \theta_{\text{JA}}$

Note 4: Verified by design.

TYPICAL APPLICATION AND TEST CIRCUIT

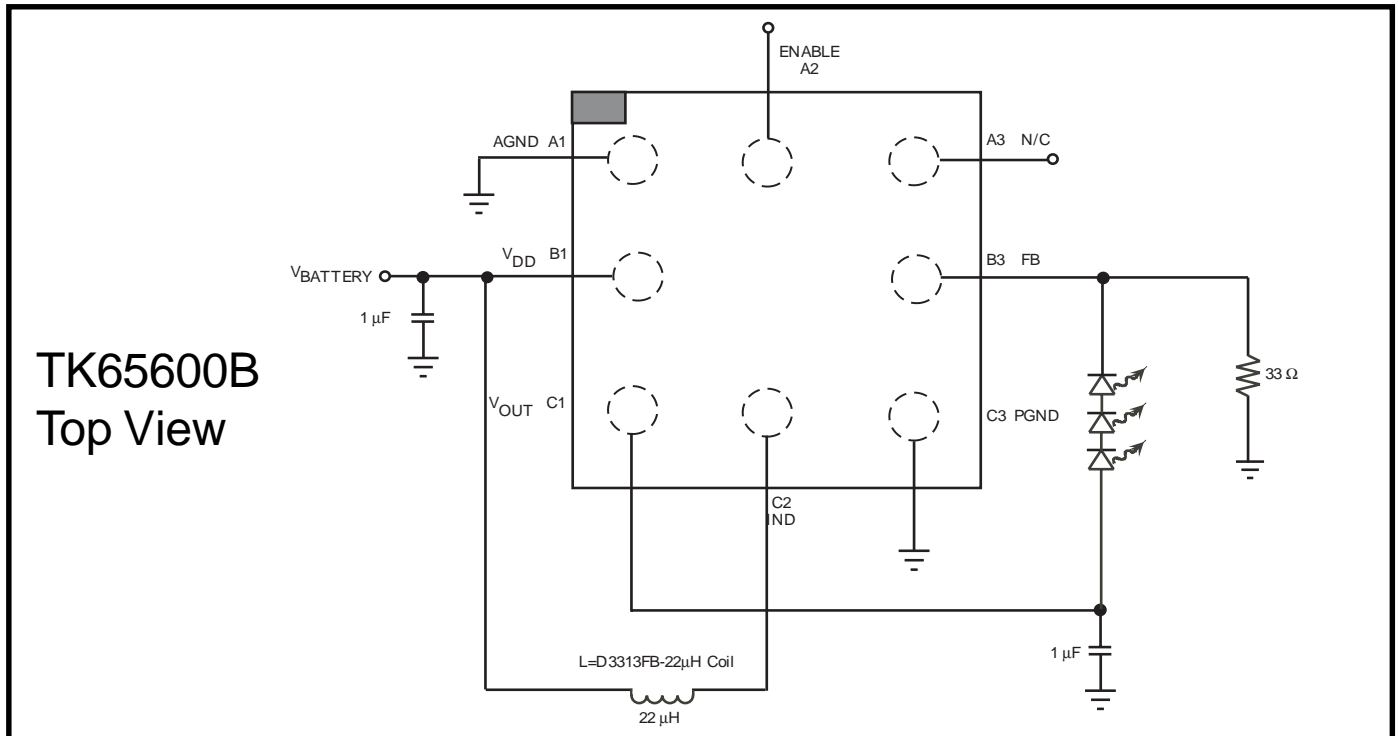

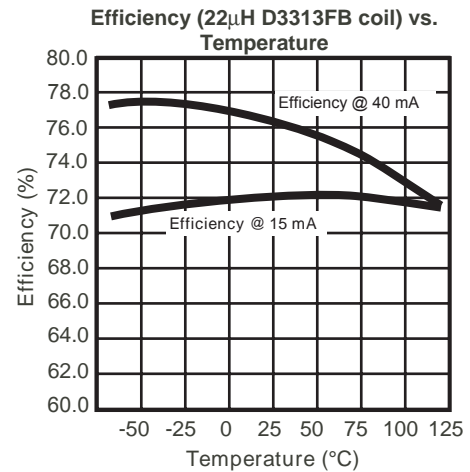
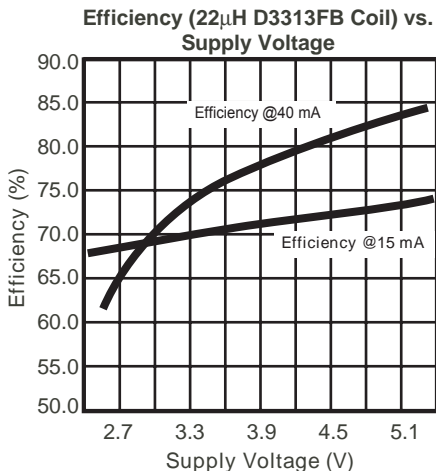
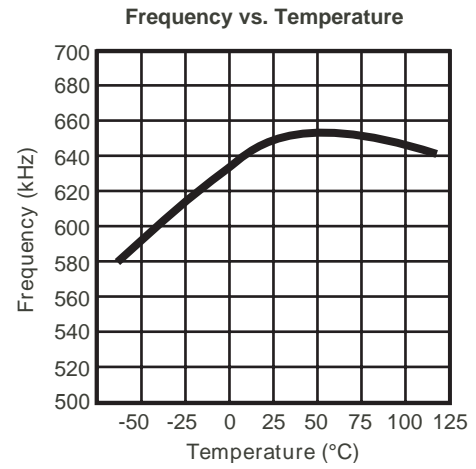
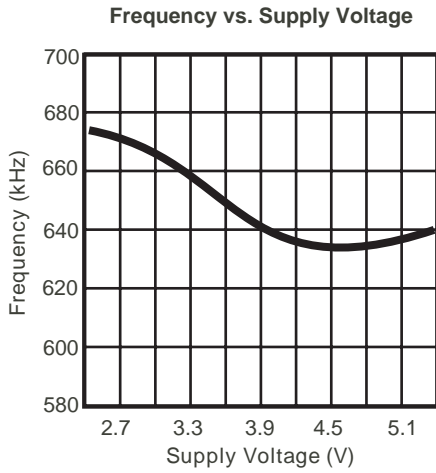
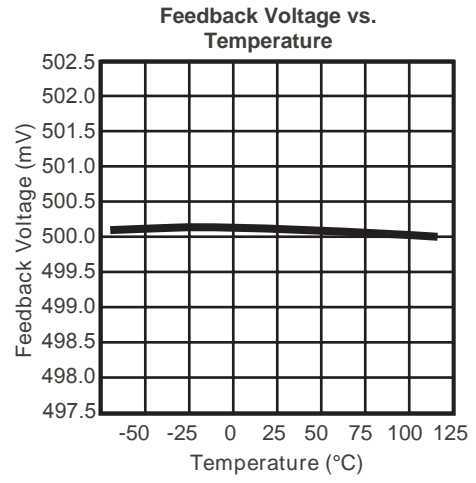
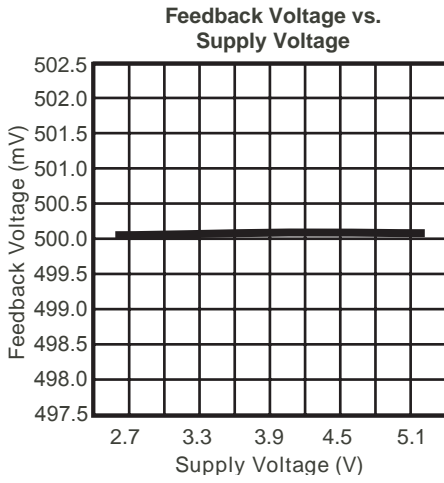

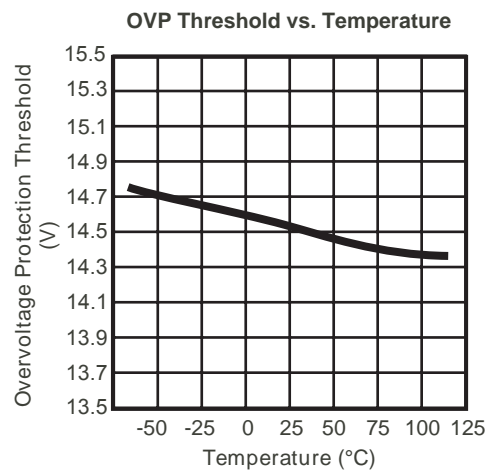
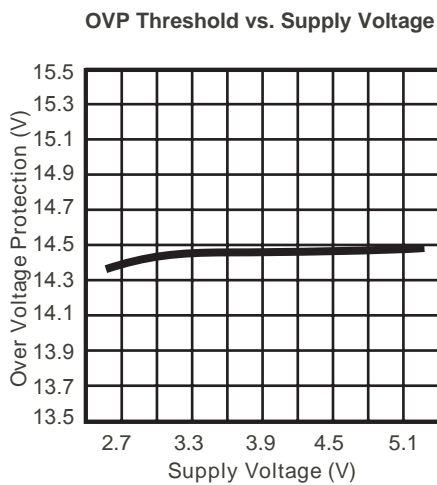
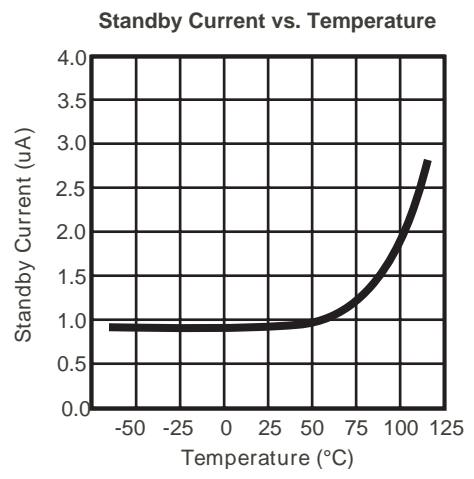
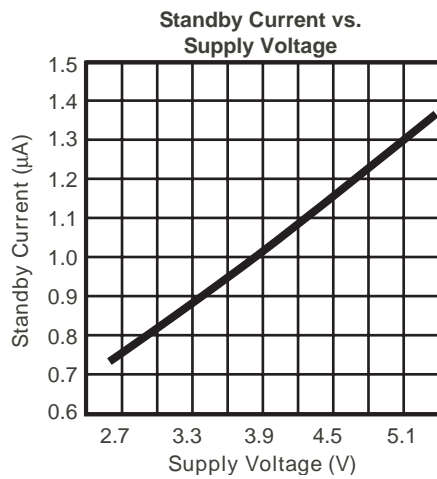
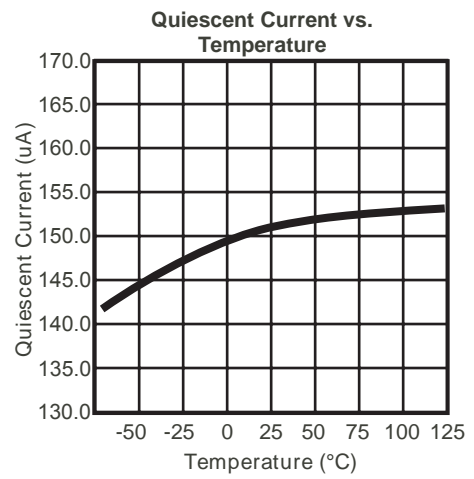
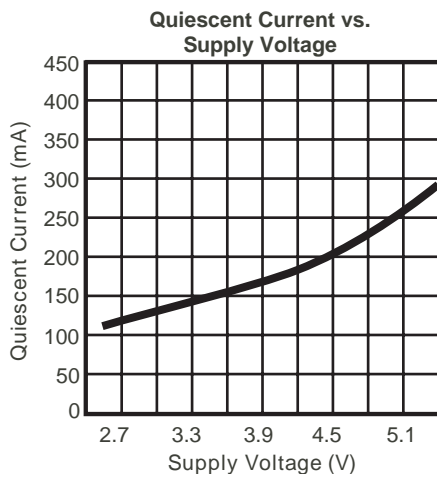

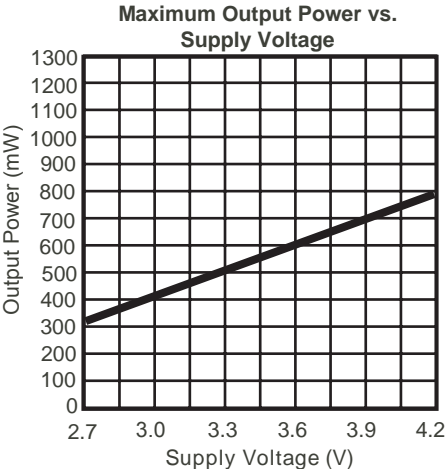

Supply Voltage Characteristics

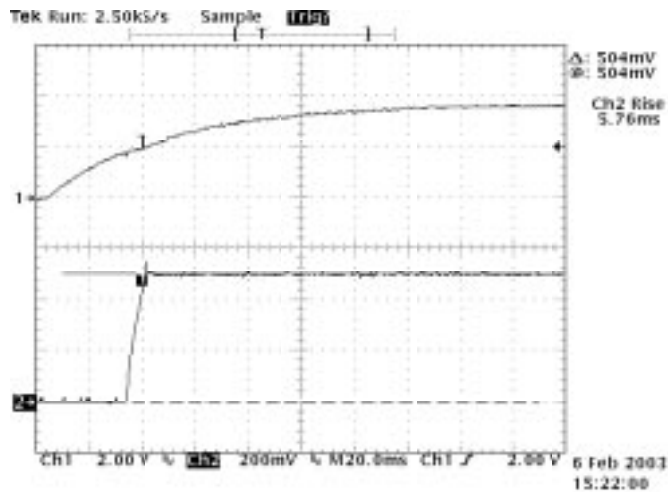

Channel 1 is Supply Voltage
Channel 2 is the Feedback Voltage coming up to regulation.

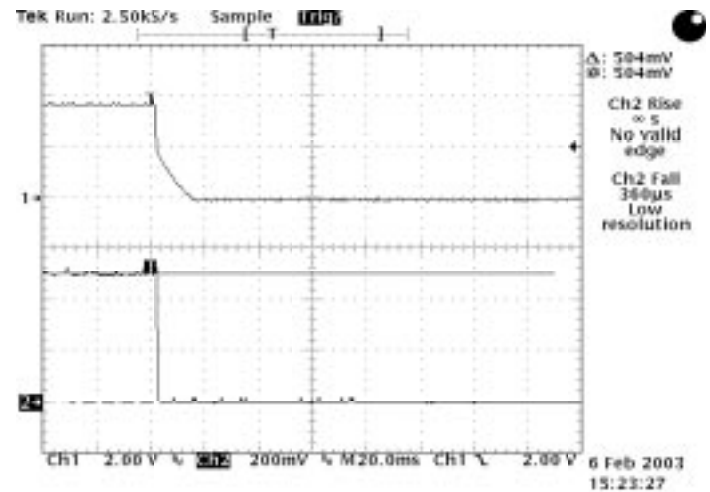

Channel 1 Supply Voltage turns off
Channel 2 Feedback Voltage follows.

Enable Characteristics

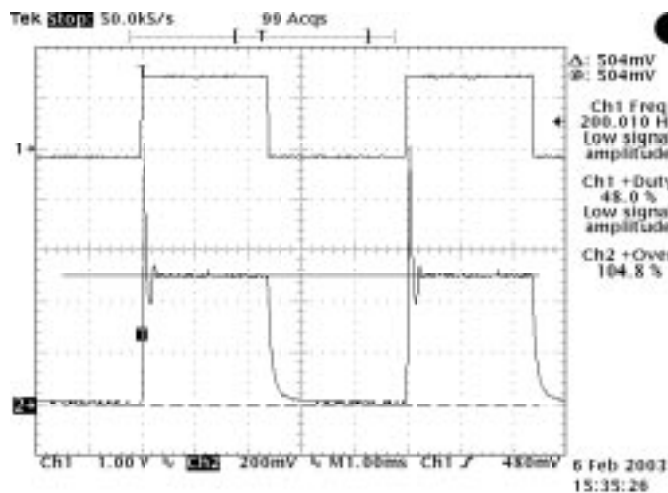

Channel 1 is the Enable waveform to create a change in intensity
Channel 2 shows the Feedback Voltage reacting to the Enable signal.

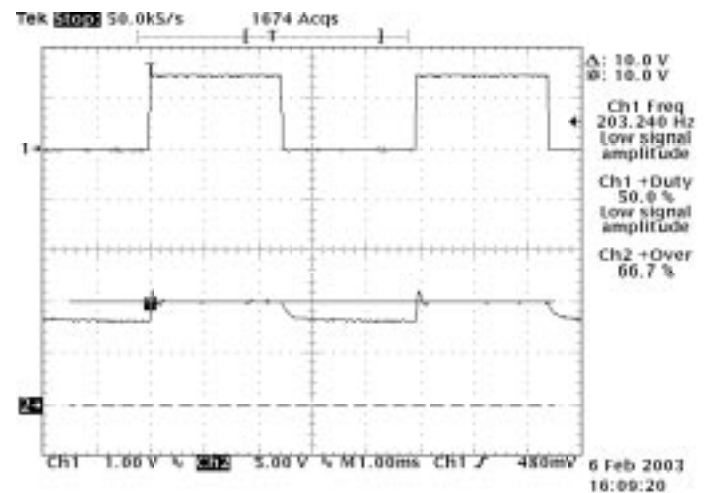

Channel 1 is the Enable waveform
Channel 2 Output Voltage reacting to Enable signal

Theory of Operation

The TK65600 is an inductive white LED driver circuit. The input voltage is 2.7V up to 6V. The load is represented by white LED's - one or more parallel strings of LED's, each string consisting of two or more LED's connected in series. The absolute maximum voltage allowed at the output pin is 16V, dictated by wafer process limits. The forward drop voltage of the LED's dictates how many LED's can be in a string, as the voltage at the output pin is the voltage across the LED's in series in a string, plus the voltage drop across the feedback resistor. The feedback resistor appears in series with the load, connected between the bottom terminal of the LED string(s) and ground.

The minimum input voltage of 2.7V and the maximum output voltage of about 15V requires this circuit to be a boost circuit - TK65600 is an inductive boost circuit. The circuit regulates the current in the load, as the light intensity of the LED's depends on the current flowing through them. The LED current information is provided by a feedback resistor, connected between the load and ground. A classical current -mode control loop, using pulse width modulation (PWM) at a fixed frequency, regulates the boost circuit output, such as to maintain the current in the LED's constant.

As with any classical current -mode control loop PWM, the boost converter has the feature of pulse by pulse current limiting. On the TK65600 that current loop limit is set to about 400mA. Therefore, the inductor, which is to be used with the TK65600, should have an I_{sat} above 400mA.

There are a few additional functions the circuit incorporates:

- Disable - allows the circuit to be turned on and off by an external enable signal (off for $V_{enable} < 0.3V$, on for $V_{enable} > 1.2V$)
- Over-Voltage Protection (OVP) - shuts off the power FET's if the output voltage rises above a predetermined threshold (14V). This is intended to prevent damage to the circuit for an open load condition, for instance, by not allowing the output voltage to rise above the preset limit.
- Short-Circuit Protection (SCP) - if the output sees an unusually high load or a short-circuit, there is circuitry provided that will cut off the current path to the output, wait a predetermined amount of time, then attempt to restart. If the output short-circuit or heavy loading condition at the output disappeared, the circuit will start and function normally. If the short-circuit condition persists, the circuit will wait again the predetermined amount of time, then it will attempt to restart again. The high load or short-circuit condition is identified, for the purpose of this feature, by a low output voltage (less than 1.2V). In order to provide for start-up condition (when the output voltage is inherently low), the SCP circuitry waits for a little while, before asserting the short circuit condition signal. That little while is set now at sixteen (16) clock cycles, while the reset time, that is, the time before the circuit attempts to restart, it is set now at (512) clock cycles. With a clock of 600kHz, these times are approximately 27us for asserting the short circuit condition signal and about 853us between attempts to restart the boost circuit.

Theory of Operation Cont.

A classic boost configuration is not able to provide short circuit protection, as the input voltage source can provide current to the load, through the inductor and diode, even if the circuit is disabled. A synchronous rectifier is required, in order to be able to provide short circuit protection.

The synchronous rectifier (Msr) is replacing the diode found in classic boost circuits. The main advantage is eliminating the need for an external component. The second important advantage is the potential for less voltage drop across this device. A serious drawback is the fact that a FET is a non-directional device, unlike the diode it replaces, so, while the diode operated by itself, careful control of the synchronous rectifier operation is required. The synchronous rectifier must be off, at all times when the inductor switch is on - otherwise, shoot-through current from the boost capacitor, through the synchronous rectifier and through the inductor switch, to the ground, can occur - this cannot be allowed to happen, because of its effect on efficiency.

A second issue to consider when driving the synchronous rectifier is the fact that, the FET being a non-directional device, the drive circuitry must ensure that the synchronous rectifier is on only when the boost voltage (output) is smaller than the voltage at the inductor node - otherwise, the boost (output) capacitor will discharge through the synchronous rectifier FET and inductor, to the input voltage source (Vdd).

When the inductor switch is off and the synchronous rectifier it is held off because the inductor voltage is smaller than the boost voltage, both power FET's (Mind and Msr) are off. When this happens, the remaining energy in the inductor may be enough to start ringing, using the inductor and whatever parasitic capacitance can find (both Mind and Msr are large devices, with large parasitic capacitance). The resulting oscillations can be large enough to trigger the hysteresis comparator in the internal synchronous rectifier driver circuitry. Also, this ringing oscillation may cause noise in other parts of the application's system. To avoid these effects, a snubber circuit is used, to short the inductor node not to ground (that would be a loss of energy), but back to Vdd (charging back the source). The snubber circuit must carefully select the moment when Mind and Msr are off, following the current ramp-up in the inductor, and NOT preceding it. The state machine inside the snubber does that. There is another moment when both Mind and Msr are off at the same time - when the inductor switch is cut off, after ramping the current in the inductor, but the synchronous rectifier, Msr, is not yet on (due to delays in circuitry, etc.). At this point in time, the inductor node voltage is highest and no snubber effect is acceptable.

PIN DESCRIPTION

Pin No.	Symbol	Description
A1	AGND	Analog Ground pin. This pin provides return current path to low power circuits supplied current through the VDD pin. In the circuit board connect to PGND pin at ground plane.
A2	ENABLE	Enable input pin. This pin turns on the IC to start switching action. Set the Enable Pin higher than 1.2V to enable the IC. Set the Enable pin below 0.3V to disable the IC. Do not leave this pin floating.
A3	N/C	No Connection
B1	V _{DD}	Power Supply pin. This pin supplies power to low voltage (<6V) control circuits in the IC.
B3	FB	Feedback Voltage Regulation Input pin. A low voltage input that is regulated to 500mV
C1	V _{OUT}	Output Voltage pin. This pin supplies the voltage to drive the White LEDs. It is a high voltage pin (<16.5V) which is protected by an over voltage protect circuit, which stops the IC switching if this pin reaches about 14.5V
C2	IND	Inductor Connection pin. This pin is also a high voltage pin and is connected to the internal boost N-channel MOSFET
C3	PGND	Power Ground pin. This pin provides return current path to high currents flowing to ground through the IND and VOUT pins. In the circuit board connect to AGND pin through ground plane.

APPLICATION NOTES

As with all switching power converters, care should be given to the circuit board layout. The bolded lines, on the schematic below, show where the high current paths of switched currents are in the circuit. The circuit board traces for these paths should be short and wide to minimize the power losses and electromagnetic interference generated from the switching currents. Therefore C_{IN} , L and C_{OUT} should be located close to the IC in the circuit board layout. Also, the circuit board layout should keep the sense resistor close to the IC such that there is no voltage differences in the ground references. The (AGND) Analog Ground and the Power Ground (PGND) should short as close to the device as possible.

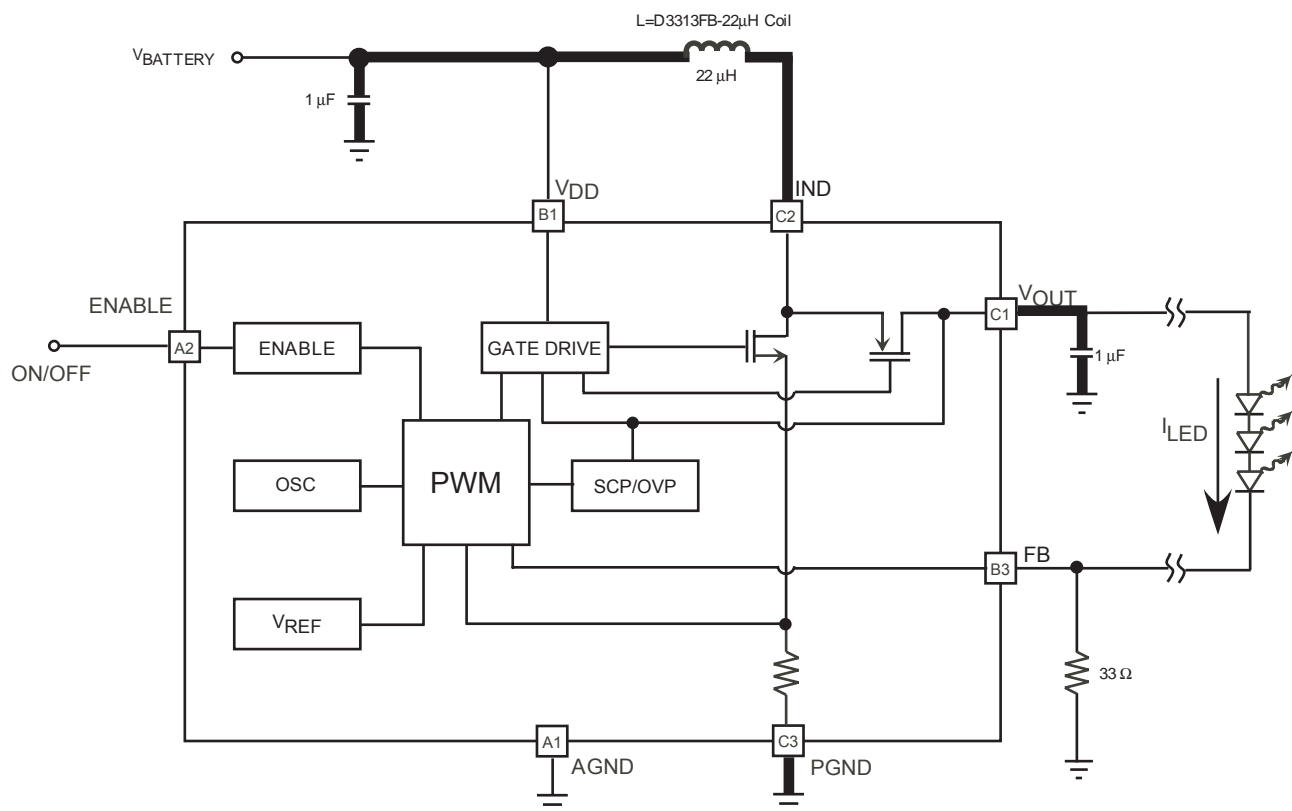

PACKAGE OUTLINE (FLIP CHIP)

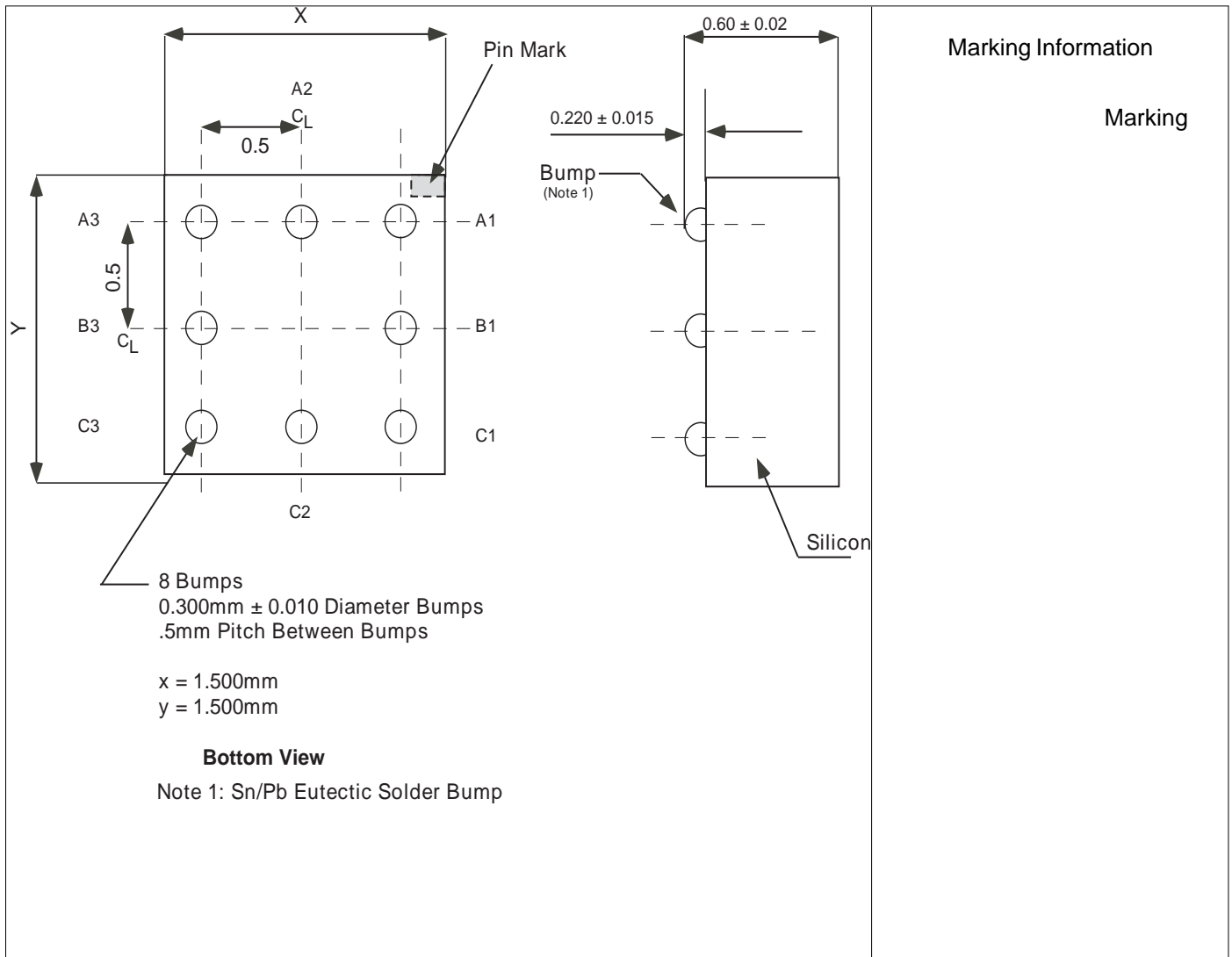

Toko America, Inc. Headquarters
1250 Feehanville Drive, Mount Prospect, Illinois 60056
Tel: (847) 297-0070 Fax: (847) 699-7864

TOKO AMERICA REGIONAL OFFICES

Midwest Regional Office
Toko America, Inc.
1250 Feehanville Drive
Mount Prospect, IL 60056
Tel: (847) 297-0070
Fax: (847) 699-7864

Semiconductor Technical Support
Toko Design Center
4755 Forge Road
Colorado Springs, CO 80907
Tel: (719) 528-2200
Fax: (719) 528-2375

Visit our Internet site at <http://www.toko.com>

The information furnished by TOKO, Inc. is believed to be accurate and reliable. However, TOKO reserves the right to make changes or improvements in the design, specification or manufacture of its products without further notice. TOKO does not assume any liability arising from the application or use of any product or circuit described herein, nor for any infringements of patents or other rights of third parties which may result from the use of its products. No license is granted by implication or otherwise under any patent or patent rights of TOKO, Inc. TOKO's products are not authorized for use as critical components in life support devices or systems without the express written approval of the president of Toko, Incorporated.