

TOSHIBA Photo-IC Silicon Epitaxial Planar

TPS850

Mobile Phones, PHS
 Notebook PCs, PDAs
 Video Cameras, Digital Still Cameras
 Other Equipment Requiring Luminosity Adjustment

The TPS850 is a linear-output photo-IC which incorporates a photodiode and a current amp circuit in a single chip. This photo-IC is current output type, so can set up output voltage freely by arbitrary load resistance.

- High sensitivity: $I_L = 230 \mu\text{A}$
 @ $E_V = 100 \text{ lx}$ (typ.) Using the fluorescent light
- Little fluctuation in light current
 : Width range = $\times 1$ to $\times 1.6$ (typ. $\pm 25\%$)
- Output linearity of illuminance is excellent
- Open-emitter output
- Compact and light surface-mount package
- Lead(Pb)-Free

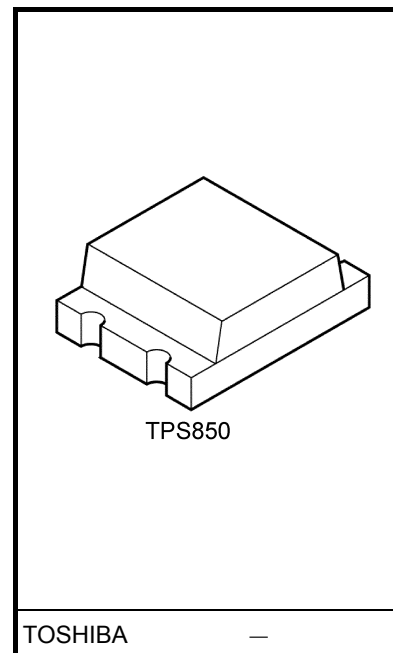

Weight: 0.017 g (typ.)

Absolute Maximum Ratings ($T_a = 25^\circ\text{C}$)

Characteristics	Symbol	Rating	Unit
Supply voltage	V_{CC}	-0.5 to 7	V
Output voltage	V_{OUT}	$\leq V_{CC}$	V
Light current	I_L	10	mA
Permissible power dissipation	P	70	mW
Operating temperature range	T_{opr}	-30 to 85	$^\circ\text{C}$
Storage temperature range	T_{stg}	-40 to 100	$^\circ\text{C}$
Soldering temperature range (10 s) (Note 1)	T_{sol}	260	$^\circ\text{C}$

Note: Using continuously under heavy loads (e.g. the application of high temperature/current/voltage and the significant change in temperature, etc.) may cause this product to decrease in the reliability significantly even if the operating conditions (i.e. operating temperature/current/voltage, etc.) are within the absolute maximum ratings and the operating ranges.

Please design the appropriate reliability upon reviewing the Toshiba Semiconductor Reliability Handbook ("Handling Precautions"/"Derating Concept and Methods") and individual reliability data (i.e. reliability test report and estimated failure rate, etc).

Note 1: The reflow time and the recommended temperature profile are shown in the section entitled Handling Precautions.

Electrical and Optical Characteristics (Ta = 25°C)

Characteristics	Symbol	Test Condition	Min	Typ.	Max	Unit
Supply voltage	V _{CC}	—	2.7	—	5.5	V
Supply current	I _{CC}	V _{CC} = 3 V, E _V = 1000 lx, R _L = 250 Ω (Note 2)	—	4	—	mA
Light current (1)	I _L (1)	V _{CC} = 3 V, E _V = 100 lx (Note 2, 4)	—	300	—	μA
Light current (2)	I _L (2)	V _{CC} = 3 V, E _V = 10 lx (Note 3, 4)	18	23	30	
Light current (3)	I _L (3)	V _{CC} = 3 V, E _V = 100 lx (Note 3, 4)	180	230	300	
Light current ratio	$\frac{I_L (1)}{I_L (3)}$		—	1.3	1.7	
Dark current	I _{LEAK}	V _{CC} = 3.3 V, E _V = 0	—	—	0.5	μA
Saturation output voltage	V _o	V _{CC} = 3 V, R _L = 75 kΩ, E _V = 100 lx (Note 3)	2.2	2.35	—	V
Peak sensitivity wavelength	λ _p	—	—	640	—	nm
Switching time	Rise time	V _{CC} = 3 V, R _L = 5 kΩ, (Note 5)	—	0.2	1	ms
	Fall time		—	0.35	2	

Note 2: CIE standard A light source is used (color temperature = 2856K, approximated incandescence light).

Note 3: Fluorescence light is used as light source. However, white LED is substituted in a mass-production process.

Note 4: Light current measurement circuit

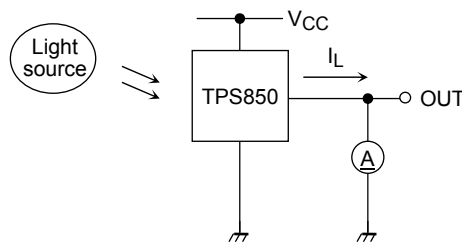

Note 5: Rise time/fall time measurement method

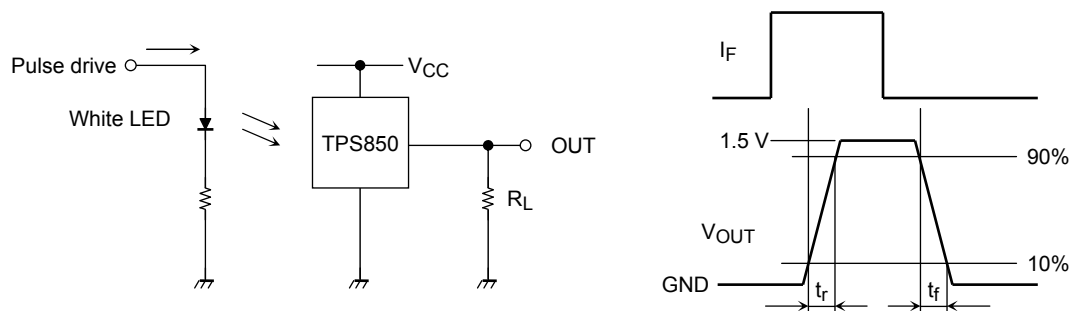

Package Dimensions

TPS850

Unit: mm

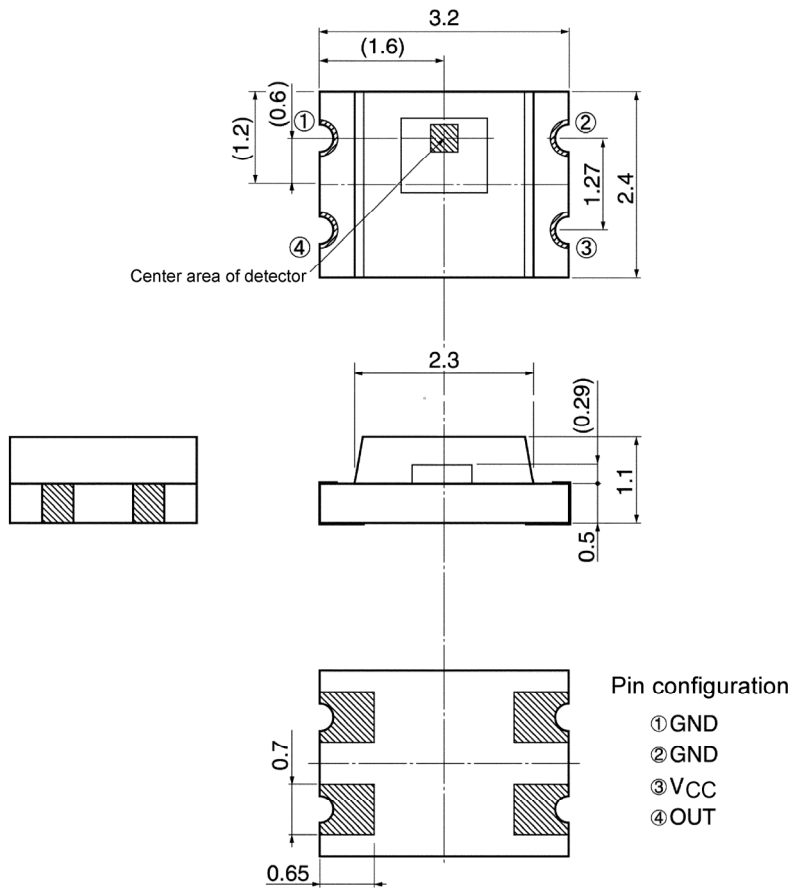

Tolerance: ± 0.2

▨: Sensitive area

Sensitive area: (□0.35)

() : Reference value

Weight: 0.017 g (typ.)

Block Diagram

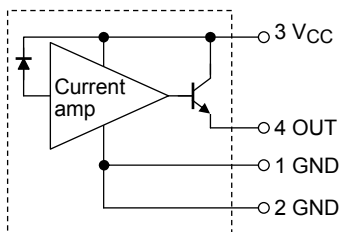

Handling Precautions

At power-on in darkness, the internal circuit takes about 50 ms to stabilize. During this period the output signal is unstable and may change. Please take this into account.

Moisture-Proof Packing

- (1) To avoid moisture absorption by the resin, the product is packed in an aluminum envelope with silica gel.
- (2) Since the optical characteristics of the device can be affected during soldering by vaporization resulting from prior absorption of moisture and they should therefore be stored under the following conditions:

Temperature: 5°C to 30°C, Relative humidity: 60% (max), Time: 168 h

- (3) Baking is required if the devices have been store unopened for more than six months or if the aluminum envelope has been opened for more than 168 h.

These devices are packed on tapes; hence, please avoid baking at high temperature.

Recommended baking conditions: 60°C for 12 h or longer

Mounting Precautions

- (1) Do not apply stress to the resin at high temperature.
- (2) The resin part is easily scratched, so avoid friction with hard materials.
- (3) When installing the assembly board in equipment, ensure that this product does not come into contact with other components.

Mounting Methods

- (1) Reflow soldering
 - Package surface temperature: 260°C (max)
 - Please perform reflow soldering using the following reference temperature profile. Perform reflow soldering no more than twice.

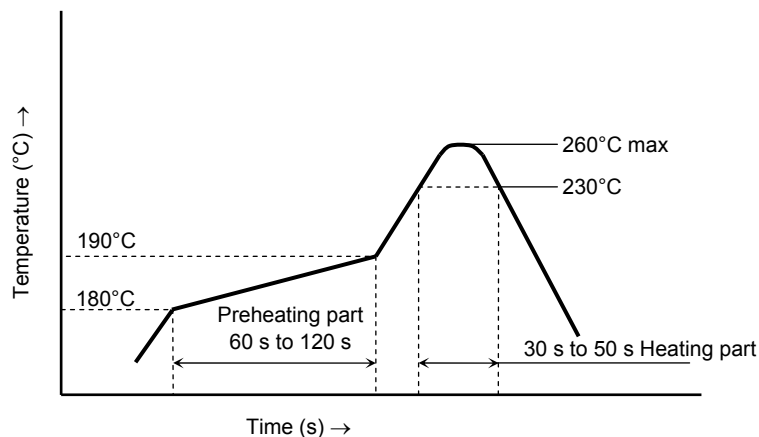

- Please perform the first reflow soldering within 168 h after opening the package with reference to the above temperature profile.
- Second reflow soldering

In case of second reflow soldering, it should be performed within 168 h after first reflow under the above conditions.

Storage conditions before second reflow soldering: 30°C, 60% RH or lower
- Do not perform flow soldering.
- Make any necessary soldering correction manually.

(do not do this more than once for any given pin.)

Temperature: no more than 350°C (25 W for soldering iron)

Time: within 5 s

(2) Recommended soldering pattern

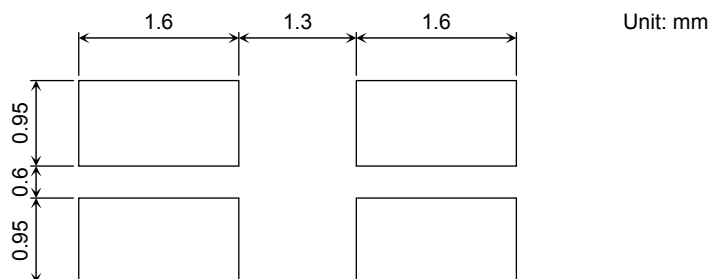

(3) Cleaning conditions

When cleaning is required after soldering

Chemicals: AK225 alcohol

Temperature and time: 50°C × 30 s or : 30°C × 3 minutes

Ultrasonic cleaning: 300 W or less

Packing Specification

(1) Packing quantity

Reel (minimum packing quantity)	3000 devices
Carton	5 reels (15000 devices)

(2) Packing format

An aluminum envelope containing silica gel and reels is deaerated and sealed.

Pack shock-absorbent materials around the aluminum envelopes in the cartons to cushion them.

- Carton specification

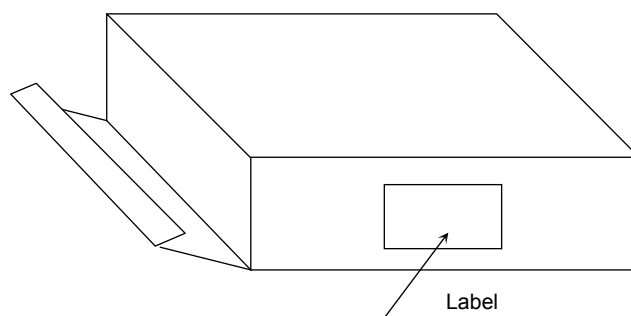

Carton dimensions

(W) 81 mm × (L) 280 mm × (H) 280 mm

Tape Packing Specifications

(1) Reel dimensions

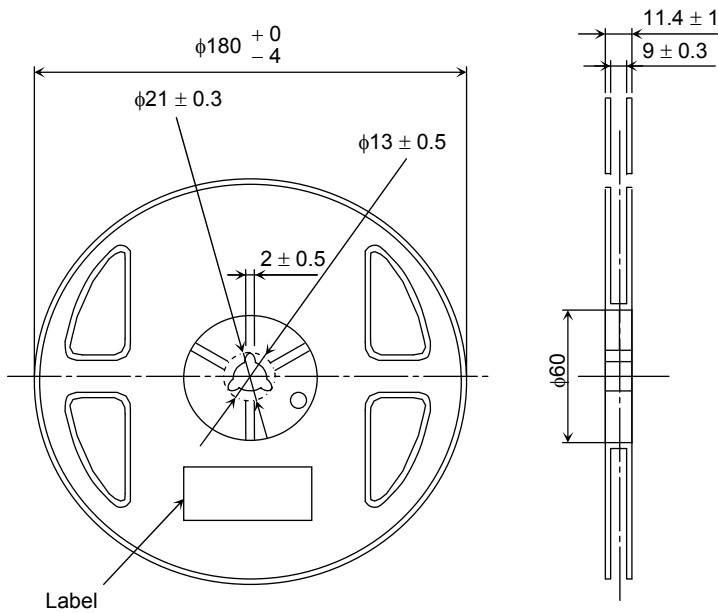

(2) Tape dimensions

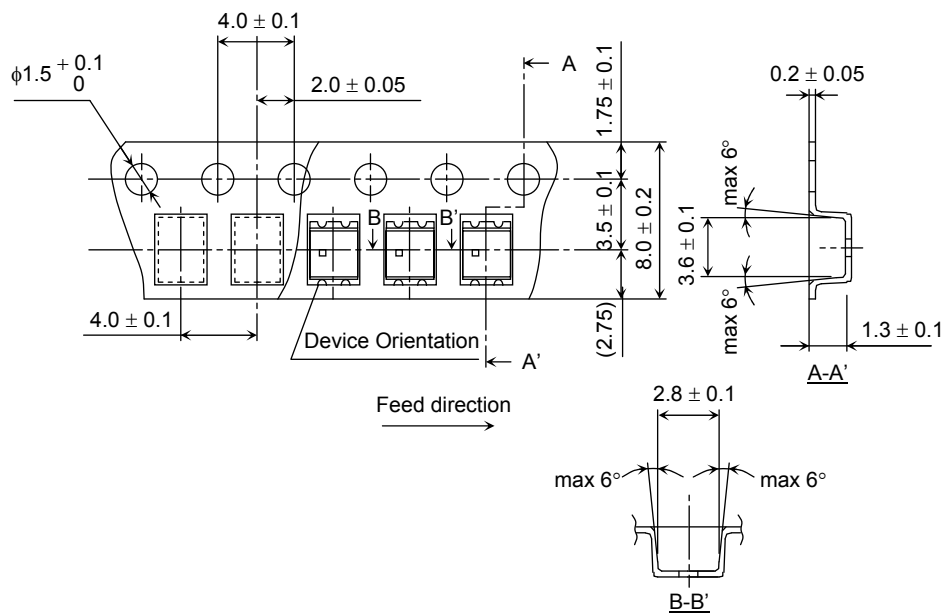

(3) Packing quantity: 3000/reel

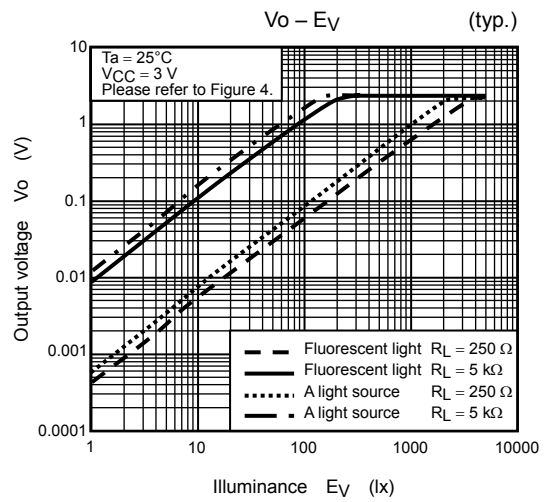
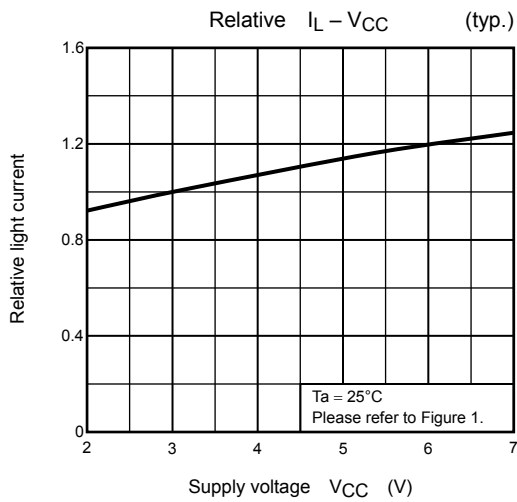
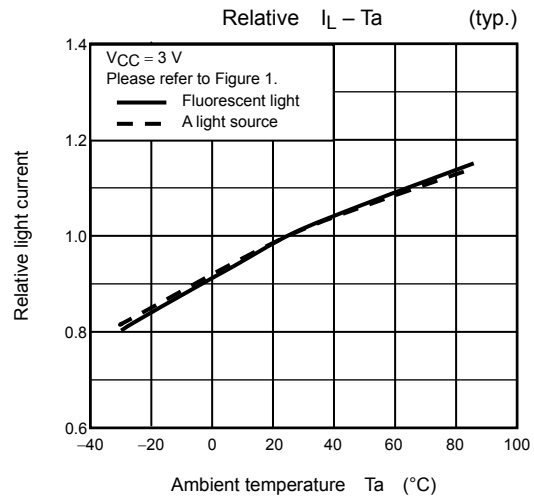
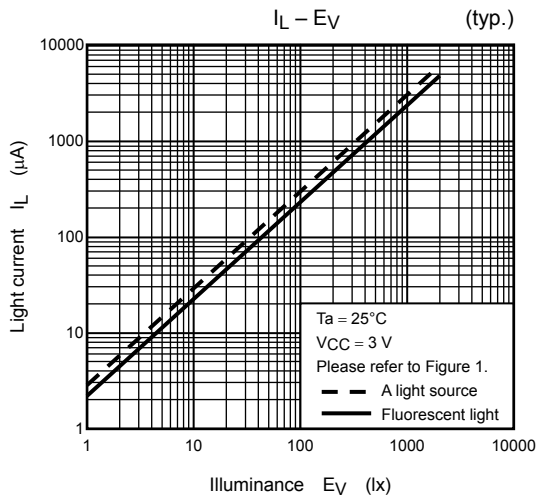
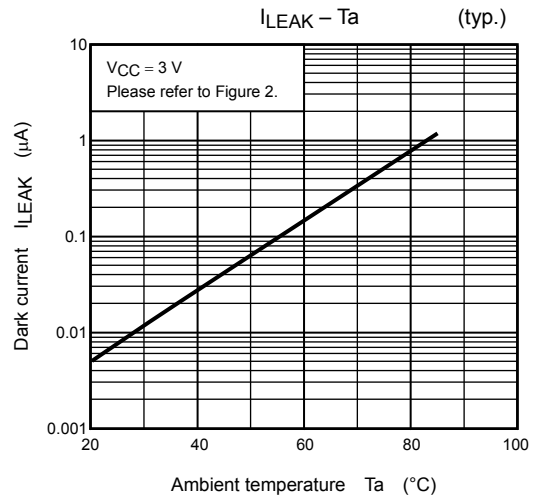
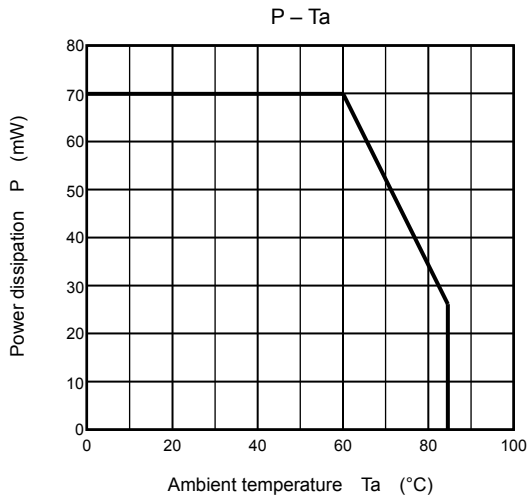

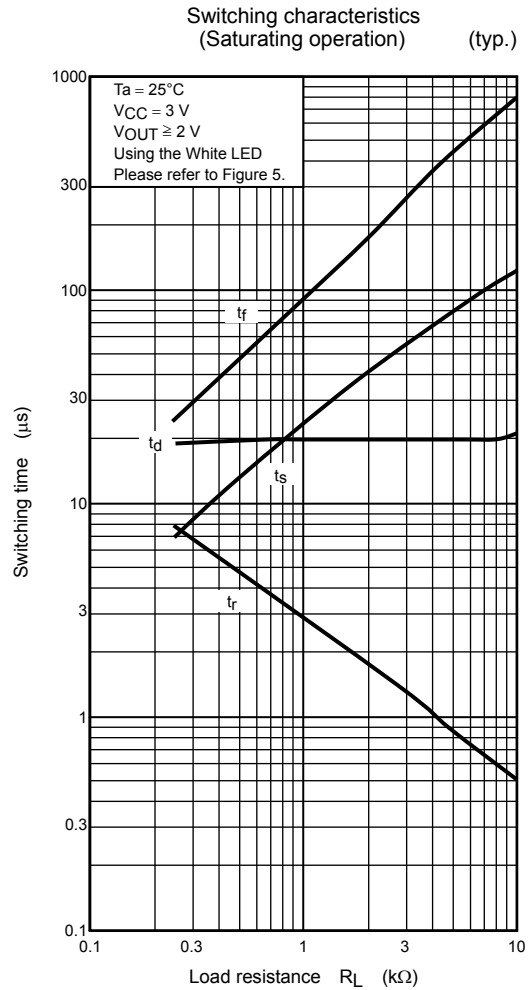
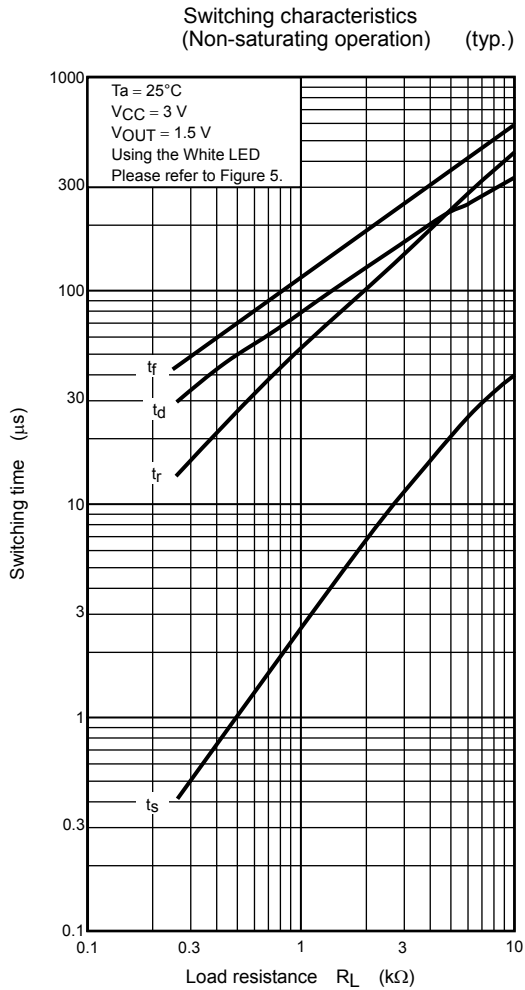
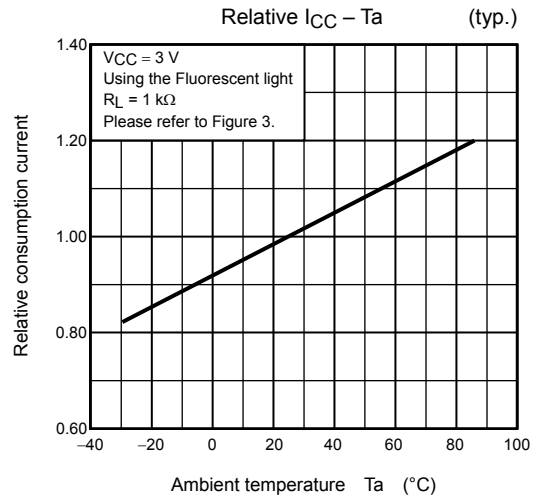
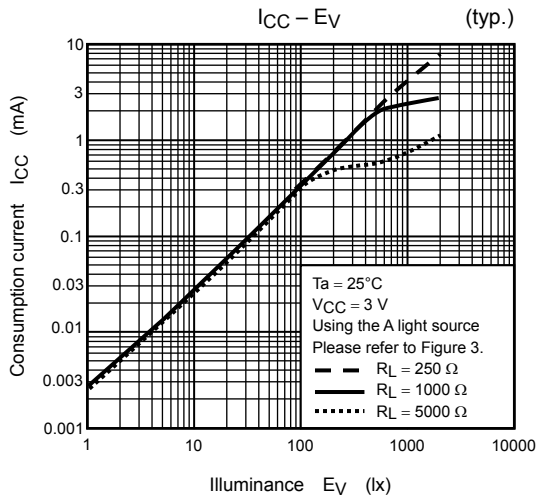

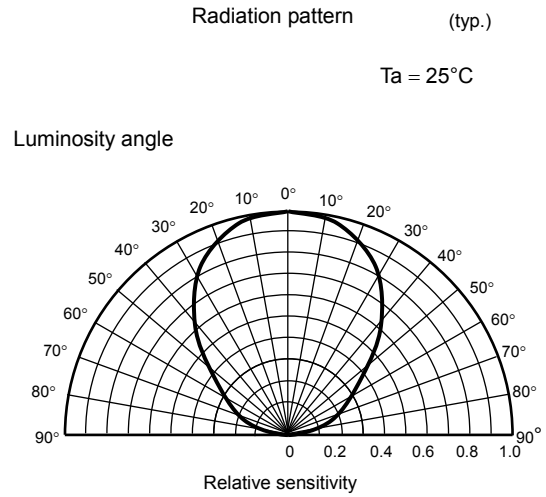
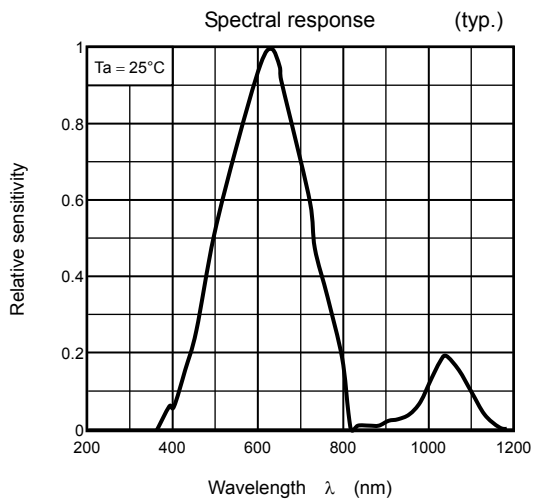

Measurement Circuits

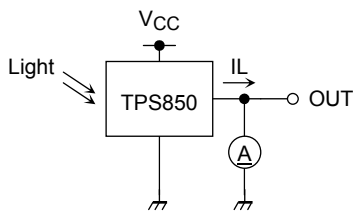

Figure 1 Light current measurement circuit

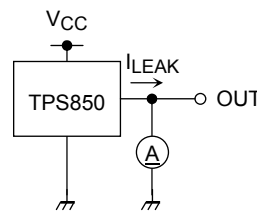

Figure 2 Dark current measurement circuit

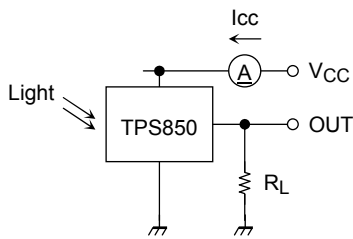

Figure 3 Consumption current measurement circuit

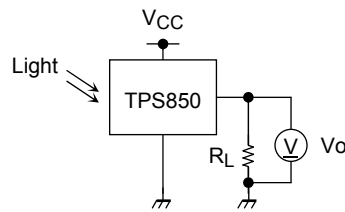

Figure 4 Output voltage measurement circuit

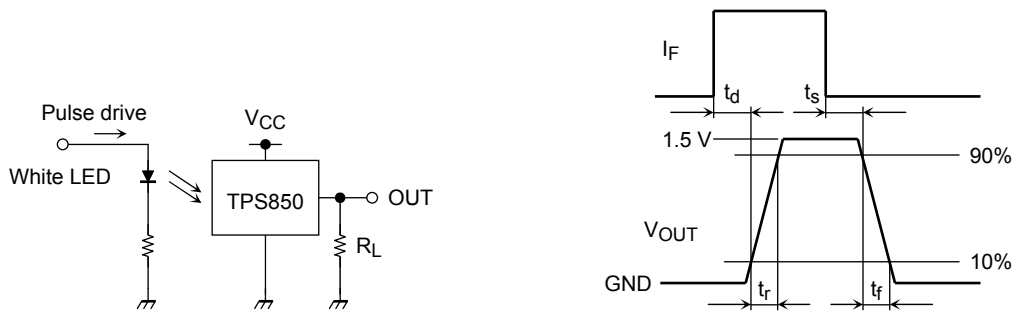

Figure 5 Switching measurement circuit and waveform

RESTRICTIONS ON PRODUCT USE

20070701-EN GENERAL

- The information contained herein is subject to change without notice.
- TOSHIBA is continually working to improve the quality and reliability of its products. Nevertheless, semiconductor devices in general can malfunction or fail due to their inherent electrical sensitivity and vulnerability to physical stress. It is the responsibility of the buyer, when utilizing TOSHIBA products, to comply with the standards of safety in making a safe design for the entire system, and to avoid situations in which a malfunction or failure of such TOSHIBA products could cause loss of human life, bodily injury or damage to property.
In developing your designs, please ensure that TOSHIBA products are used within specified operating ranges as set forth in the most recent TOSHIBA products specifications. Also, please keep in mind the precautions and conditions set forth in the "Handling Guide for Semiconductor Devices," or "TOSHIBA Semiconductor Reliability Handbook" etc.
- The TOSHIBA products listed in this document are intended for usage in general electronics applications (computer, personal equipment, office equipment, measuring equipment, industrial robotics, domestic appliances, etc.). These TOSHIBA products are neither intended nor warranted for usage in equipment that requires extraordinarily high quality and/or reliability or a malfunction or failure of which may cause loss of human life or bodily injury ("Unintended Usage"). Unintended Usage include atomic energy control instruments, airplane or spaceship instruments, transportation instruments, traffic signal instruments, combustion control instruments, medical instruments, all types of safety devices, etc.. Unintended Usage of TOSHIBA products listed in this document shall be made at the customer's own risk.
- The products described in this document shall not be used or embedded to any downstream products of which manufacture, use and/or sale are prohibited under any applicable laws and regulations.
- The information contained herein is presented only as a guide for the applications of our products. No responsibility is assumed by TOSHIBA for any infringements of patents or other rights of the third parties which may result from its use. No license is granted by implication or otherwise under any patents or other rights of TOSHIBA or the third parties.
- Please contact your sales representative for product-by-product details in this document regarding RoHS compatibility. Please use these products in this document in compliance with all applicable laws and regulations that regulate the inclusion or use of controlled substances. Toshiba assumes no liability for damage or losses occurring as a result of noncompliance with applicable laws and regulations.