

**AsahiKASEI**  
ASAHI KASEI EMD

**AKD4382A-SB**  
**AK4382A Evaluation board Rev.0**

### General Description

The AKD4382A-SB is an evaluation board for AK4382A, which is 192kHz sampling 24Bit  $\Delta\Sigma$  DAC. The AKD4382A-SB includes a LPF which can add differential analog outputs from the AK4382A and also has a digital interface. Therefore, it is easy to evaluate the AK4382A.

### Ordering Guide

AKD4382A-SB --- Evaluation board for AK4382A

### Function

- On-board Analog output buffer circuit
- On-board digital audio interface. (AK4113)

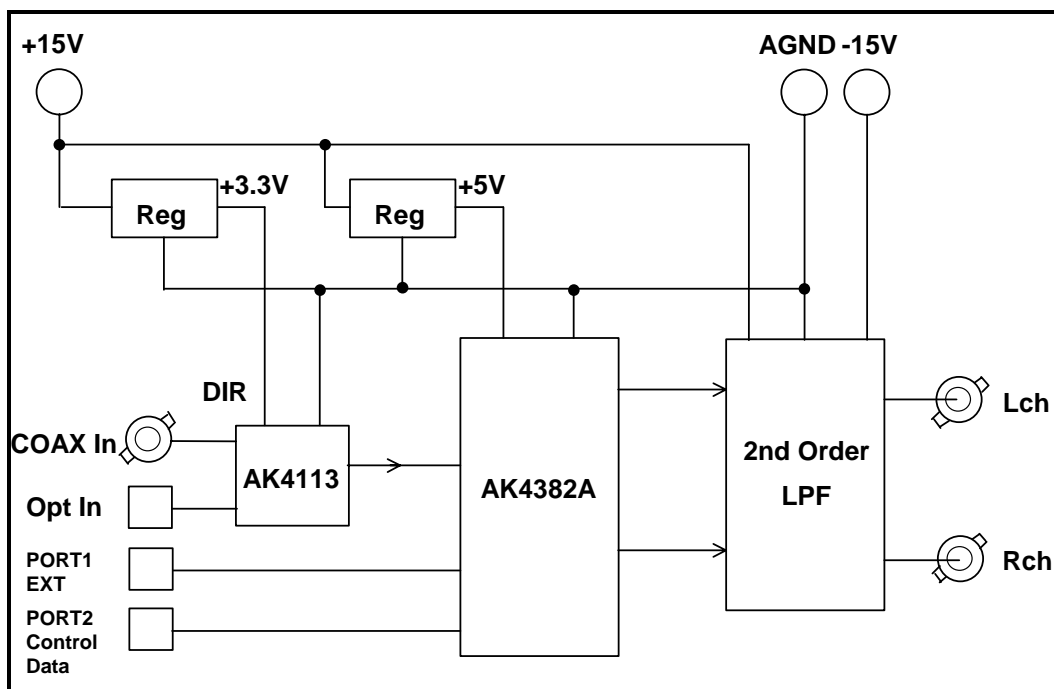


Figure 1. Block diagram

\* Circuit diagram are attached at the end of this manual.

COAX is recommended for an evaluation of the Sound quality.

## ■ Operation sequence

1) Set up the power supply lines. (See “Other jumpers set-up”.)

Name	Color	Voltage	Comments	Attention
+15V	Red	+12~+15V	For regulator and op-amps.	This jack should be always connected to power supply.
-15V	Blue	-12~-15V	For op-amps.	This jack should be always connected to power supply.
AGND	Black	0V	GND	This jack should be always connected to power supply.

Table 1. Set up of power supply lines

Each supply line should be distributed from the power supply unit.

2) Set-up the jumper pins

3) Set-up the DIP switches. (See the followings.)

4) Power on

The AK4382A should be reset once by bringing SW1 (PDN) “L” upon power-up.

## ■ Evaluation mode

### 1. DIR (COAX) (default)

It is possible to evaluate the AK4382A by using CD disk. The DIR generates MCLK, BICK, LRCK and SDATA from the received data through BNC connector (J1). Setting of jumper is shown below.

COAX is recommended for an evaluation of the Sound quality.

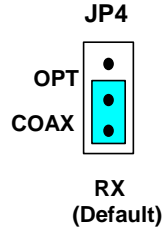


Figure 2. Jumper setting, when using DIR

### 2. DIR (Optical Link)

It is possible to evaluate the AK4382A by using CD disk. The DIR generates MCLK, BICK, LRCK and SDATA from the received data through optical connector (PORT3: TORX176). Setting of jumper is shown below.

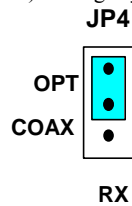


Figure 3. Jumper setting, when using DIR

### 3. All clocks are fed through the PORT1.

R13, R15, R17, R18 : open  
R1, R2, R3, R8 : 100Ω or short (0Ω)

## ■ DIP Switch setting

[SW2]: AK4113 setting

No.	Pin	OFF	ON	Default
1	OCKS1	AK4113 Master Clock setting Refer to Table4		ON
2	OCKS0			OFF

Table 2. SW2 setting

The frequency of the master clock output is set by OCKS0 and OCKS1 as shown in Table 4.

OCKS1	OCKS0	MCLK Frequency
0	0	256fs @fs=88.2/96kHz
1	0	512fs @32/44.1/48kHz
1	1	128fs @176.4/192kHz

Default

Table 3. MCLK Clock

## ■ SW1 setting

[SW1](PDN): Reset of AK4382A. Select “H” during operation.

## ■ External Analog Filter Circuit

The 2nd order LPF ( $f_c=93.2\text{kHz}$ ,  $Q=0.712$ ) which adds differential outputs of the AK4382A is implemented on the board. When the further attenuation of the out-of-band noise is needed, some additional LPF is required. Analog signal is output through BNC connectors on the board. And the output level of the AK4382A is  $5.5\text{Vpp}@5\text{V}$ .

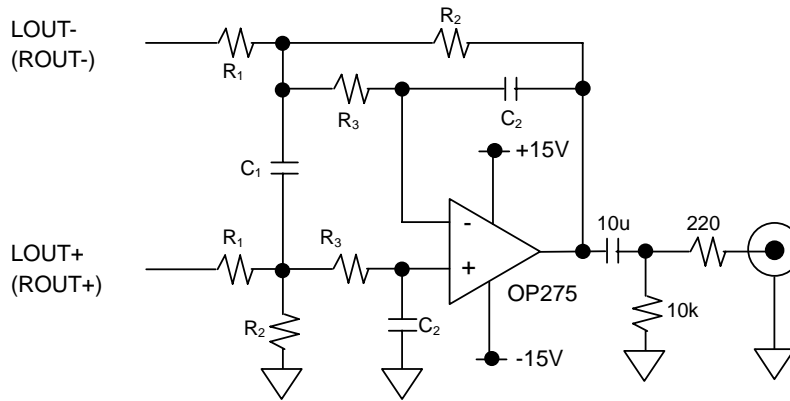


Figure 4. On-board analog filter

$R_1$	$R_2$	$R_3$	$C_1$	$C_2$
4.7k	4.7k	200	3900p	470p

Table 4. The value of R, C on this board

$f_{in}$	20kHz	40kHz	80kHz
Frequency Response	-0.003dB	-0.122dB	-1.821dB

Table 5. Frequency Response of LPF

<Calculation>

$$\text{Amplitude} = 20 \log \frac{K}{\sqrt{[1-(f/f_c)^2]^2 + [(1/Q)(f/f_c)]^2}} \text{ [dB]},$$

$$K = \frac{R_2}{R_1},$$

$$f_c = \frac{\omega_0}{2\pi},$$

$$\omega_0 = \frac{1}{\sqrt{2C_1C_2R_2R_3}},$$

$$Q = \frac{2C_1\omega_0}{\frac{1}{R_1} + \frac{1}{R_2} + \frac{1}{R_3}}.$$

## Control Software Manual

### ■ Set-up of evaluation board and control software

1. Set up the AKD4382A-SB according to previous term.
2. Connect IBM-AT compatible PC with AKD4382A-SB by 10-line type flat cable (packed with AKD4382A-SB). Take care of the direction of 10pin header. (Please install the driver in the CD-ROM when this control software is used on Windows 2000/XP. Please refer "Installation Manual of Control Software Driver by AKM device control software". In case of Windows95/98/ME, this installation is not needed. This control software does not operate on Windows NT.)
3. Insert the CD-ROM labeled "AKD4382A-SB Evaluation Kit" into the CD-ROM drive.
4. Access the CD-ROM drive and double-click the icon of "AKD4382A-SB.exe" to set up the control program.
5. Then please evaluate according to the follows.

### ■ Operation flow

Keep the following flow.

1. Set up the control program according to explanation above.
2. Click "Port Reset" button.

### ■ Explanation of each buttons

- |                      |   |
|----------------------|---|
| 1. [Port Reset] :    | Set up the USB interface board (AKDUSBIF-A) in case using the board.  |
| 2. [Write default] : | Initialize the register of AK4382A.   |
| 3. [All Write] :     | Write all registers that is currently displayed.  |
| 4. [Function1] :     | Dialog to write data by keyboard operation.   |
| 5. [Function2] :     | Dialog to write data by keyboard operation.   |
| 6. [Function3] :     | The sequence of register setting can be set and executed.   |
| 7. [Function4] :     | The sequence that is created on [Function3] can be assigned to buttons and executed.                            |
| 8. [Function5]:      | The register setting that is created by [SAVE] function on main window can be assigned to buttons and executed. |
| 9. [SAVE] :          | Save the current register setting.  |
| 10. [OPEN] :         | Write the saved values to all register.   |
| 11. [Write] :        | Dialog to write data by mouse operation.  |

### ■ Indication of data

Input data is indicated on the register map. Red letter indicates "H" or "1" and blue one indicates "L" or "0". Blank is the part that is not defined in the datasheet.



#### 4. [Save] and [Open]

##### 4-1. [Save]

Save the current register setting data. The extension of file name is “akr”.

(Operation flow)

- (1) Click [Save] Button.
- (2) Set the file name and push [Save] Button. The extension of file name is “akr”.

##### 4-2. [Open]

The register setting data saved by [Save] is written to AK4382A. The file type is the same as [Save].

(Operation flow)

- (1) Click [Open] Button.
- (2) Select the file (\*.akr) and Click [Open] Button.

## 5. [Function3 Dialog]

The sequence of register setting can be set and executed.

(1) Click [F3] Button.

(2) Set the control sequence.

Set the address, Data and Interval time. Set “-1” to the address of the step where the sequence should be paused.

(3) Click [Start] button. Then this sequence is executed.

The sequence is paused at the step of Interval="-1". Click [START] button, the sequence restarts from the paused step.

This sequence can be saved and opened by [Save] and [Open] button on the Function3 window. The extension of file name is “aks”.

The screenshot shows a window titled "Function3" with a table of 25 steps. Each step has three columns: Address, Data, and Interval. The Address column contains "-1", the Data column contains "0", and the Interval column contains "ms". The steps are numbered 1 through 25. Below the table, there is a "Start Step" field with the value "1", a "START" button, a "Help" button, a "Save" button, an "OPEN" button, and a "Close" button.

	Address	Data	Interval	Address	Data	Interval
1	-1	0	ms	16	-1	0
2	-1	0	ms	17	-1	0
3	-1	0	ms	18	-1	0
4	-1	0	ms	19	-1	0
5	-1	0	ms	20	-1	0
6	-1	0	ms	21	-1	0
7	-1	0	ms	22	-1	0
8	-1	0	ms	23	-1	0
9	-1	0	ms	24	-1	0
10	-1	0	ms	25	-1	0
11	-1	0	ms			
12	-1	0	ms			
13	-1	0	ms			
14	-1	0	ms			
15	-1	0	ms			

Start Step: 1

Buttons: START, Help, Save, OPEN, Close

Figure 5. Window of [F3]



### 6. [Function4 Dialog]

The sequence that is created on [Function3] can be assigned to buttons and executed. When [F4] button is clicked, the window as shown in Figure 6 opens.

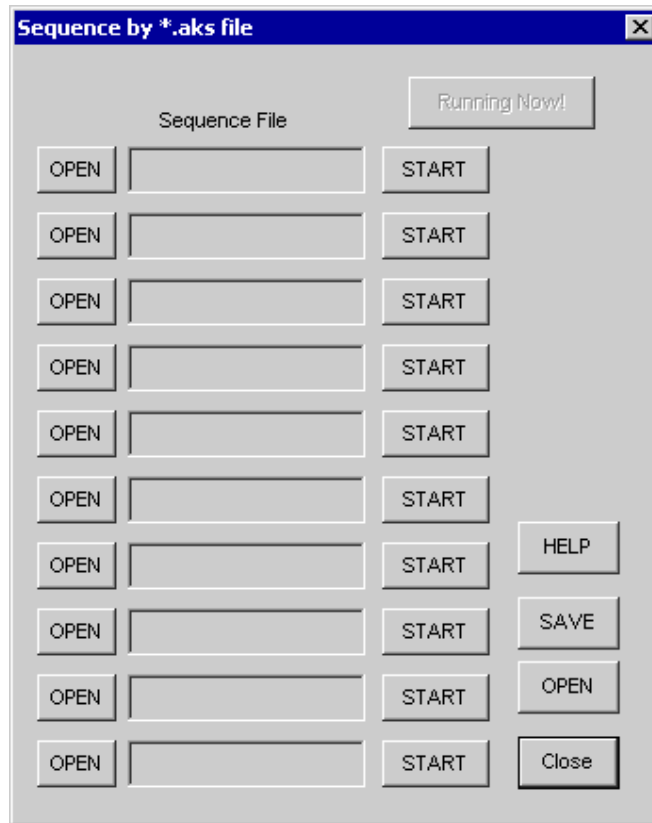


Figure 6. [F4] window

### 6-1. [OPEN] buttons on left side and [START] buttons

(1) Click [OPEN] button and select the sequence file (\*.aks).

The sequence file name is displayed as shown in Figure 7.

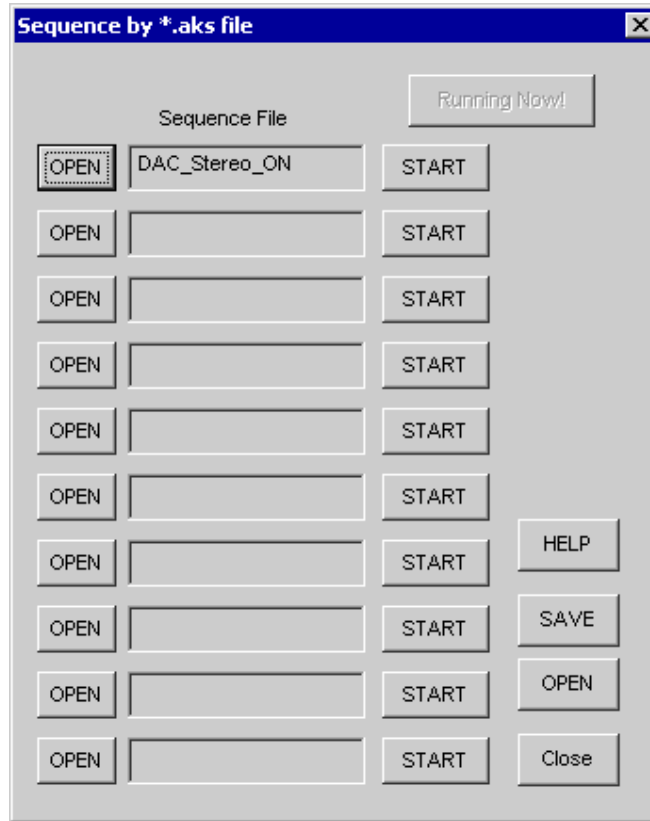


Figure 7. [F4] window (2)

(2) Click [START] button, then the sequence is executed.

### 6-2. [SAVE] and [OPEN] buttons on right side

[SAVE] : The sequence file names can assign be saved. The file name is \*.ak4.

[OPEN] : The sequence file names assign that are saved in \*.ak4 are loaded.

### 6-3. Note

(1) This function doesn't support the pause function of sequence function.

(2) All files need to be in same folder used by [SAVE] and [OPEN] function on right side.

(3) When the sequence is changed in [Function3], the file should be loaded again in order to reflect the change.

## 7. [Function5 Dialog]

The register setting that is created by [SAVE] function on main window can be assigned to buttons and executed. When [F5] button is clicked, the following window as shown in Figure 8 opens.

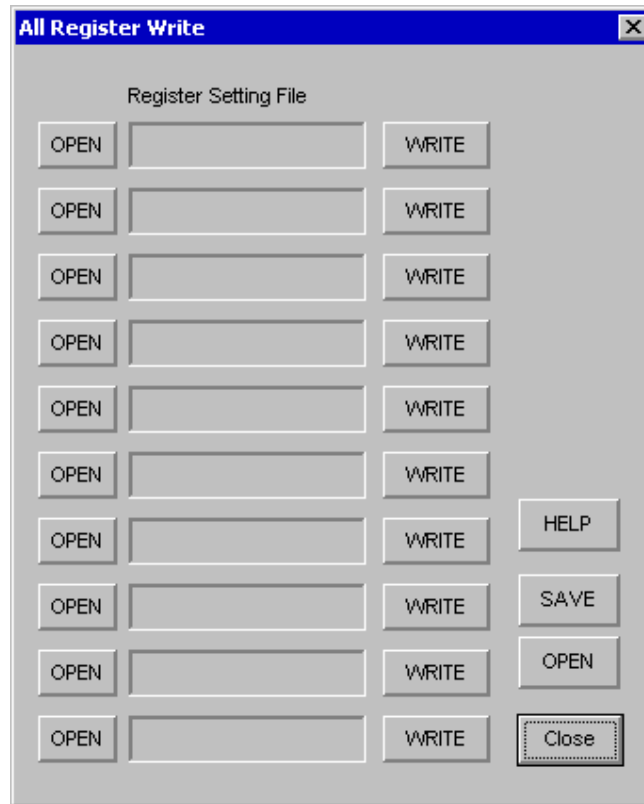


Figure 8. [F5] window

### 7-1. [OPEN] buttons on left side and [WRITE] button

- (1) Click [OPEN] button and select the register setting file (\*.akr).
- (2) Click [WRITE] button, then the register setting is executed.

### 7-2. [SAVE] and [OPEN] buttons on right side

[SAVE] : The register setting file names assign can be saved. The file name is \*.ak5.

[OPEN] : The register setting file names assign that are saved in \*.ak5 are loaded.

### 7-3. Note

- (1) All files need to be in same folder used by [SAVE] and [OPEN] function on right side.
- (2) When the register setting is changed by [Save] Button in main window, the file should be loaded again in order to reflect the change.

<b>Measurement Results</b>
----------------------------

## [Measurement condition]

- Measurement unit : Audio Precision System two Cascade (AP2)
- MCLK : 512fs (44.1kHz), 256fs (96kHz), 128fs (192kHz)
- BICK : 64fs
- fs : 44.1kHz, 96kHz, 192kHz
- Bit : 24bit
- Power Supply : VDD=5V
- Interface : Internal DIR (44.1kHz, 96kHz, 192kHz)
- Temperature : Room

fs=44.1kHz

Parameter	Input signal	Measurement filter	Lch	Rch
S/(N+D)	1kHz, 0dB	20kLPF	93.5 dB	94.1 dB
DR	1kHz, -60dB	22kLPF, A-weighted	112.5 dB	112.5 dB
S/N	"0" data	22kLPF, A-weighted	112.5 dB	112.4 dB

fs=96kHz

Parameter	Input signal	Measurement filter	Lch	Rch
S/(N+D)	1kHz, 0dB	40kLPF	92.1 dB	92.6 dB
DR	1kHz, -60dB	40kLPF	105.0 dB	104.9 dB
		22kLPF, A-weighted	112.6 dB	112.6 dB
S/N	"0" data	40kLPF	105.1 dB	105.0 dB
		22kLPF, A-weighted	112.9 dB	112.9 dB

fs=192kHz

Parameter	Input signal	Measurement filter	Lch	Rch
S/(N+D)	1kHz, 0dB	40kLPF	91.0 dB	91.5 dB
DR	1kHz, -60dB	40kLPF	104.3 dB	104.3 dB
		22kLPF, A-weighted	111.6 dB	111.6 dB
S/N	"0" data	40kLPF	105.0 dB	104.9 dB
		22kLPF, A-weighted	112.7 dB	112.6 dB

**Plots**

(fs=44.1kHz)

AKM

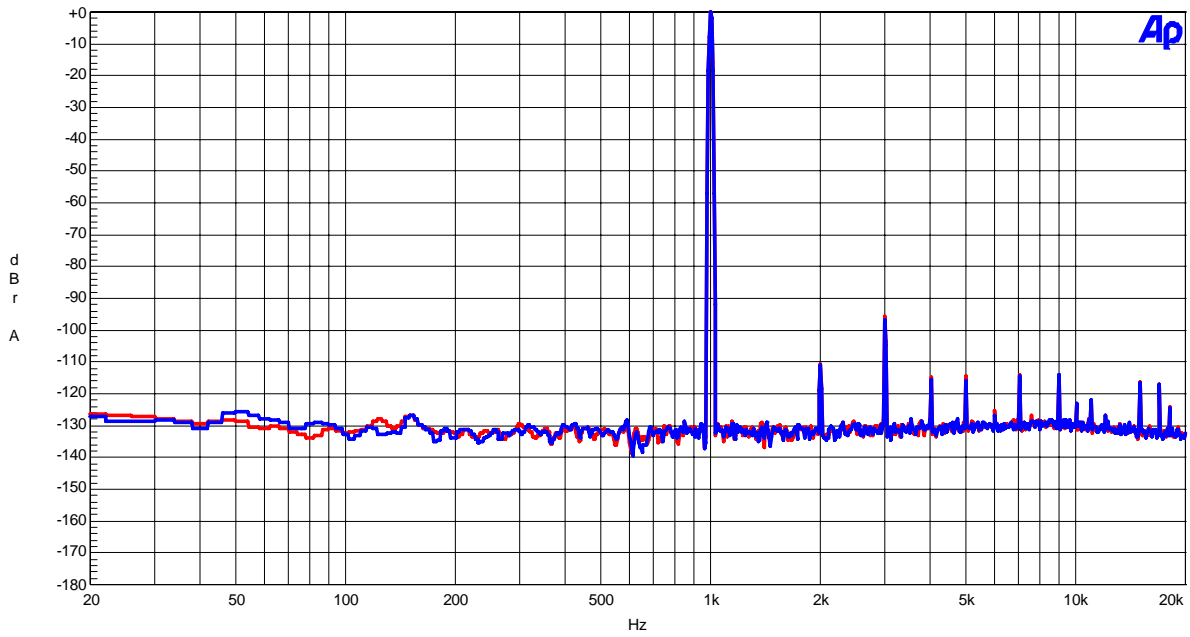
AK4382A FFT  
VDD=5V, fs=44.1kHz, fin=1kHz, 0dBFS input

Figure 9. FFT (fin=1kHz, 0dBFS input)

AKM

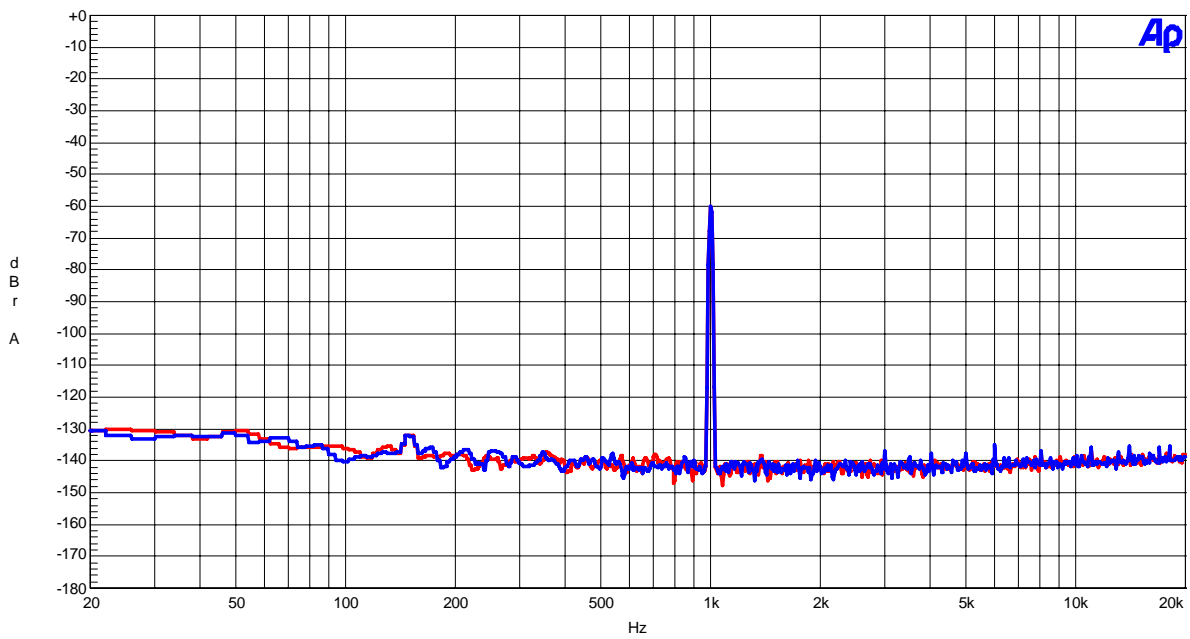
AK4382A FFT  
VDD=5V, fs=44.1kHz, fin=1kHz, -60dBFS input

Figure 10. FFT (fin=1kHz, -60dBFS input)

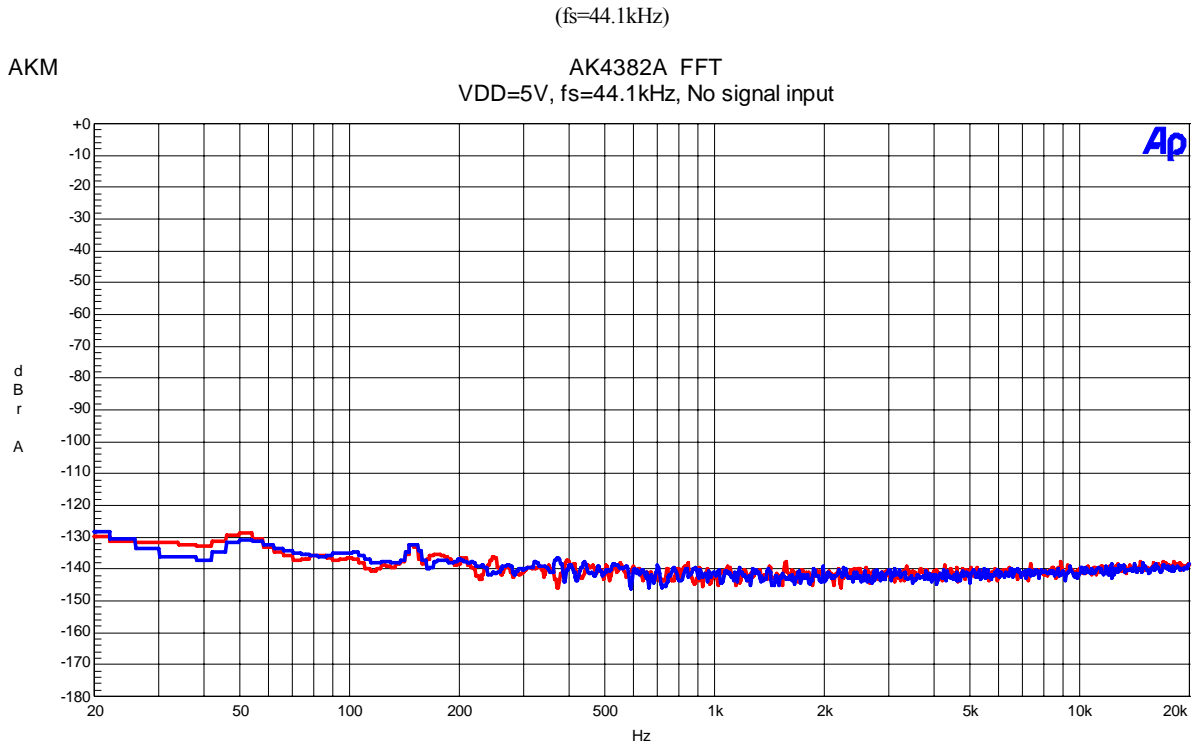


Figure 11. FFT (Noise Floor)

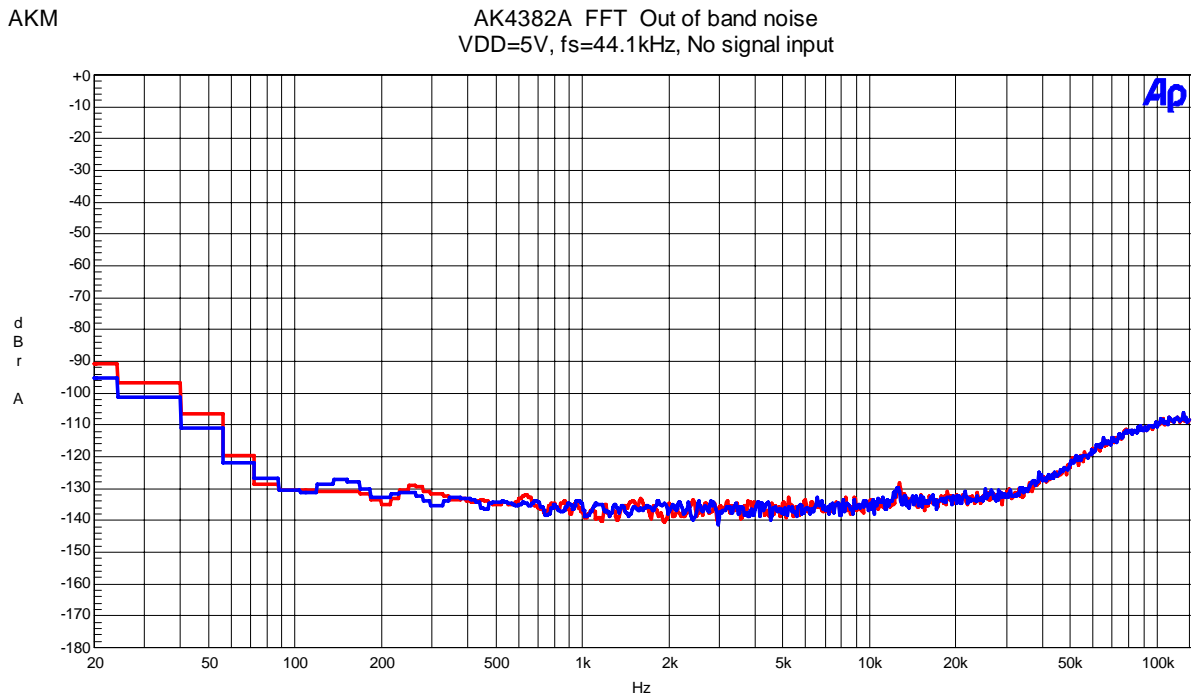


Figure 12. FFT (Out of band noise)

(fs=44.1kHz)

AKM

AK4382A THD+N vs. Input Level  
VDD=5V, fs=44.1kHz, fin=1kHz

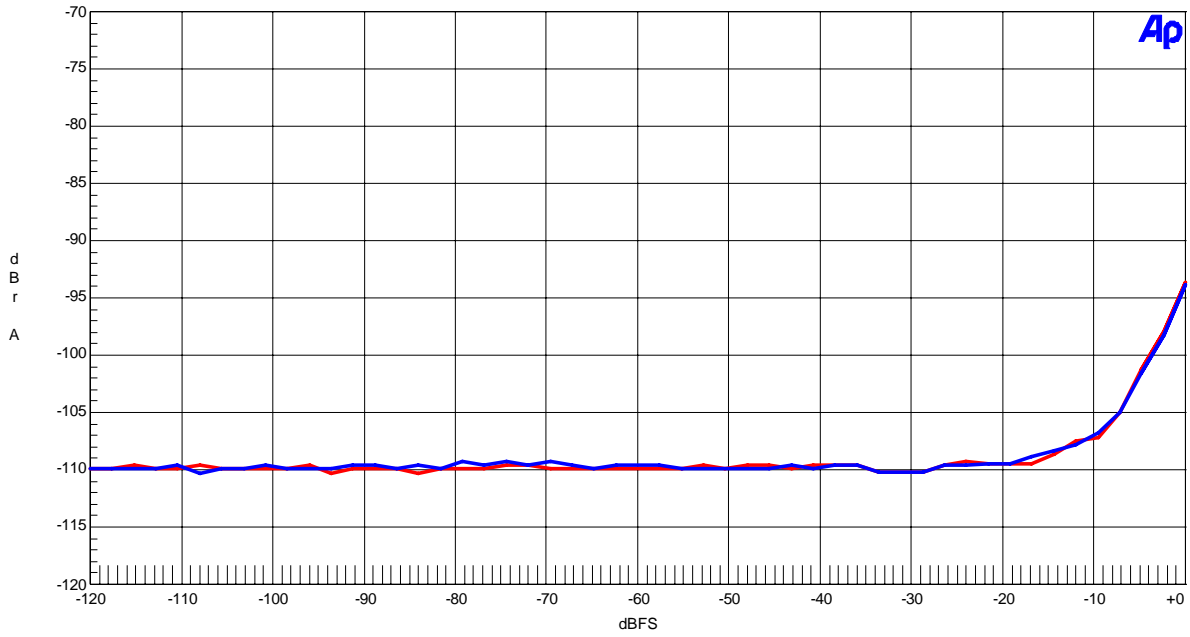


Figure 13 . THD+N vs. Input level (fin=1kHz)

AKM

AK4382A THD+N vs. Input Frequency  
VDD=5V, fs=44.1kHz, 0dBFS input

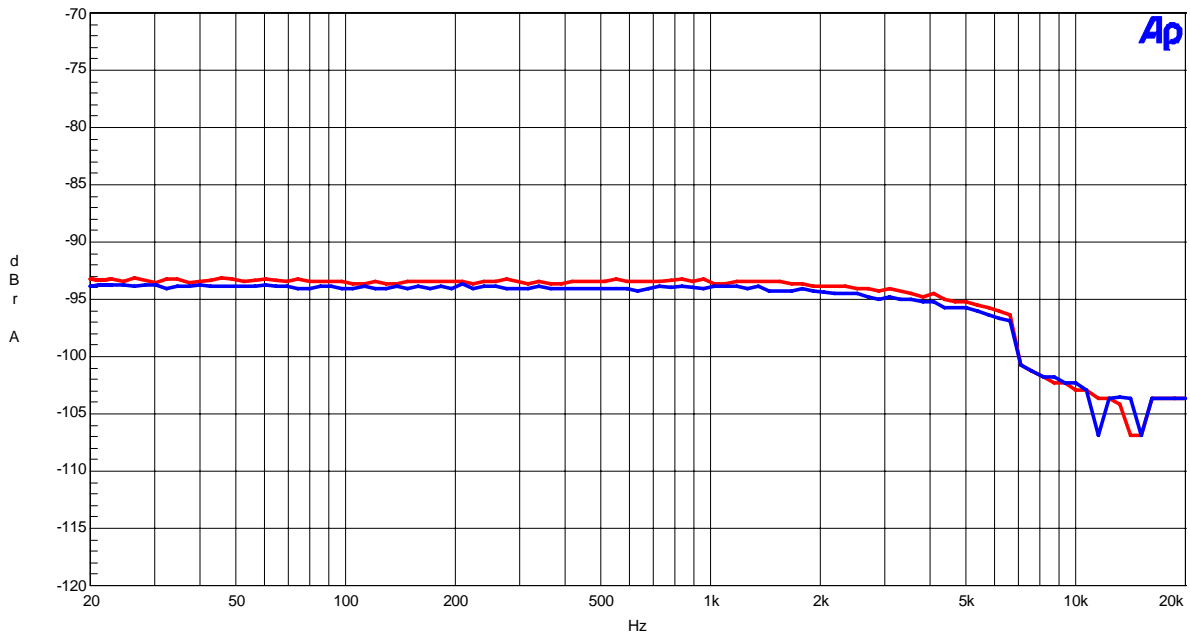


Figure 14 . THD+N vs. Input Frequency (0dBFS input)

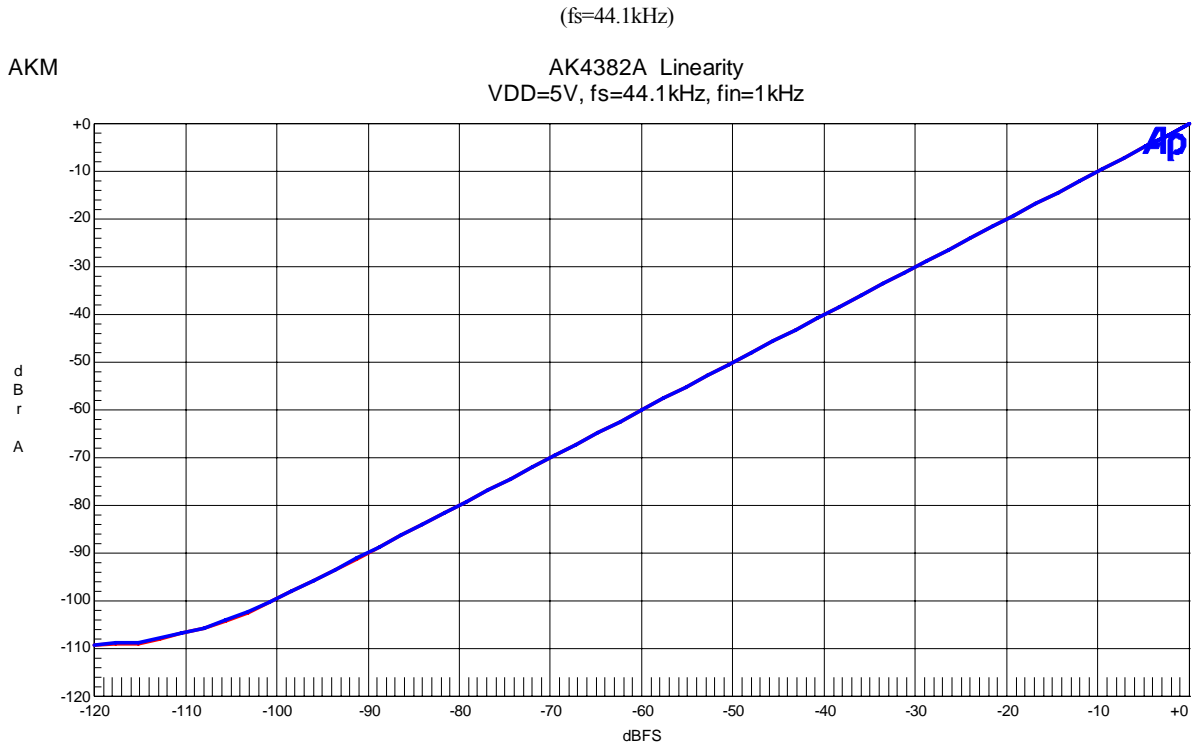


Figure 15. Linearity (fin=1kHz)

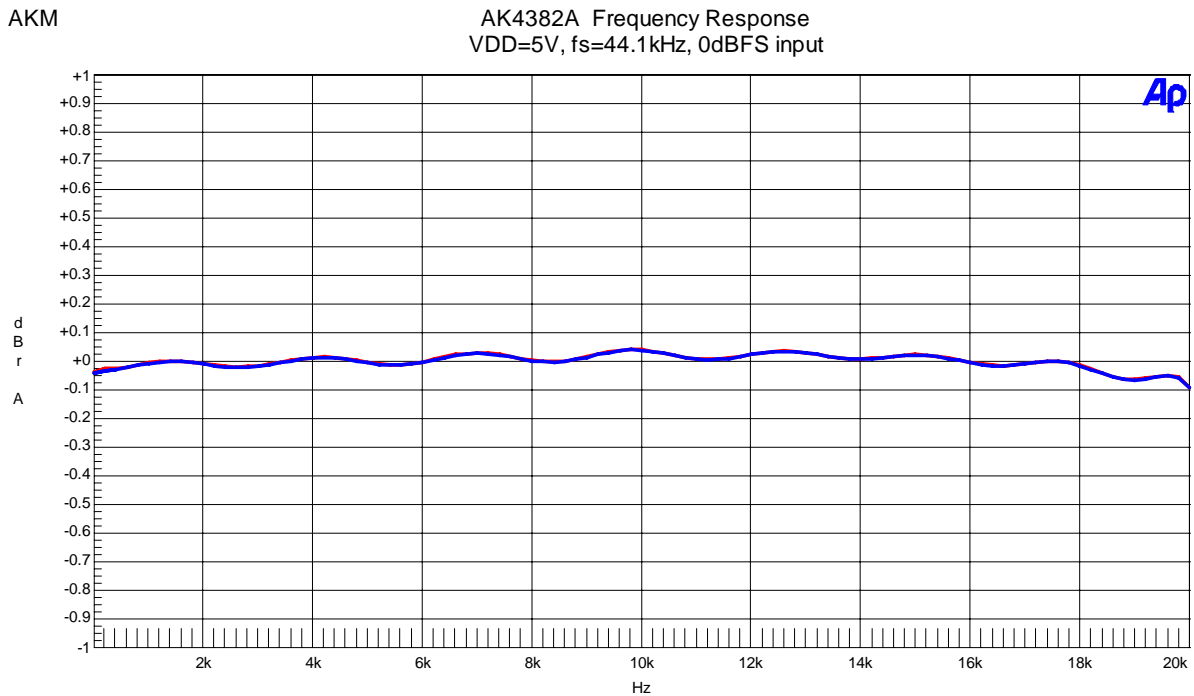


Figure 16. Frequency Response (0dBFS input)



(fs=44.1kHz)

AKM

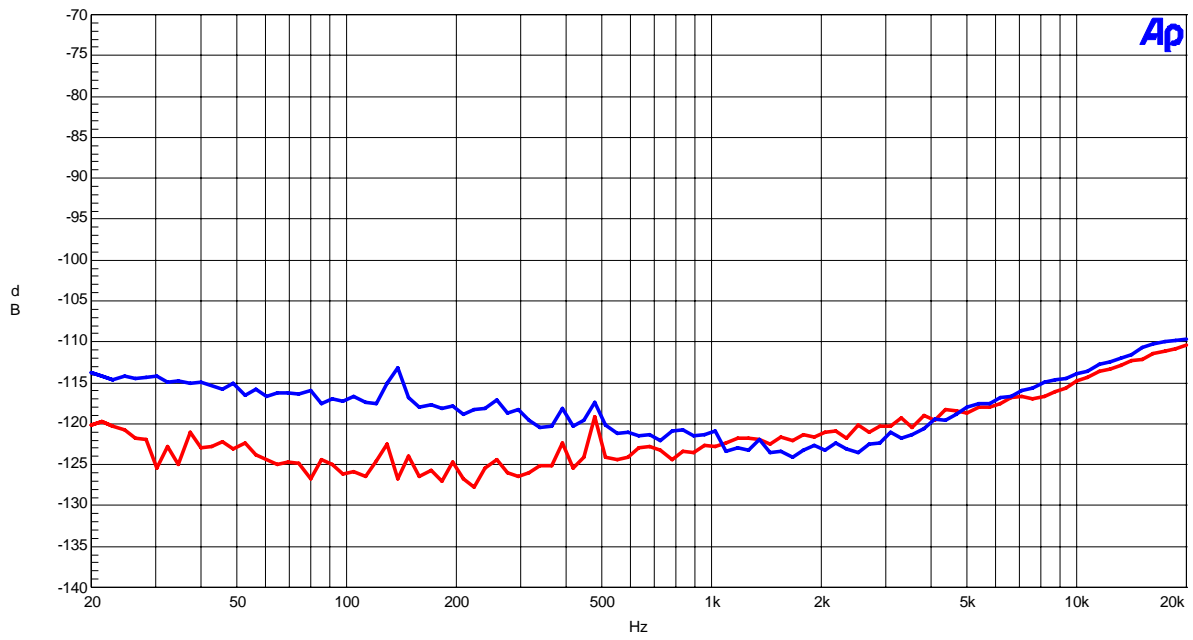
AK4382A Crosstalk (Red=Lch, Blue=Rch)  
VDD=5V, fs=44.1kHz, 0dBFS input

Figure 17. Crosstalk (0dBFS input)

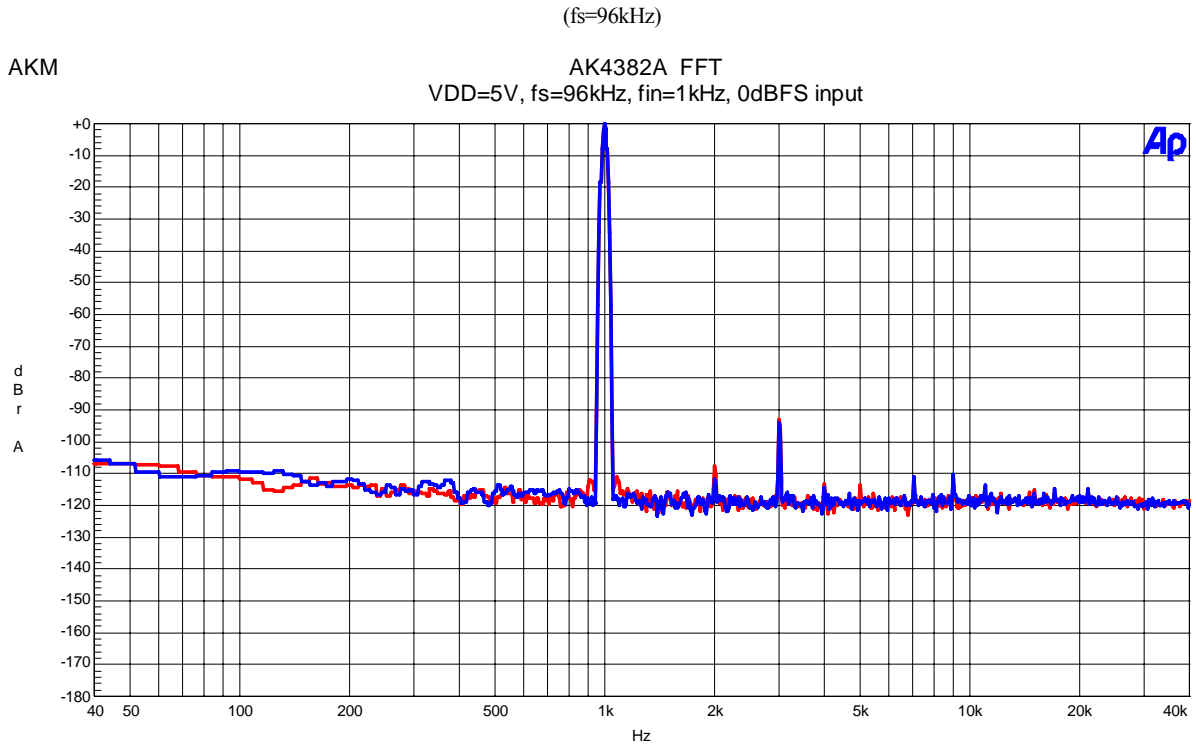


Figure 18. FFT (fin=1kHz, 0dBFS input)

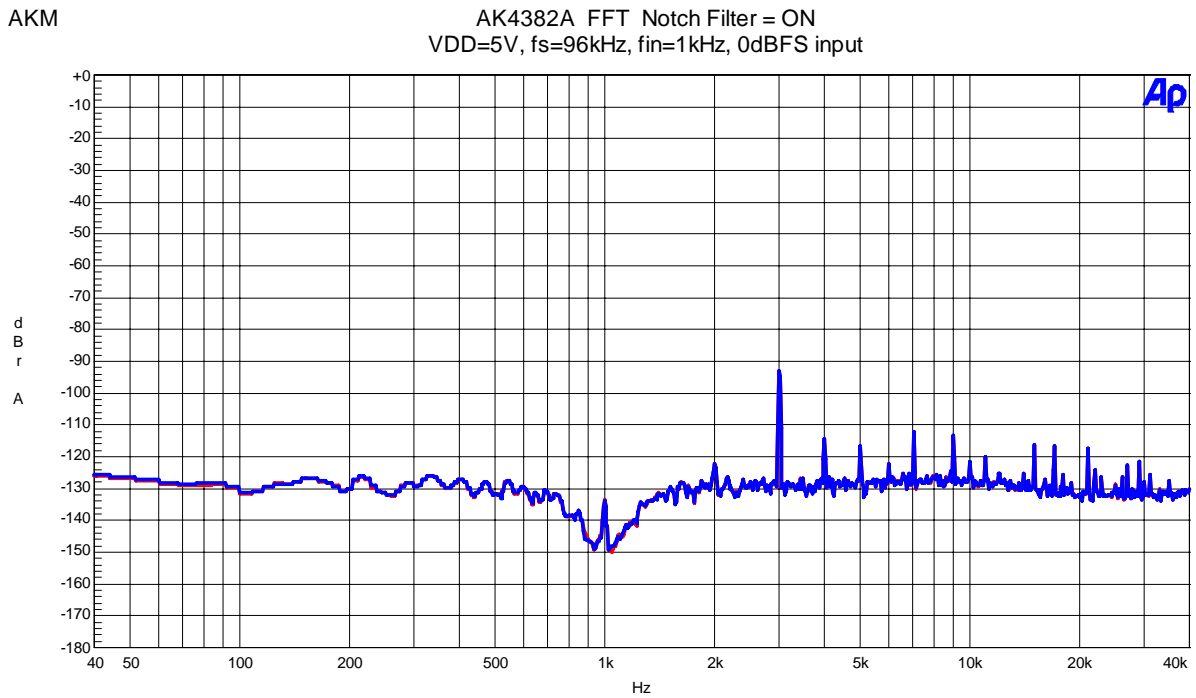


Figure 19. FFT(fin=1kHz, 0dBFS input, Notch)

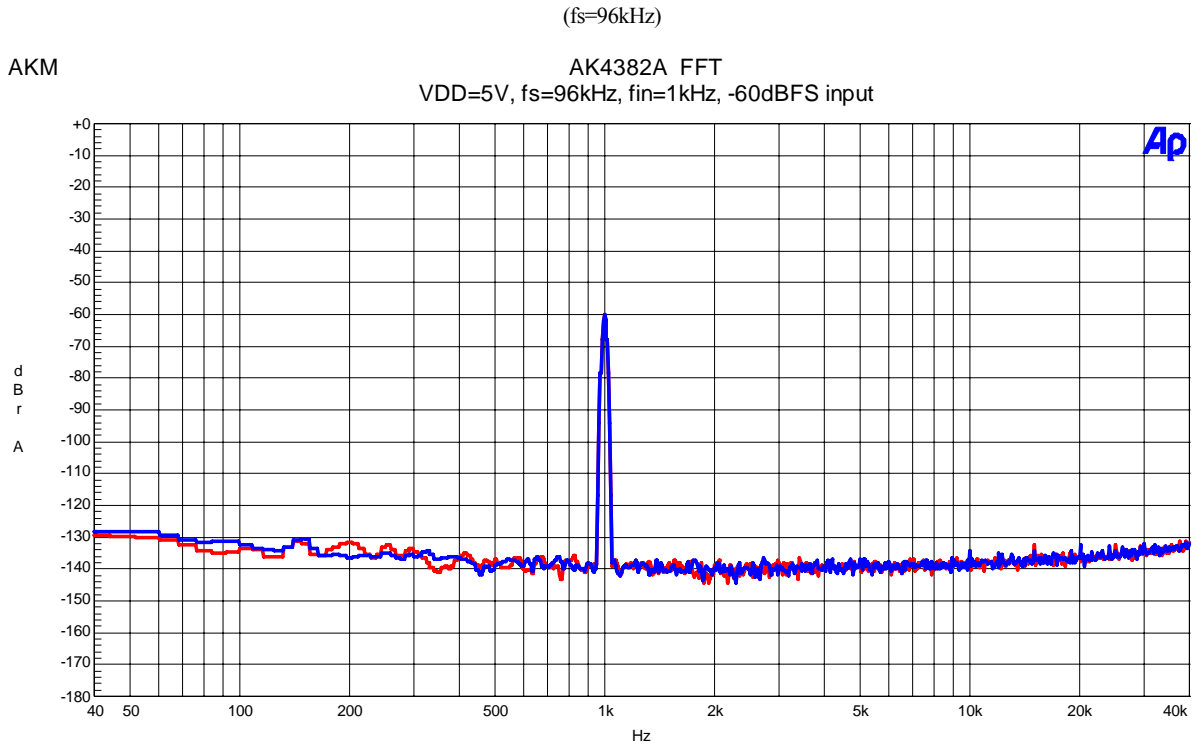


Figure 20. FFT (fin=1kHz, -60dBFS input)

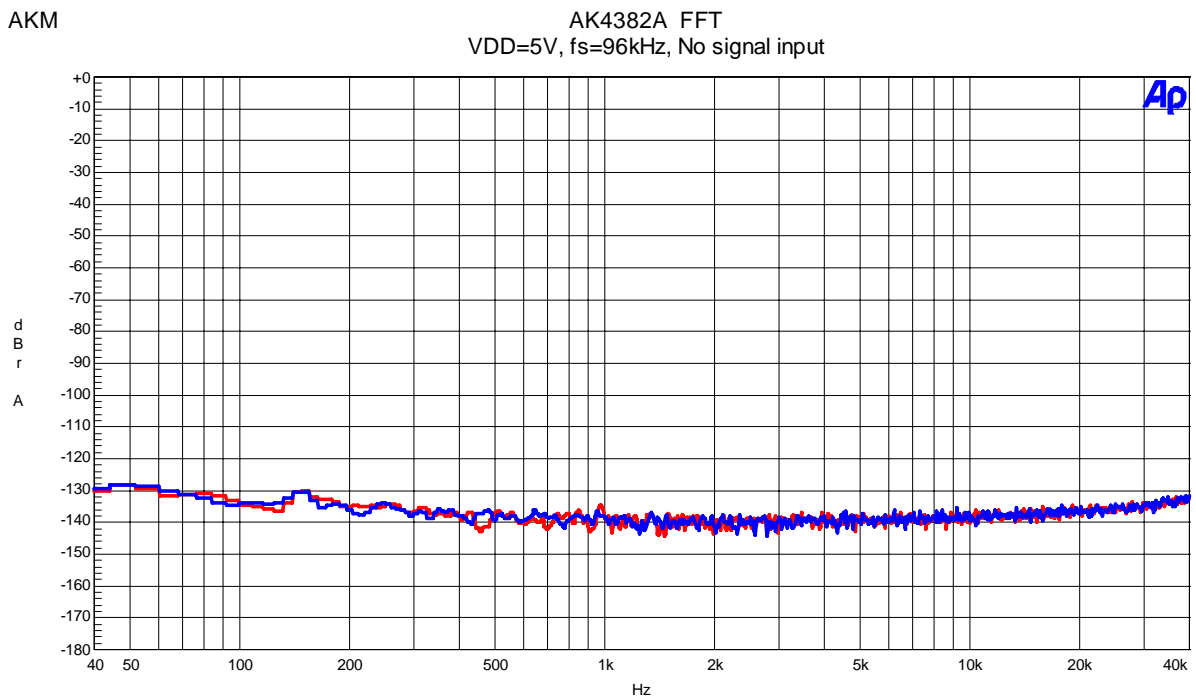


Figure 21. FFT (Noise Floor)

(fs=96kHz)

AKM

AK4382A THD+N vs. Input Level  
VDD=5V, fs=96kHz, fin=1kHz

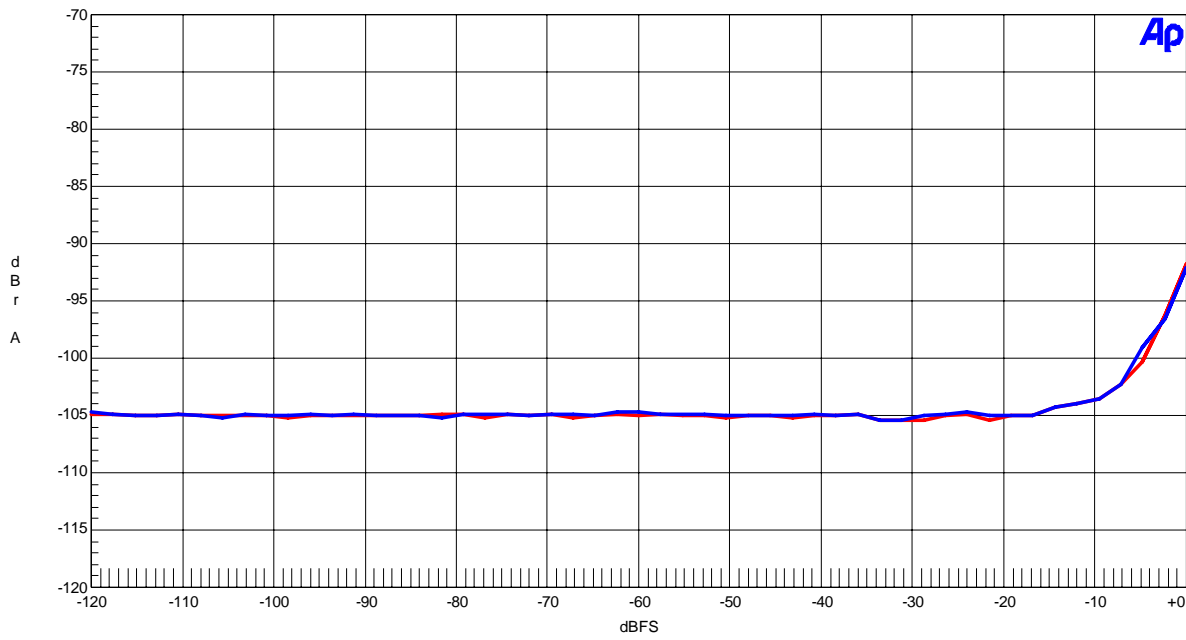


Figure 22. THD+N vs. Input level (fin=1kHz)

AKM

AK4382A THD+N vs. Input Frequency  
VDD=5V, fs=96kHz, 0dBFS input

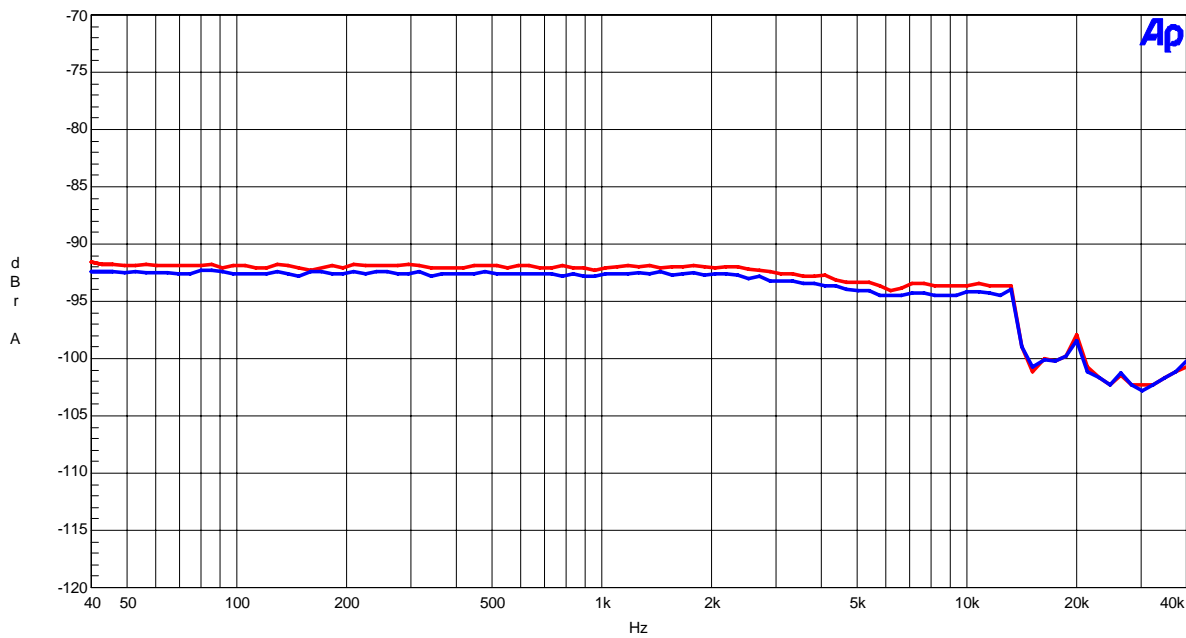


Figure 23. THD+N vs. Input Frequency (0dBFS input)

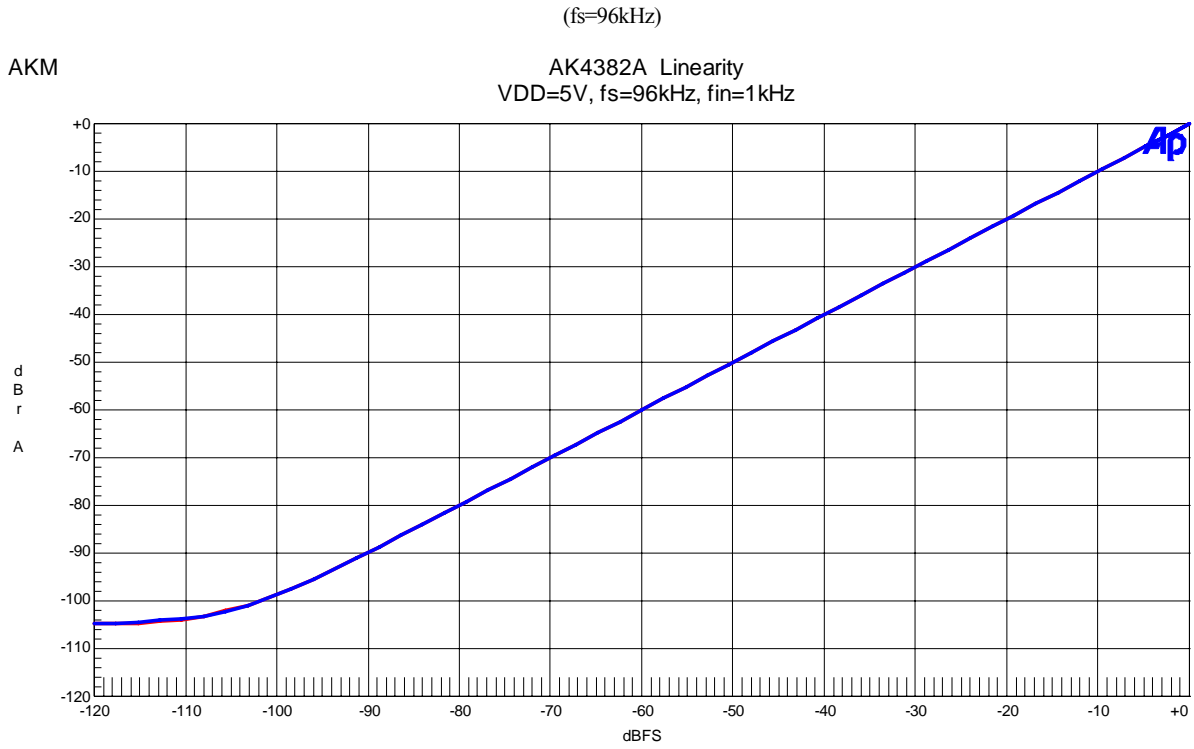


Figure 24. Linearity (fin=1kHz)

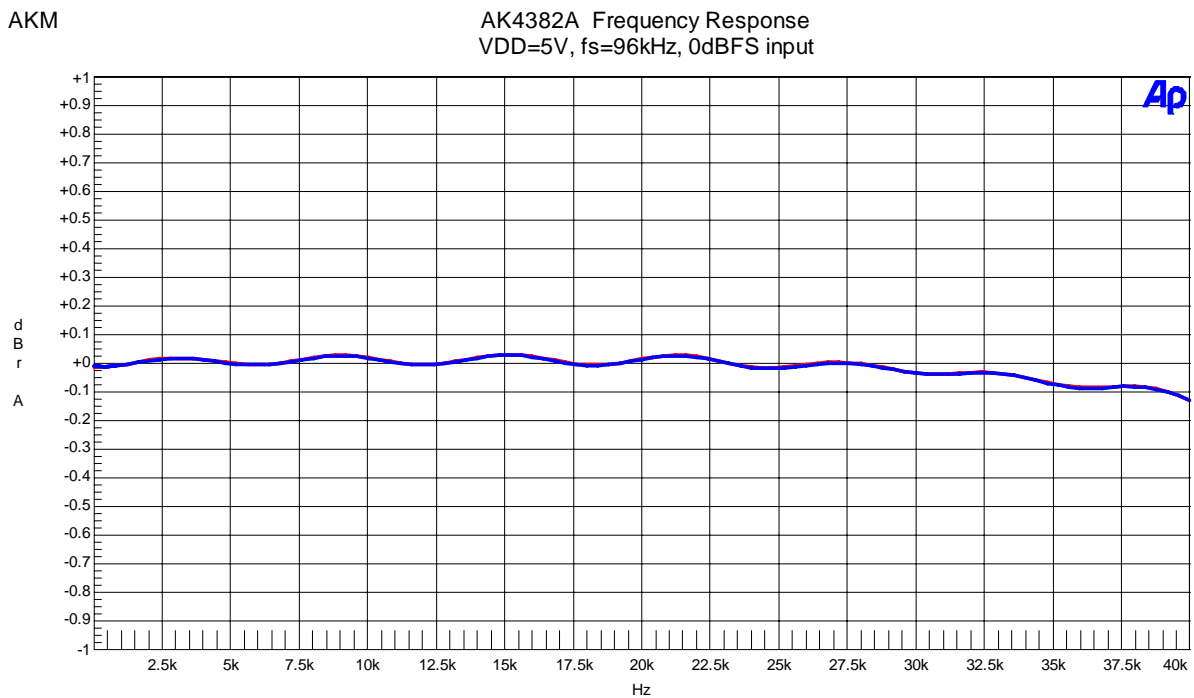


Figure 25. Frequency Response (0dBFS input)

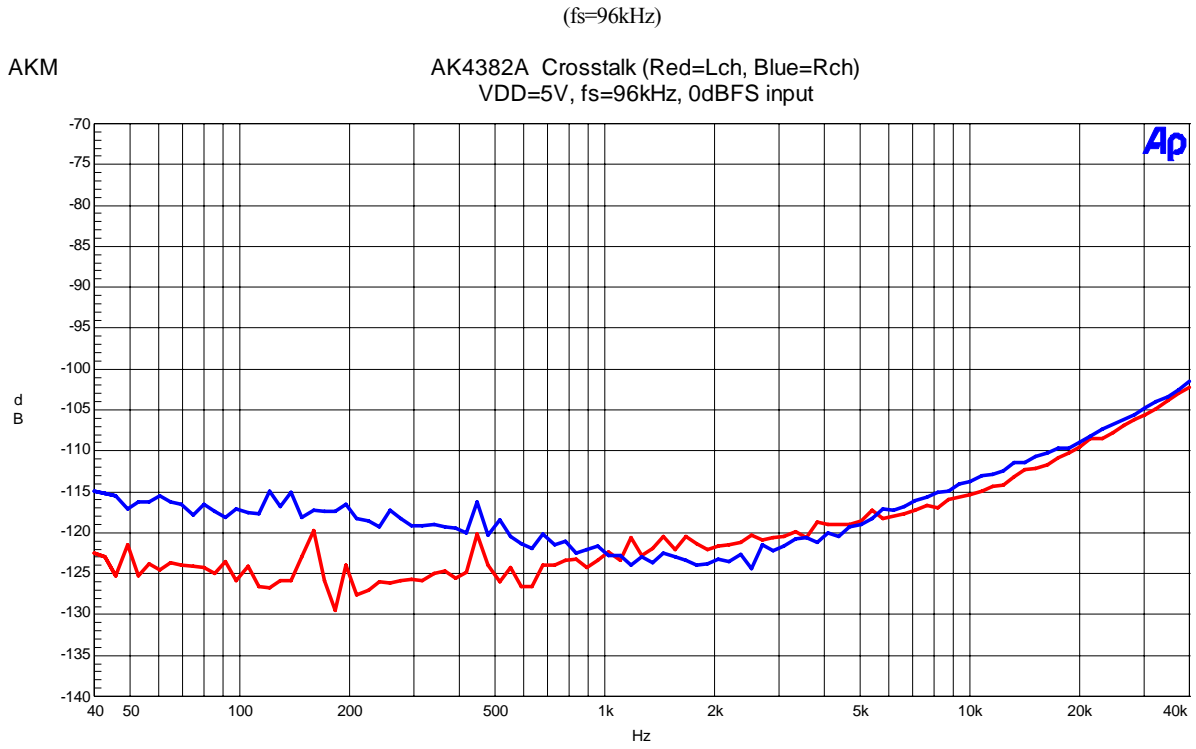


Figure 26. Crosstalk (0dBFS input)

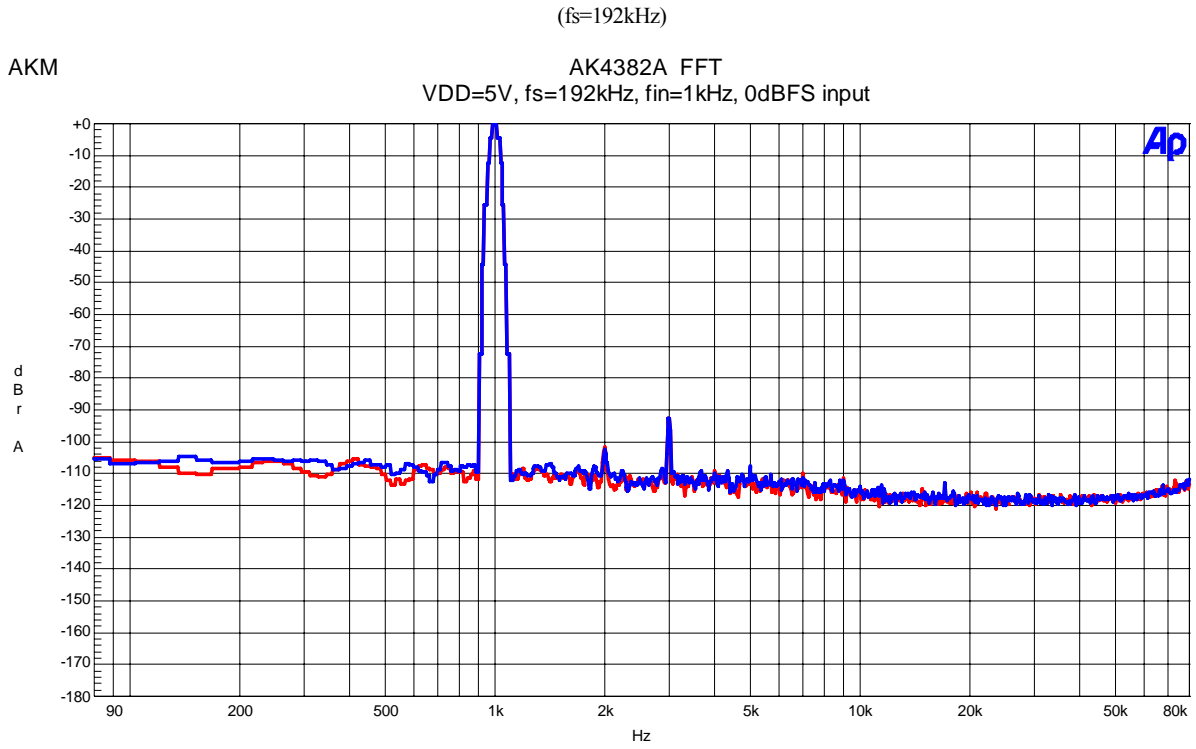


Figure 27. FFT (fin=1kHz, 0dBFS input)

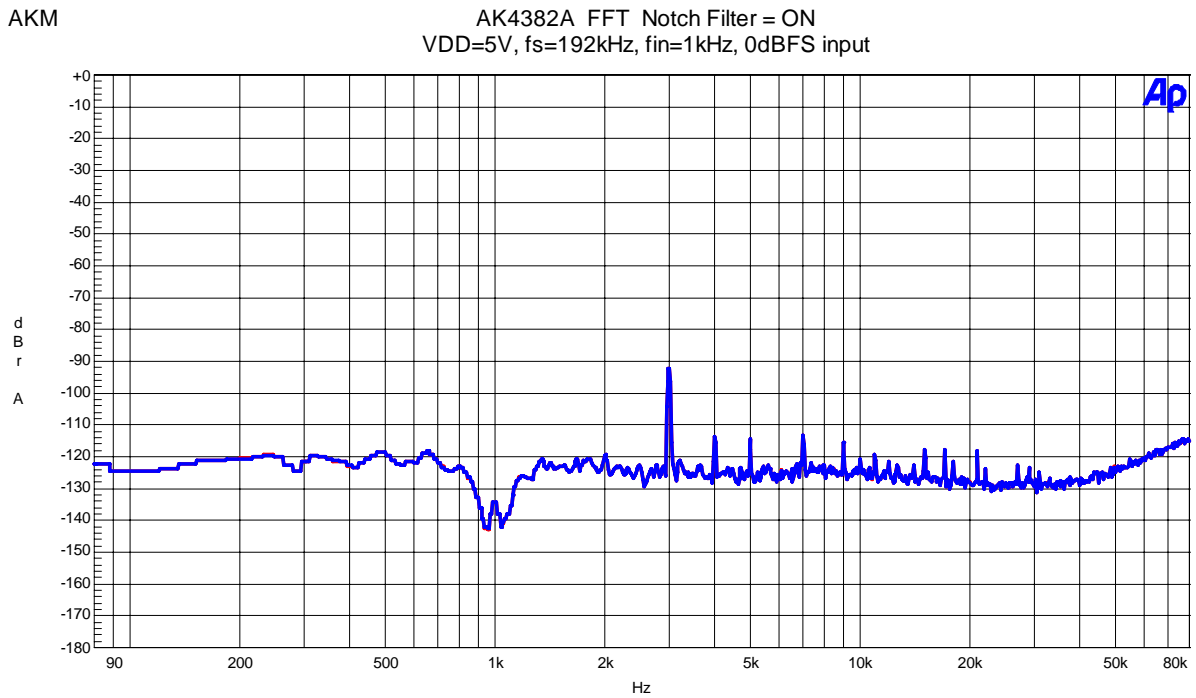


Figure 28. FFT(fin=1kHz, 0dBFS input, Notch)

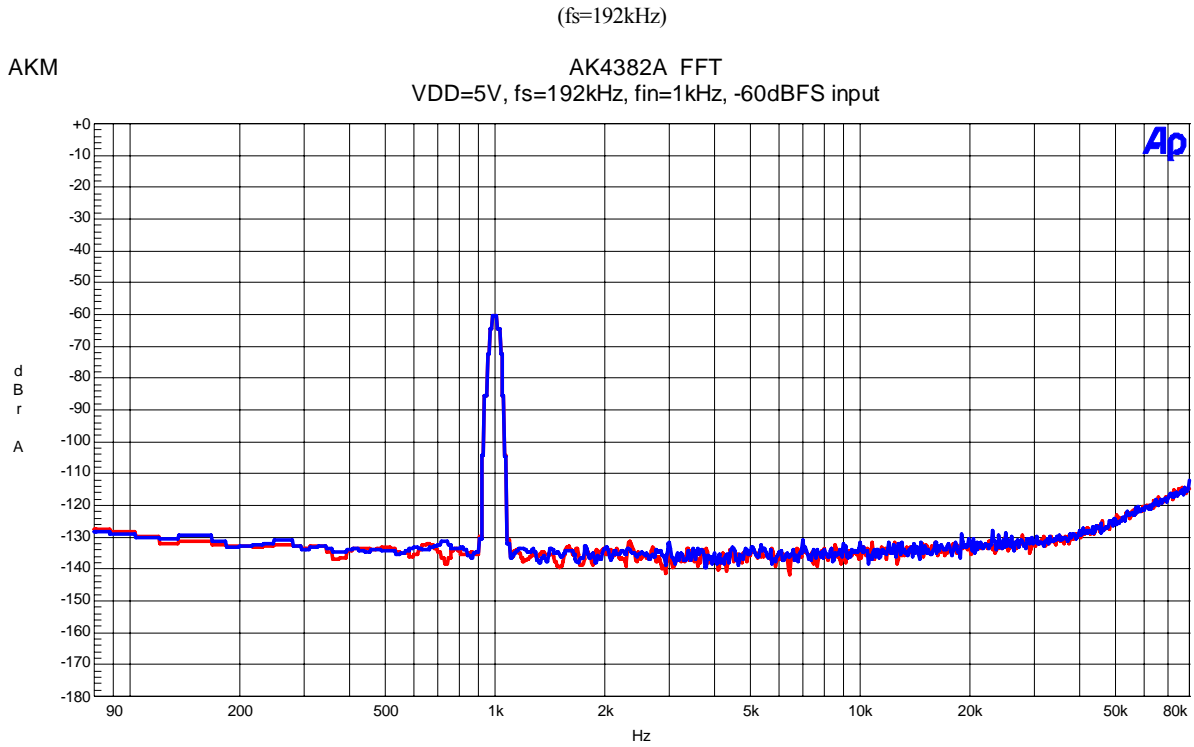


Figure 29. FFT (fin=1kHz, -60dBFS input)

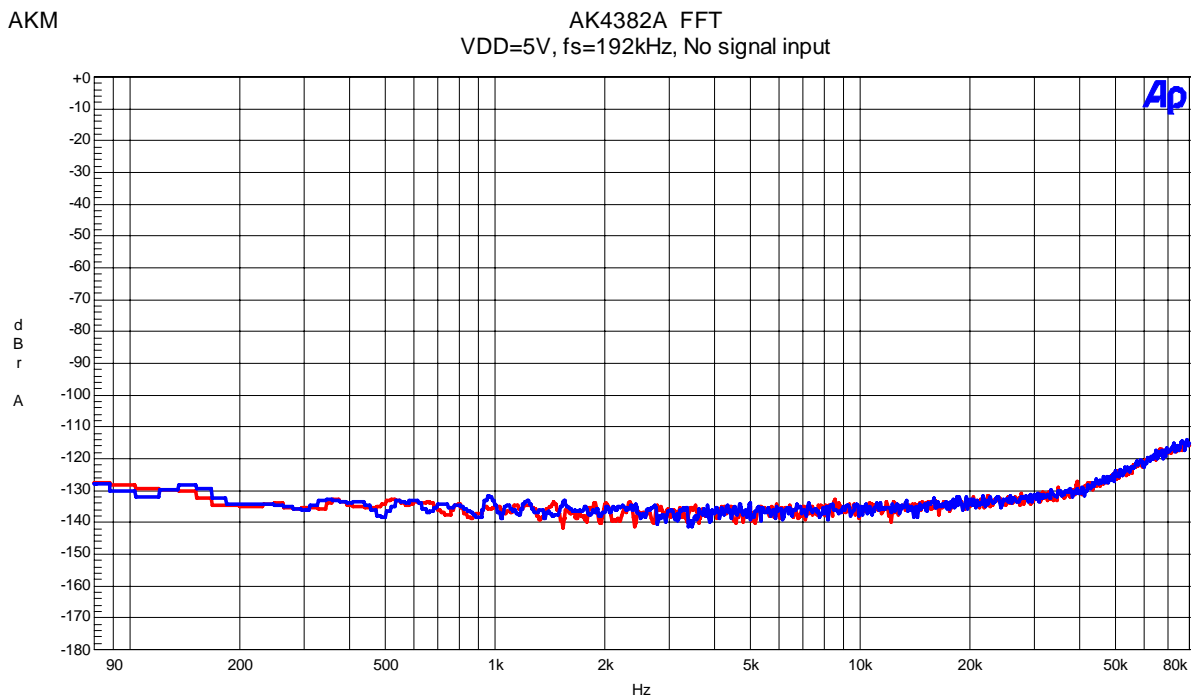


Figure 30. FFT (Noise Floor)



(fs=192kHz)

AKM

AK4382A THD+N vs. Input Level  
VDD=5V, fs=192kHz, fin=1kHz

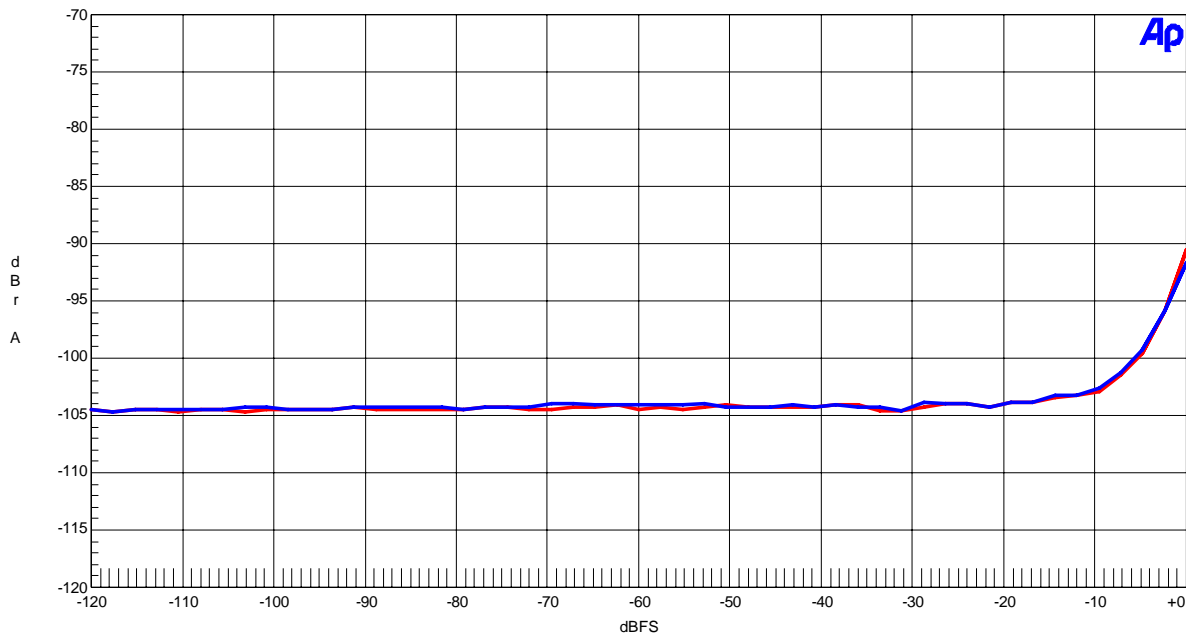


Figure 31. THD+N vs. Input level (fin=1kHz)

AKM

AK4382A THD+N vs. Input Frequency  
VDD=5V, fs=192kHz, 0dBFS input

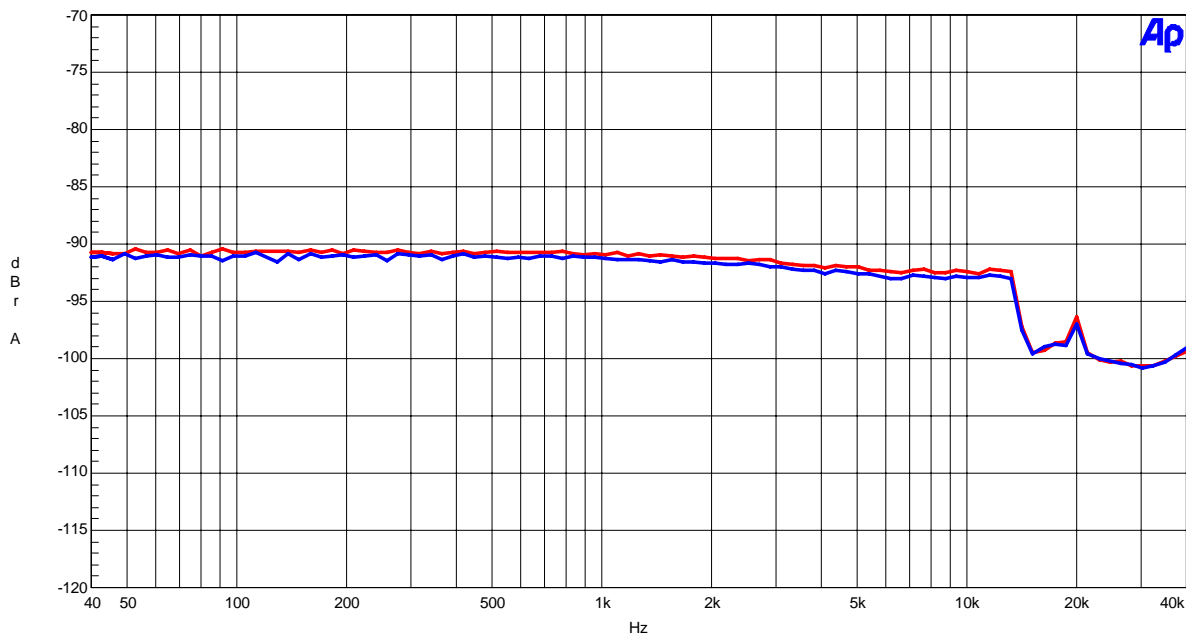


Figure 32. THD+N vs. Input Frequency (0dBFS input)

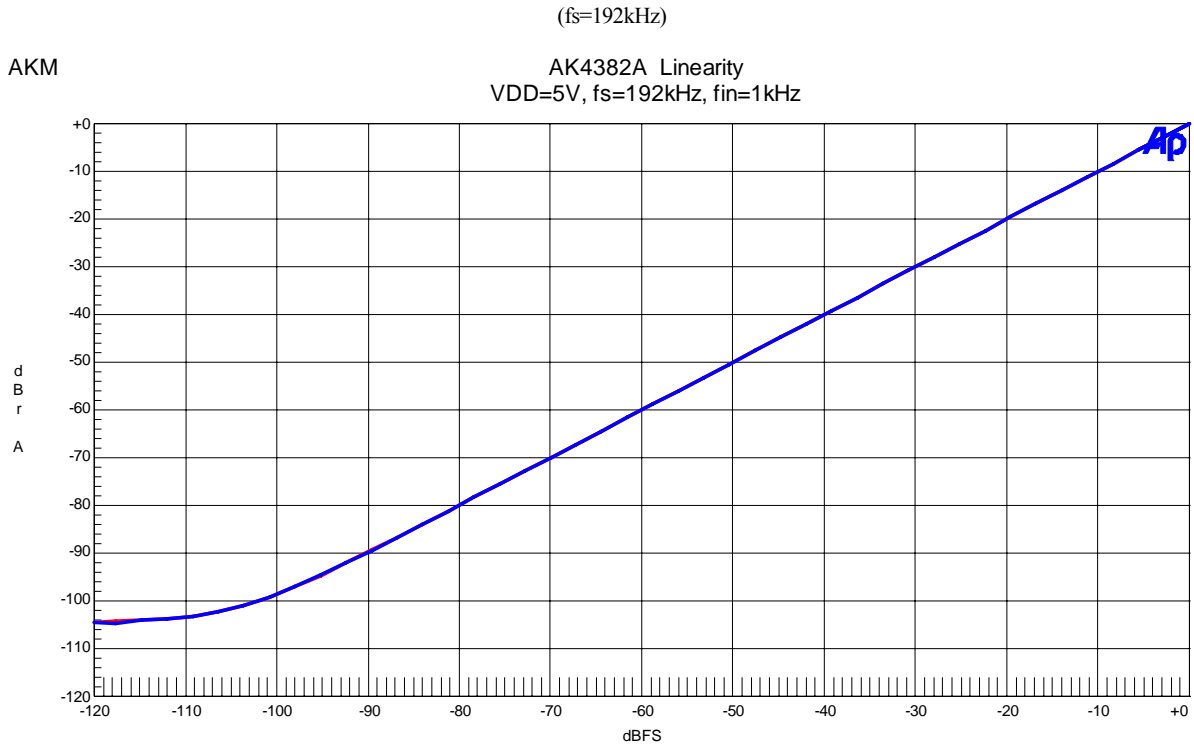


Figure 33. Linearity (fin=1kHz)

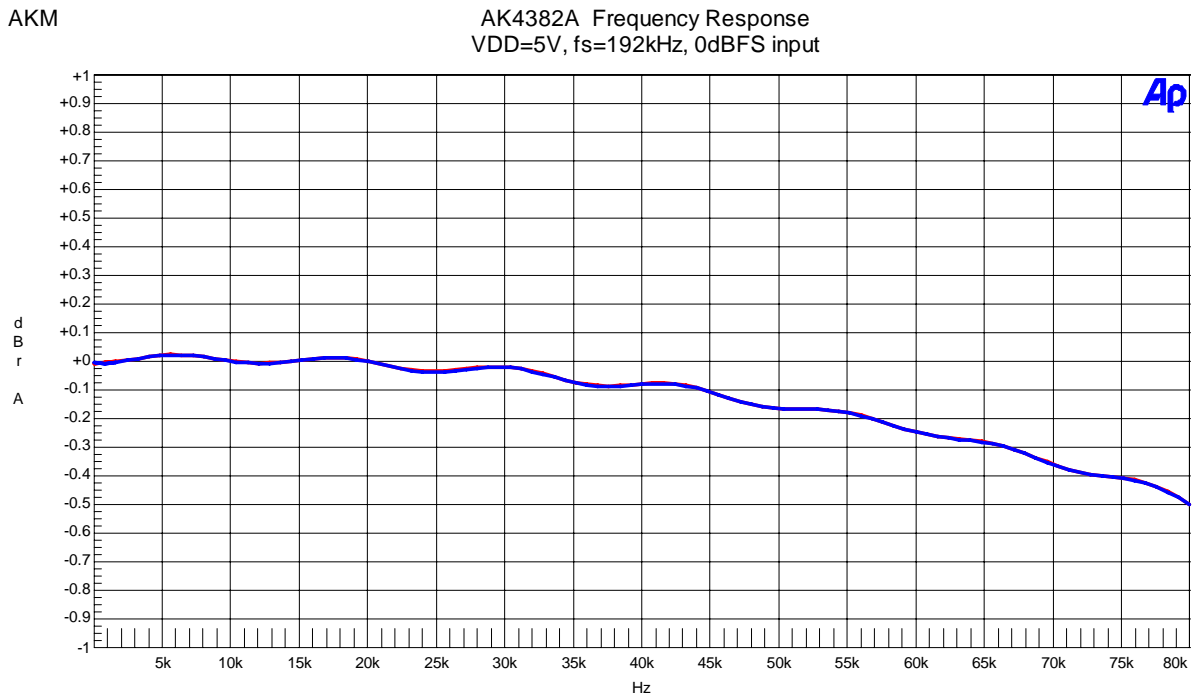


Figure 34. Frequency Response (0dBFS input)

(fs=192kHz)

AKM

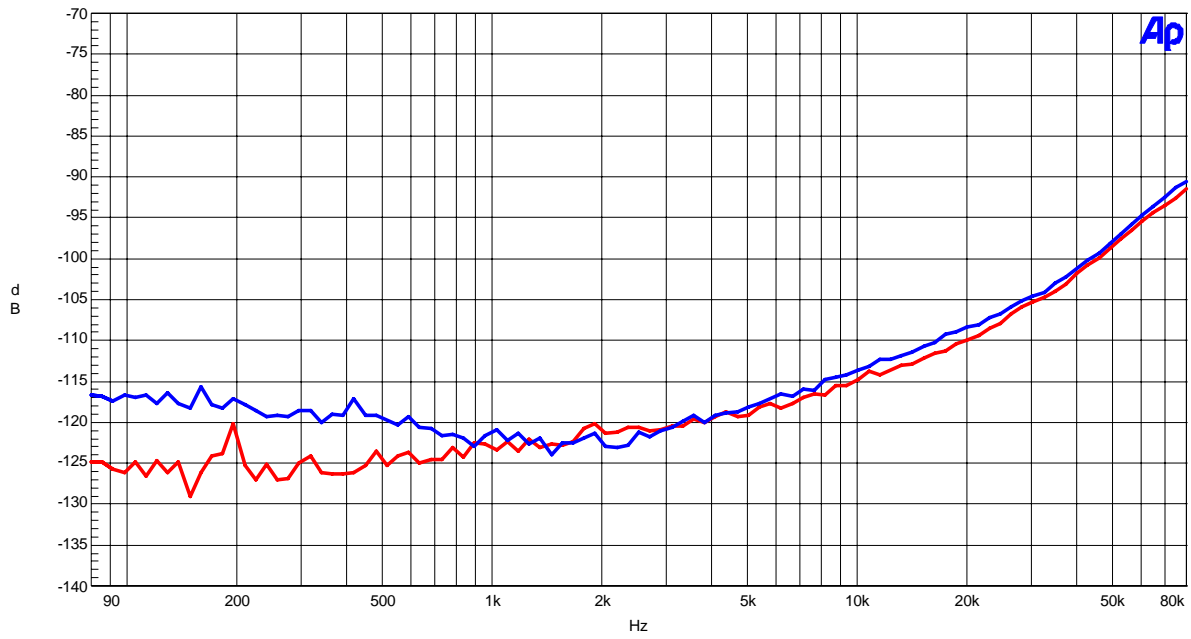
AK4382A Crosstalk (Red=Lch, Blue=Rch)  
VDD=5V, fs=192kHz, 0dBFS input

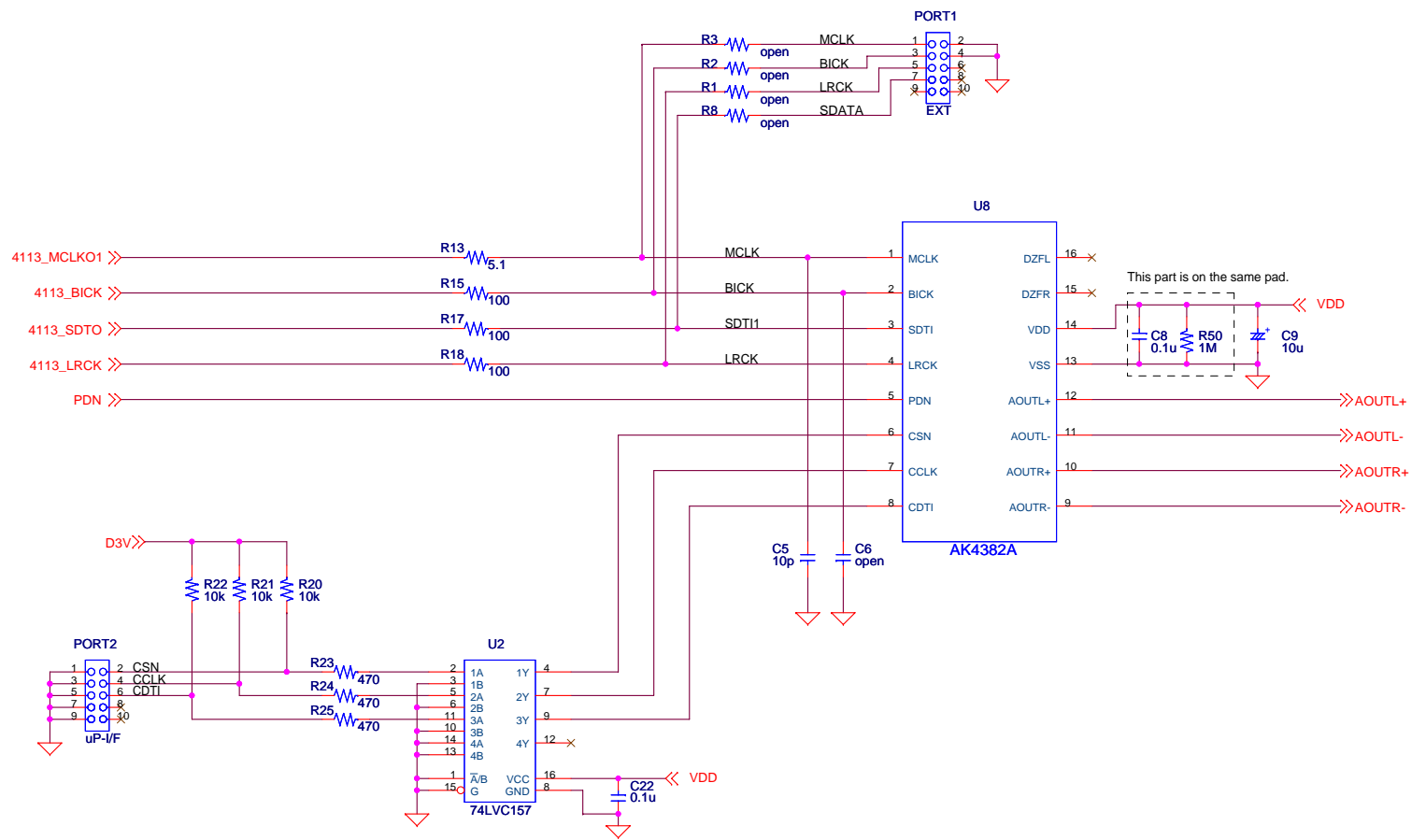
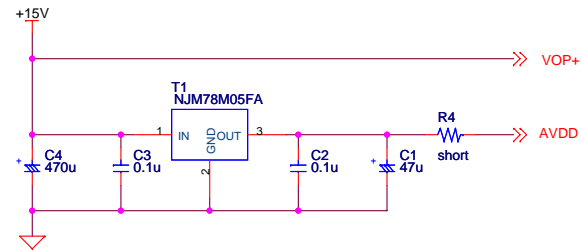
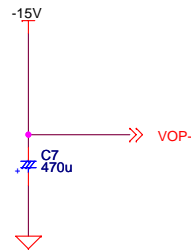
Figure 35. Crosstalk (0dBFS input)

<b>Revision History</b>
-------------------------

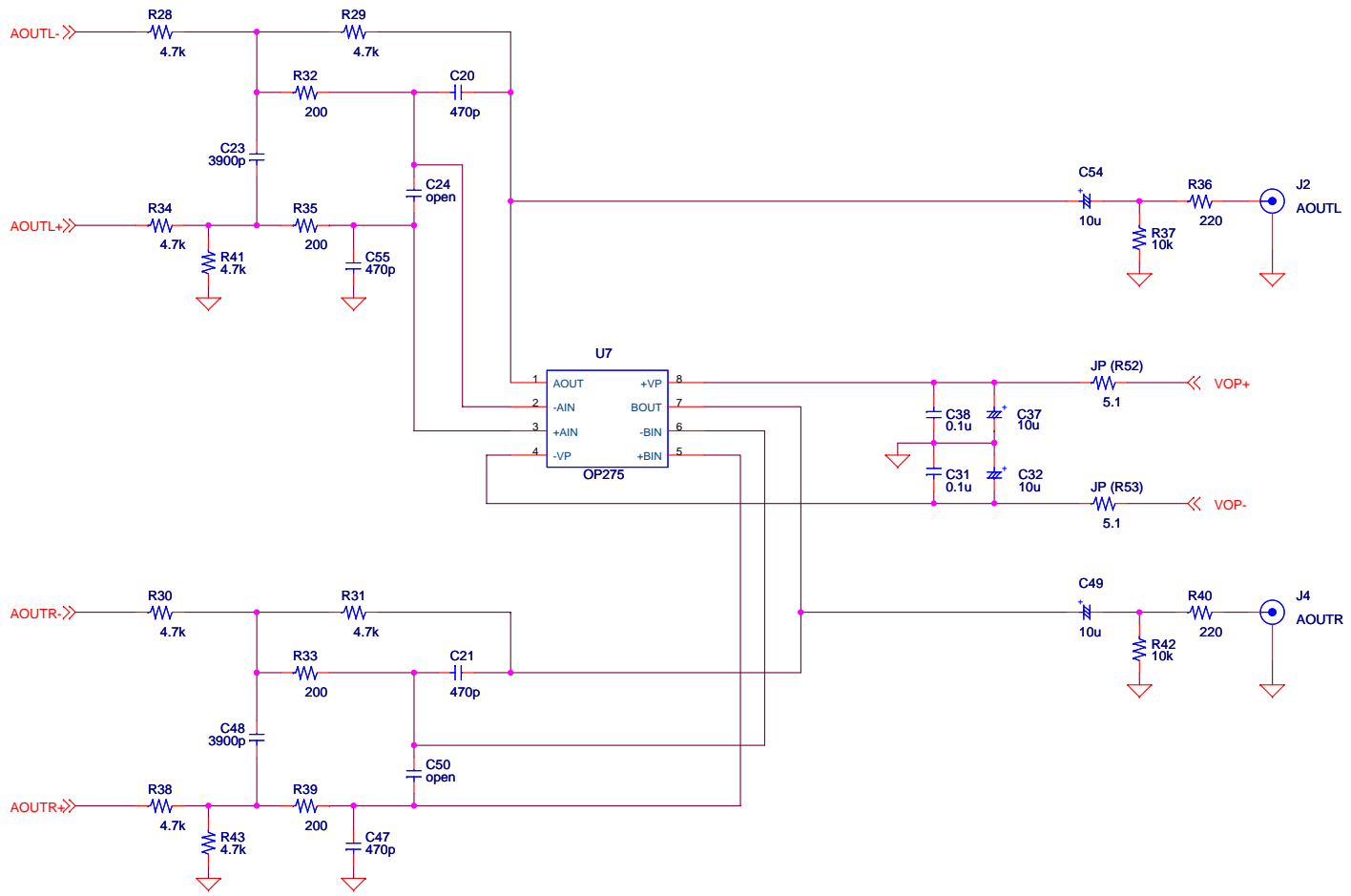
Date (YY/MM/DD)	Manual Revision	Board Revision	Reason	Contents
07/06/13	KM089400	0	First edition	

IMPORTANT NOTICE

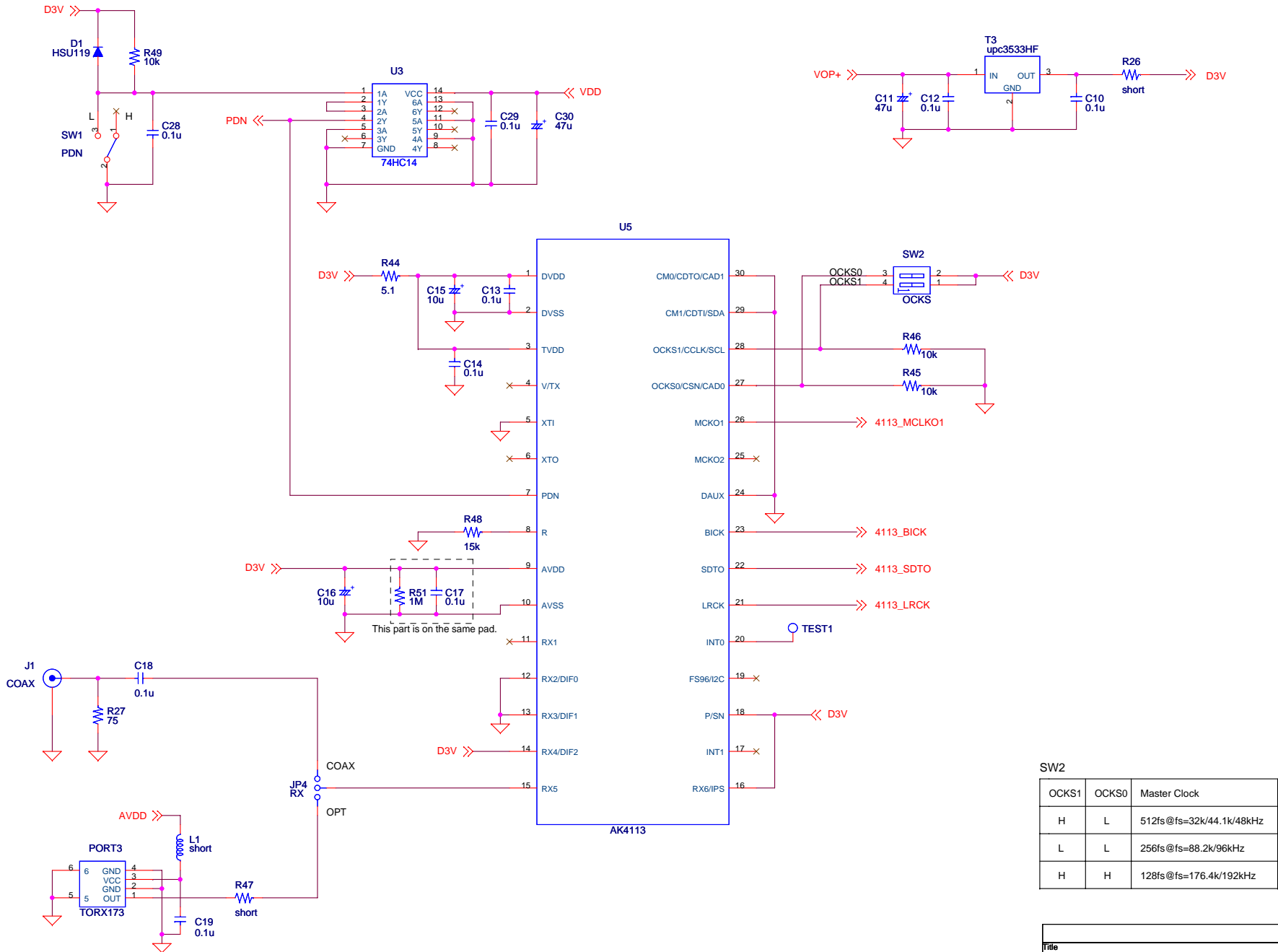
- These products and their specifications are subject to change without notice.  
When you consider any use or application of these products, please make inquiries the sales office of Asahi Kasei EMD Corporation (AKEMD) or authorized distributors as to current status of the products.
- AKEMD assumes no liability for infringement of any patent, intellectual property, or other rights in the application or use of any information contained herein.
- Any export of these products, or devices or systems containing them, may require an export license or other official approval under the law and regulations of the country of export pertaining to customs and tariffs, currency exchange, or strategic materials.
- AKEMD products are neither intended nor authorized for use as critical components<sub>Note1</sub> in any safety, life support, or other hazard related device or system<sub>Note2</sub>, and AKEMD assumes no responsibility for such use, except for the use approved with the express written consent by Representative Director of AKEMD. As used here:
  - Note1) A critical component is one whose failure to function or perform may reasonably be expected to result, whether directly or indirectly, in the loss of the safety or effectiveness of the device or system containing it, and which must therefore meet very high standards of performance and reliability.
  - Note2) A hazard related device or system is one designed or intended for life support or maintenance of safety or for applications in medicine, aerospace, nuclear energy, or other fields, in which its failure to function or perform may reasonably be expected to result in loss of life or in significant injury or damage to person or property.
- It is the responsibility of the buyer or distributor of AKEMD products, who distributes, disposes of, or otherwise places the product with a third party, to notify such third party in advance of the above content and conditions, and the buyer or distributor agrees to assume any and all responsibility and liability for and hold AKEMD harmless from any and all claims arising from the use of said product in the absence of such notification.



Title		
<b>AKD4382A-SB</b>		
Size	Document Number	Rev
A3	<b>AK4382A</b>	0
Date:	Thursday, May 10, 2007	Sheet 1 of 3



Title		
<b>AKD4382A-SB</b>		
Size	Document Number	Rev
A3	<b>Analog</b>	0
Date:	Thursday, May 10, 2007	Sheet 2 of 3



SW2

OCKS1	OCKS0	Master Clock
H	L	512fs @fs=32k/44.1k/48kHz
L	L	256fs @fs=88.2k/96kHz
H	H	128fs @fs=176.4k/192kHz

Title		
<b>AKD4382A-SB</b>		
Size	Document Number	Rev
A3	<b>AK4113</b>	0
Date:	Thursday, May 10, 2007	Sheet 3 of 3