

# AKD4394

## Evaluation board Rev.C for AK4394

General Description

The AKD4394 is an evaluation board for AK4394, which is 192kHz sampling 24Bit  $\Delta\Sigma$  DAC. The AKD4394 includes a LPF which can add differential analog outputs from the AK4394 and also has a digital interface with AKM's wave generator using ROM data and AKM's ADC evaluation boards. Therefore, it is easy to evaluate the AK4394.

■ **Ordering Guide**

AKD4394 Rev.C      --- Evaluation board Rev.C for AK4394: differential output

Function

- On-board differential output buffer circuit
- On-board clock generator
- BNC connector for an external clock input
- Compatible with 3types of interface
  1. Direct interface with evaluation boards for AKM's A/D converter (AKD539X, AKD535X)
  2. Interface with a signal generator (AKD43XX)
  3. On-board CS8414 as DIR which accepts optical input.

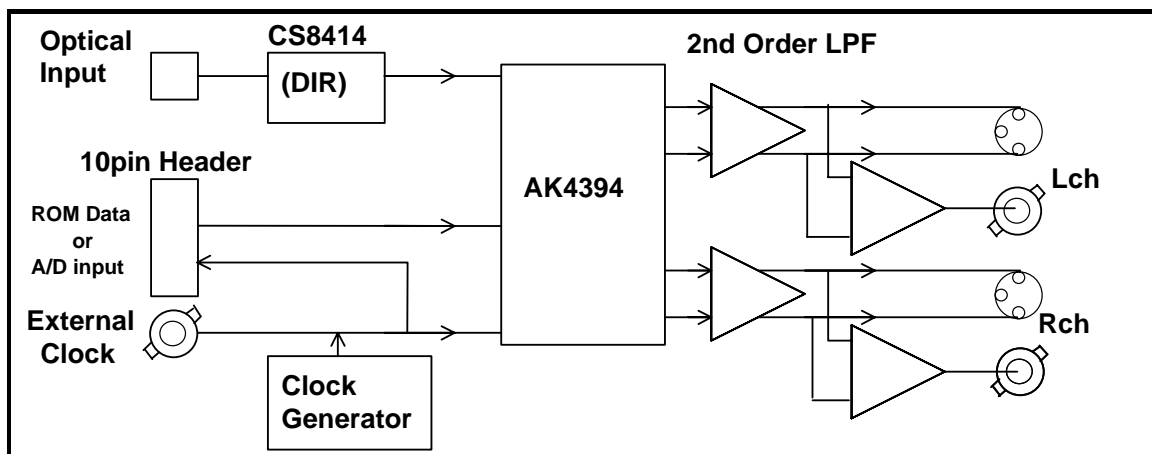

Fig.1 Block diagram

\* Circuit diagram and PCB layout are attached at the end of this manual.

(AKD4394 Rev.C is same as AKD4393 Rev.C.)

■ External Analog Circuit (Rev.C)

The differential output circuit and LPF is implemented on board. The differential outputs of AK4394 is buffered by non-inverted circuit and output via Cannon connector(differential output). LPF adds differential outputs. NJM5534D is used for op-amp on this board that has low noise and high voltage tolerance characteristics. Analog signal is output via Cannon and BNC connectors on the board. The output level is about 2.94Vrms(typ@VREF=5.0V) by Cannon and 2Vrms(typ@VREF=5.0V) by BNC.

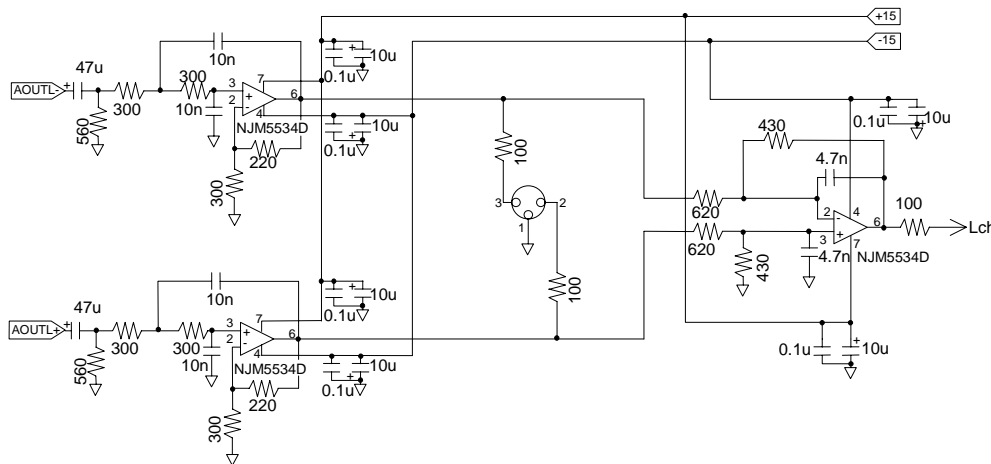

Fig.2 External Analog Filter

■ Operation sequence

1. Set up the jumpers for power supply.
  - [JP15(REG)] selects power supply for AVDD pin of AK4394.
    - short: 5V is supplied from regulator. (default)
    - Nothing should be connected to A5V jack.
    - open: 5V is supplied from A5V.
2. Set up the power supply lines.
  - +15V=15V, -15V=-15V: Power supply for op-amp. AVDD of AK4394 is supplied from “+15V” through regulator (JP15: short).
  - A5V=5V: This jack is used when AVDD of AK4394 is supplied from this. In this case, JP15 should be open.
  - DVDD=5V: Power supply for logic circuit on this board.
  - VP=3V~5.25V: Digital (set JP10 to VP),
  - AGND=DGND=0V .

Each supply line should be distributed from the power unit.
3. Set up the evaluation modes by jumper pins and DIP switches.(See next item.)
4. Power on.(The AK4394 should be reset once by bringing PD "L" upon power-up.)
  - \*SW1 resets the AK4394 during operation.
  - The AK4394 is reset at SW1="L" and exits resetting at SW1="H".

■ The evaluation modes and corresponding jumper pins setting

1. Evaluation Modes

●Applicable Evaluation Mode

- (1) DIR(Optical Link)
- (2) Ideal sine wave generated by ROM data
- (3) Using AD converted data
- (4)All interface signals including master clock are fed externally.

(1) DIR(Optical Link) (default)

PORT2 is used for the evaluation using such as CD test disk. The DIR generates MCLK, BICK and LRCK SDATA from the received data through optical connector(PORT2: TORX176).

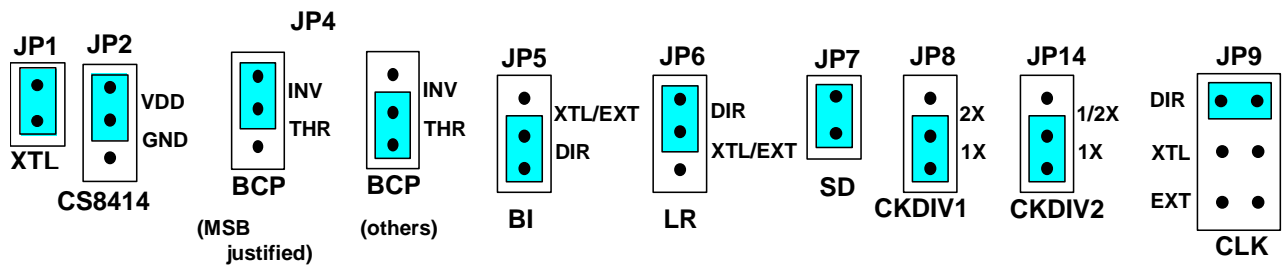

Fig.3 Jumper set-up (DIR)

(2) Ideal sine wave generated by ROM data

Digital signal generated by AKD43XX are used. PORT1 is used for the interface with AKD43XX. Master clock is sent from AKD4394 to AKD43XX then LRCK, BICK and SDATA are sent from AKD43XX to AKD4394.

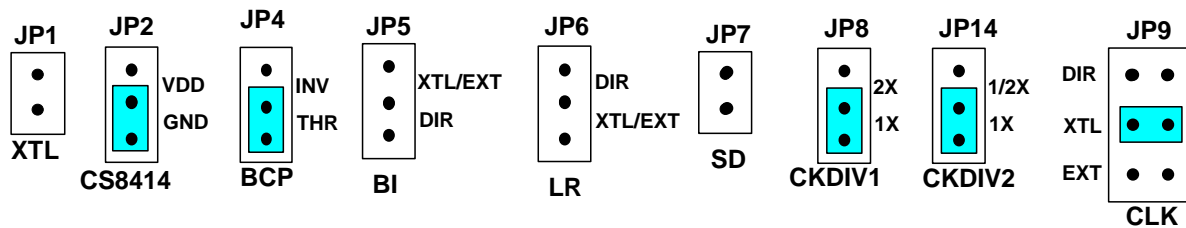

Fig.4 Jumper set-up (ROM data)

(3) Using AD converted data

AD converted data from AKM's AD evaluation boards(AKD539X, AKD535X) is used through PORT1.

\* In case of using external clock through a BNC connector, select EXT of JP9 and short JP1.

\* In case of using the double speed sampling mode, select 1/2X of JP8 and set S2-2(DFS) on.

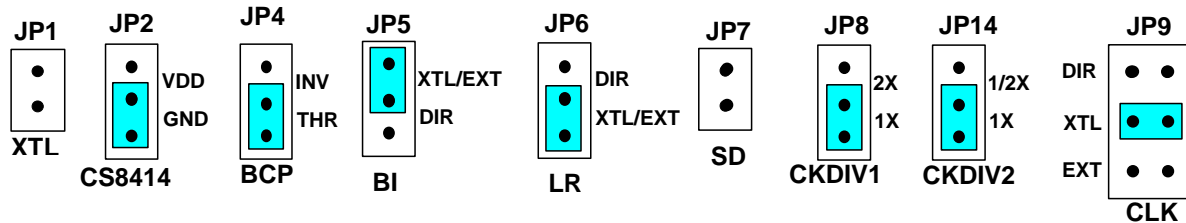

Fig.5 Jumper set-up (A/D)

(4) All interface signals including master clock are fed externally.

Under the following set-up, MCLK, LRCK and SCLK signals needed for the D/A to operate could be fed through PORT1.

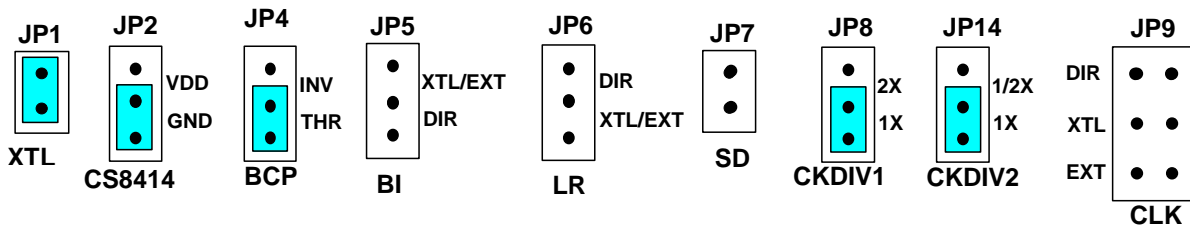

Fig.6 Jumper set-up (ext.)

2. MCLK set-up

When the LRCK is fed from the 74HC4040 on the board, The ratio of MCLK to LRCK can be selected by JP8 and JP14.

JP14	JP8	X'tal	MCLK	fs	MCLK/LRCK
1X	1X	12.288MHz	12.288MHz	48kHz	256
1X	2X	24.576MHz	24.576MHz	48kHz	512
1/2X	1X	24.576MHz	12.288MHz	96kHz	128
1/2X	2X	49.152MHz	12.288MHz	96kHz	128

Table.1 set-up example

3. BICK set-up

When BICK is supplied from U1(74HC4040), either 32fs or 64fs could be selected. Fig.8 shows 64fs mode. 64fs mode is recommended.

\*Only mode 0(LSB justified 16bit mode) can correspond to 32fs.

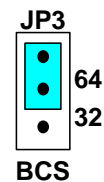

Fig.7 Jumper Set-up (BCS)

#### 4. DIP switch set-up

Confirm the set-up of the DIP switch before the operation. "ON" means "H" and "OFF" means "L".

##### 4-1. Set-up of SW3, SW4(Mode set-up of AK4394: see the data sheet of AK4394)

DIF2	DIF1	DIF0	Mode	BICK
OFF	OFF	OFF	0: LSB justified, 16bit	≥32fs
OFF	OFF	ON	1: LSB justified, 20bit	≥40fs
OFF	ON	OFF	2: LSB justified, 24bit	≥48fs
OFF	ON	ON	3: I <sup>2</sup> S	≥48fs
ON	OFF	OFF	4: MSB justified, 24bit	≥48fs

(default)

Table 2 Audio Serial Interface Format Select Pins (SW3-5,6,7)

##### 4-2. Set-up of SW6 (Mode set-up of CS8414. About details, see the data-sheet of CS8414)

Adjust the audio data format of CS8414 (DIR) to AK4394. CS8414 does not match the LSB justified 20bit/24bit mode of AK4394.

M3 (SW6-2)	M2 (SW6-3)	M1 (SW6-4)	M0 (SW6-5)	Data format	JP4
OFF	OFF	OFF	OFF	MSB justified, 24bit	INV
OFF	OFF	ON	OFF	I <sup>2</sup> S	THR
OFF	ON	OFF	ON	LSB justified, 16bit	THR

(default)

Table 3 Set-up of SW6

SW6-1(SEL) :Usually ON.

SW6-6(CS12): Select the channel for indicating the channel status.

ON: Rch (default), OFF: Lch

#### 5. Parallel/Serial Control

SW5: set up P/S pin of AK4394.

H: parallel mode. PORT3 is used JP11, 12 and 13 should be open.

L: serial mode. PORT3 is used. JP11, 12 and 13 should be open.

#### 6. Other set-up

SW1: Reset of AK4394. Select "H" during operation.

SW2: Soft-mute of AK4394. The soft-mute is executed during SW2 pushed.

LE1 : This LED shows pre-emphasis status. It turns on when the data is pre-emphasized.

LE2 : This LED shows the output of VERR pin in CS8414. It turns on when the error is occurred in CS8414.

<b>Control Software Manual</b>
--------------------------------

### ■ Set-up of evaluation board and control software

1. Set up the AKD4394 according to previous term.
2. Connect IBM-AT compatible PC with AKD4394 by 10-line type flat cable (packed with AKD4394). Take care of the direction of 10pin header. (Please install the driver in the CD-ROM when this control software is used on Windows 2000/XP. Please refer "Installation Manual of Control Software Driver by AKM device control software". In case of Windows95/98/ME, this installation is not needed. This control software does not operate on Windows NT.)
3. Insert the CD-ROM labeled "AKD4394 Evaluation Kit" into the CD-ROM drive.
4. Access the CD-ROM drive and double-click the icon of "akd4394.exe" to set up the control program.
5. Then please evaluate according to the follows.

### ■ Operation flow

Keep the following flow.

1. Set up the control program according to explanation above.
2. Click "Port Reset" button.

### ■ Explanation of each buttons

- |                     |   |
|---------------------|---|
| 1. [Port Reset]:    | Set up the USB interface board (AKDUSBIF-A).  |
| 2. [Write default]: | Initialize the register of AK4394.  |
| 3. [All Write]:     | Write all registers that is currently displayed.  |
| 4. [Function1]:     | Dialog to write data by keyboard operation.   |
| 5. [Function3]:     | The sequence of register setting can be set and executed.   |
| 6. [Function4]:     | The sequence that is created on [Function3] can be assigned to buttons and executed.                            |
| 7. [Function5]:     | The register setting that is created by [SAVE] function on main window can be assigned to buttons and executed. |
| 8. [SAVE]:          | Save the current register setting.  |
| 9. [OPEN]:          | Write the saved values to all register.   |
| 10. [Write]:        | Dialog to write data by mouse operation.  |

### ■ Indication of data

Input data is indicated on the register map. Red letter indicates "H" or "1" and blue one indicates "L" or "0". Blank is the part that is not defined in the datasheet.

## ■ Explanation of each dialog

### 1. [Write Dialog]: Dialog to write data by mouse operation

There are dialogs corresponding to each register.

Click the [Write] button corresponding to each register to set up the dialog. If you check the check box, data becomes “H” or “1”. If not, “L” or “0”.

When writing the input data to AK4394, click [OK] button. If not, click [Cancel] button.

### 2. [Function1 Dialog]: Dialog to write data by keyboard operation

Address Box:	Input registers address in 2 figures of hexadecimal.
Data Box:	Input registers data in 2 figures of hexadecimal.

When writing the input data to AK4394, click [OK] button. If not, click [Cancel] button.

### 3. [Save] and [Open]

#### 3-1. [Save]

Save the current register setting data. The extension of file name is “.akr”.

(Operation flow)

Click [Save] Button.

Set the file name and push [Save] Button. The extension of file name is “.akr”.

#### 3-2. [Open]

The register setting data saved by [Save] is written to AK4394. The file type is the same as [Save].

(Operation flow)

(1) Click [Open] Button.

(2) Select the file (\*.akr) and Click [Open] Button.



#### 4. [Function3 Dialog]

The sequence of register setting can be set and executed.

(1) Click [F3] Button.

(2) Set the control sequence.

Set the address, Data and Interval time. Set "-1" to the address of the step where the sequence should be paused.

(3) Click [Start] button. Then this sequence is executed.

The sequence is paused at the step of Interval="-1". Click [START] button, the sequence restarts from the paused step.

This sequence can be saved and opened by [Save] and [Open] button on the [Function3] window. The extension of file name is "aks".

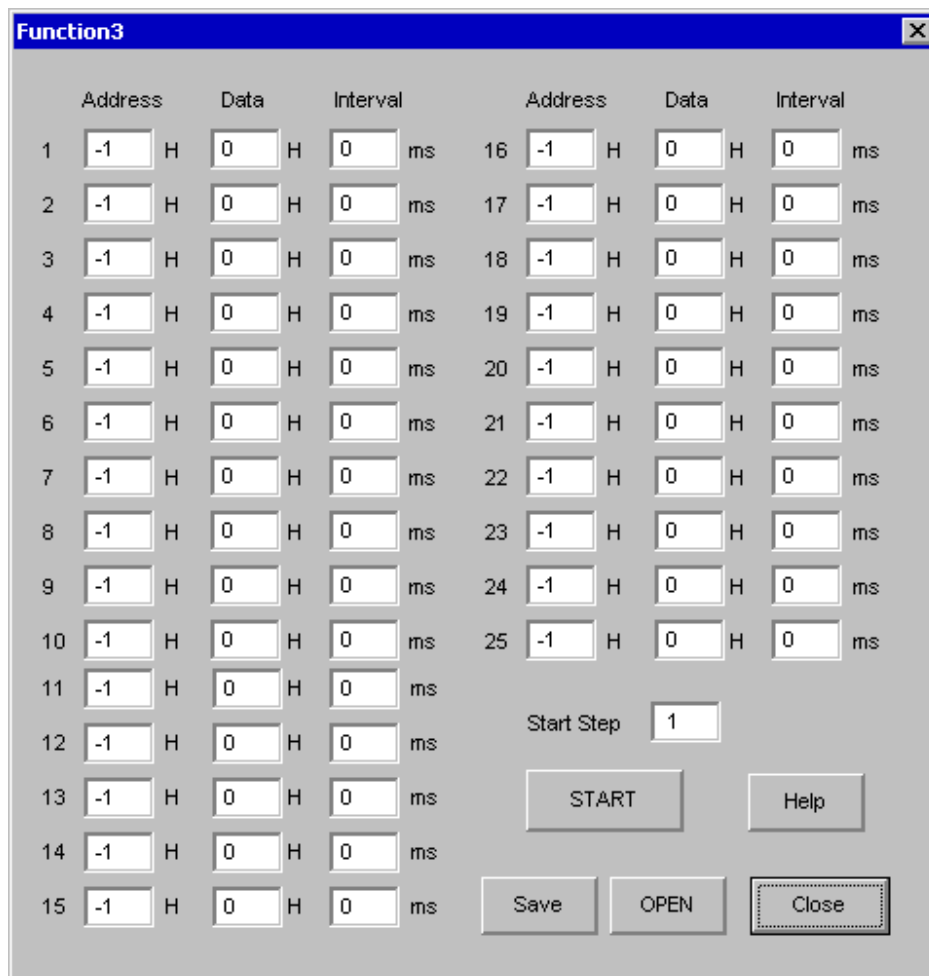

Figure 1. Window of [F3]

### 5. [Function4 Dialog]

The sequence that is created on [Function3] can be assigned to buttons and executed. When [F4] button is clicked, the window as shown in **Figure 2** opens.

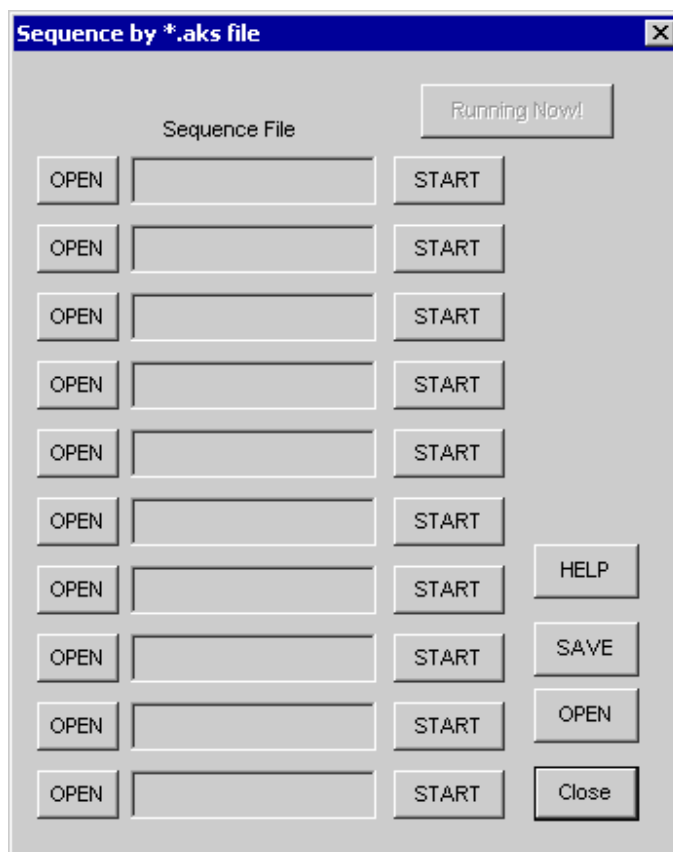

Figure 2. [F4] window

**5-1. [OPEN] buttons on left side and [START] buttons**

(1) Click [OPEN] button and select the sequence file (\*.aks).

The sequence file name is displayed as shown in Figure 3.

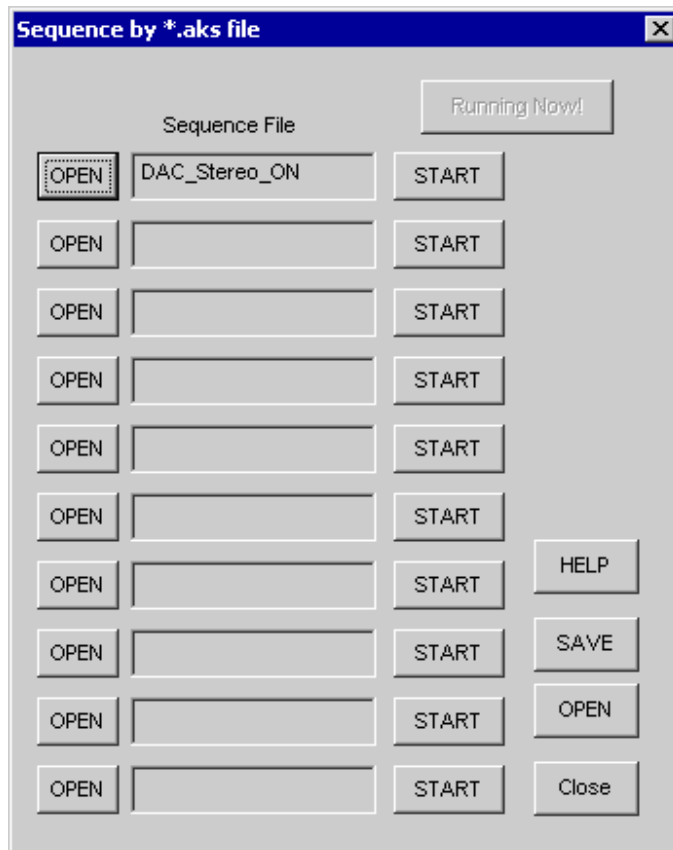

Figure 3. [F4] window(2)

(2) Click [START] button, then the sequence is executed.

### 5-2. [SAVE] and [OPEN] buttons on right side

[SAVE]: The sequence file names can assign be saved. The file name is \*.ak4.

[OPEN]: The sequence file names assign that are saved in \*.ak4 are loaded.

### 5-3. Note

(1) [Function4] doesn't support the pause function of sequence function.

(2) All files need to be in same folder used by [SAVE] and [OPEN] function on right side.

(3) When the sequence is changed in [Function3], the file should be loaded again in order to reflect the change.

**6. [Function5 Dialog]**

The register setting that is created by [SAVE] function on main window can be assigned to buttons and executed. When [F5] button is clicked, the following window as shown in **Figure 4** opens.

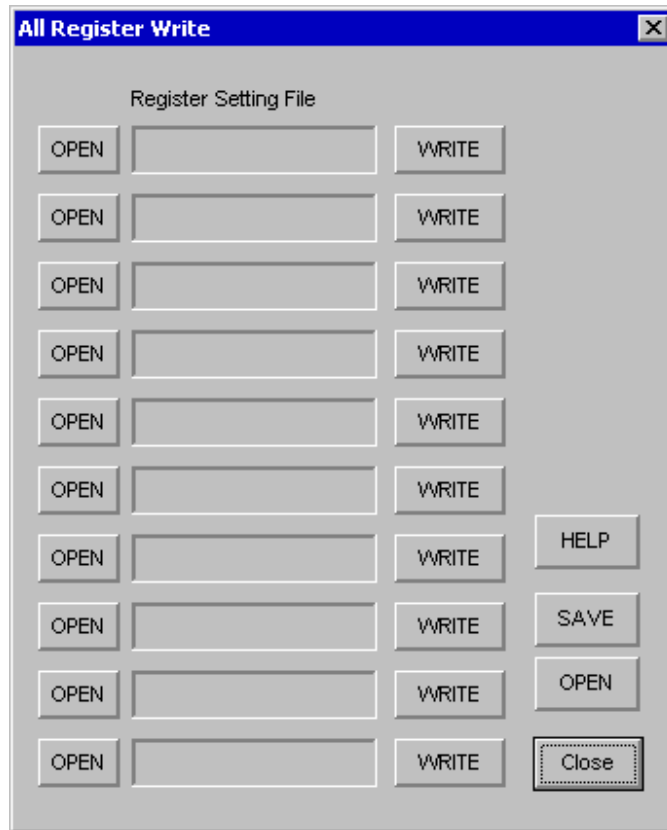

Figure 4. [F5] window

**6-1. [OPEN] buttons on left side and [WRITE] button**

- (1) Click [OPEN] button and select the register setting file (\*.akr).
- (2) Click [WRITE] button, then the register setting is executed.

**6-2. [SAVE] and [OPEN] buttons on right side**

[SAVE]: The register setting file names assign can be saved. The file name is \*.ak5.

[OPEN]: The register setting file names assign that are saved in \*.ak5 are loaded.

**6-3. Note**

- (1) All files need to be in same folder used by [SAVE] and [OPEN] function on right side.
- (2) When the register setting is changed by [Save] Button in main window, the file should be loaded again in order to reflect the change.

■ **AK4394 Measurement Example**

Conditions:

AVDD =DVDD= 5.0V

Interface = DIR (44.1kHz, 96kHz)

MCLK = 256fs(fs=44.1kHz, 96kHz)

BICK = 64fs

fs = 44.1kHz, 96kHz,

Input data = 24bit

Measurement unit: Audio Precision System Two Cascade (fs=44.1kHz, 96kHz)

(AKD4394 Rev.C: differential output)

fs		Result	
44.1kHz	THD+N	100.3	20kLPF
	DR	120.1	22kLPF + A-weighted
	S/N	120.2	22kLPF + A-weighted
96kHz	THD+N	99.6	40kLPF
	DR	119.2	80kLPF + A-weighted
	S/N	119.8	80kLPF + A-weighted

Plot:

FFT Point: 16384

Window: Equiripple

Averages: 4

(fs=44.1kHz)

AKM

AK4394 FFT (Input Level=0dBFS, fin=1 kHz)

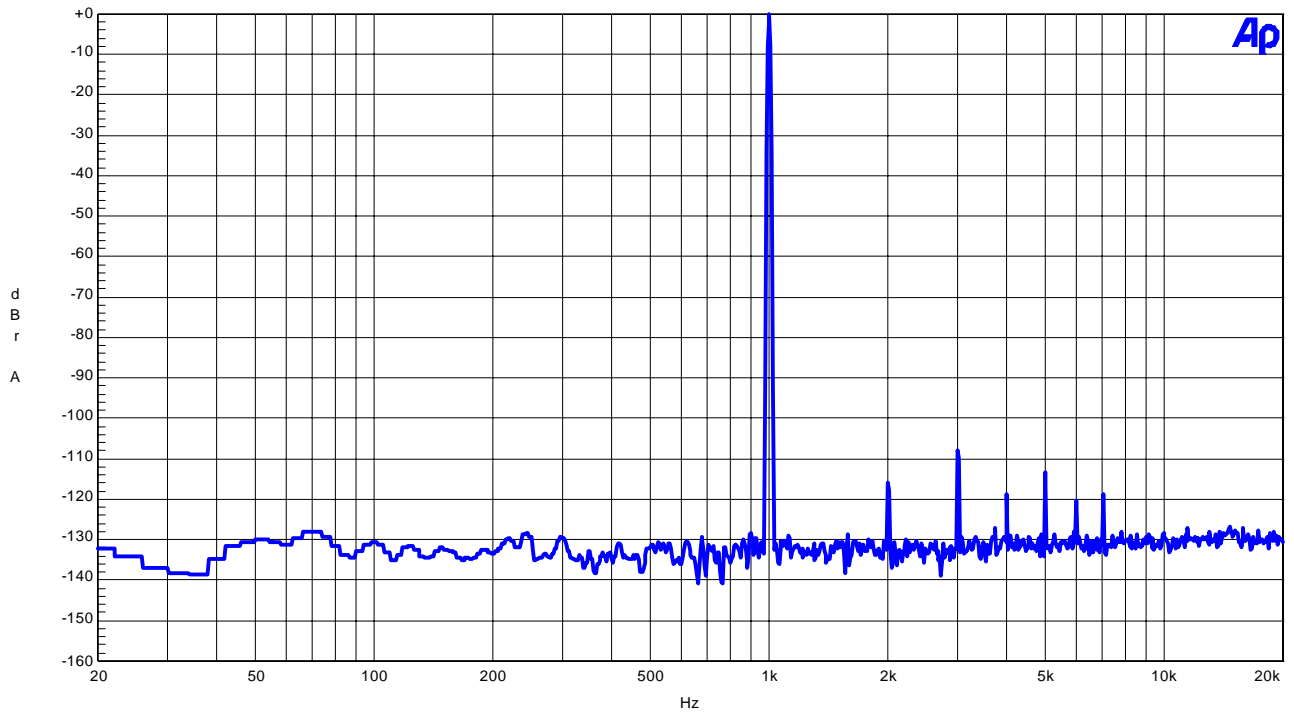

FFT (Input Level=0dBFS, fin=1kHz)



AKM

AK4394 FFT(Input Level=-60dBFS,fin=1kHz)

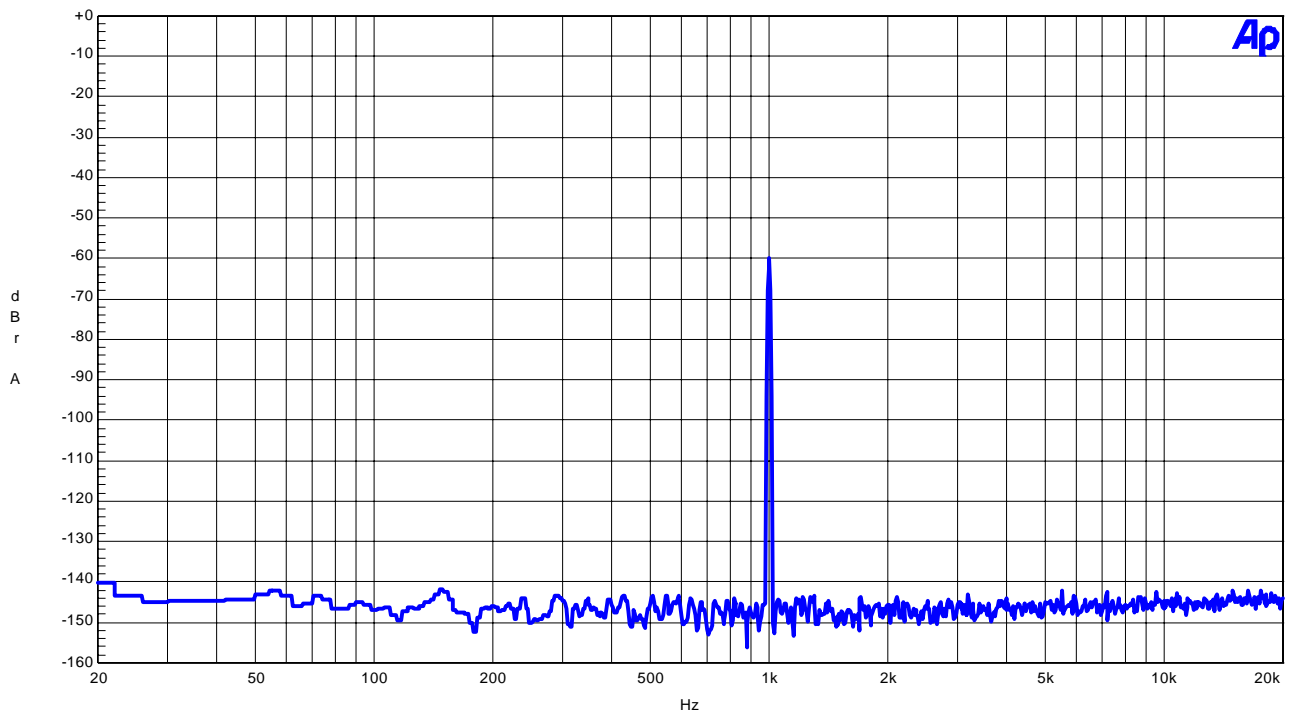

FFT (Input Level=-60dBFS, fin=1kHz)

(fs=44.1kHz)

AKM

AK4394 FFT(Input="0"data)

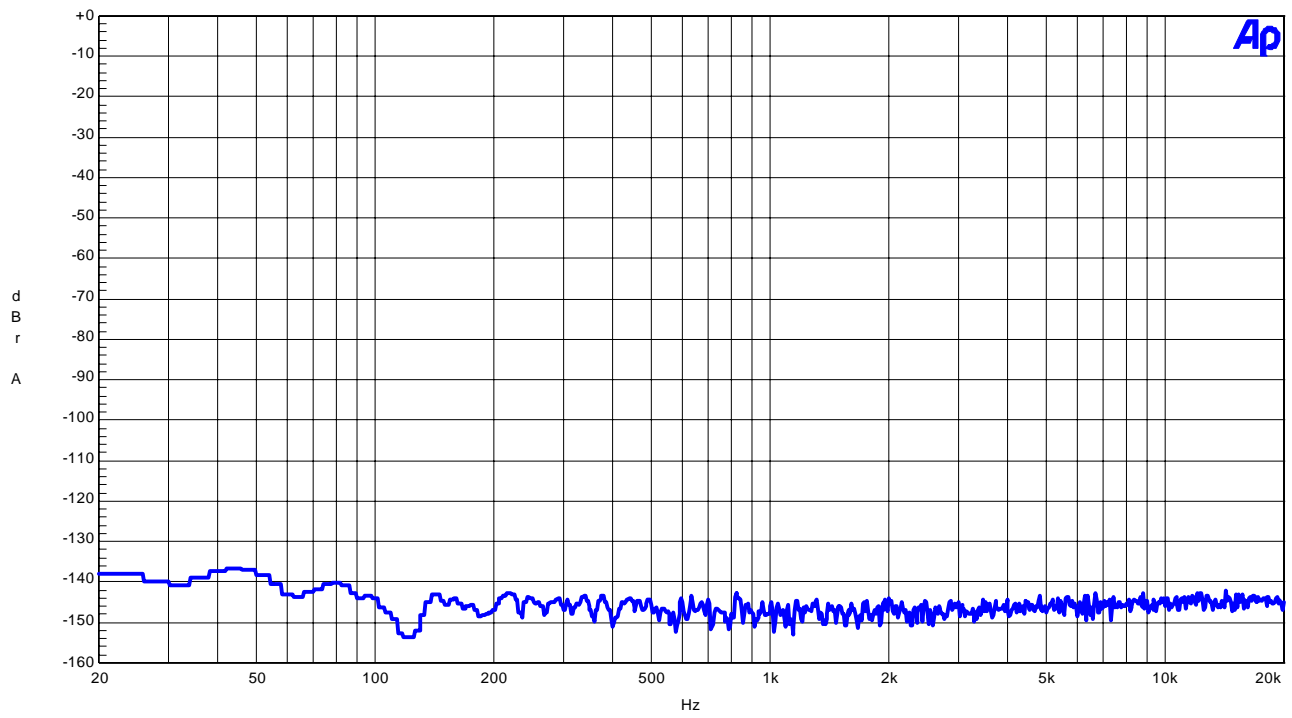

FFT (noise floor)

AKM

AK4394 FFT(Input = "0"data, out-of band)

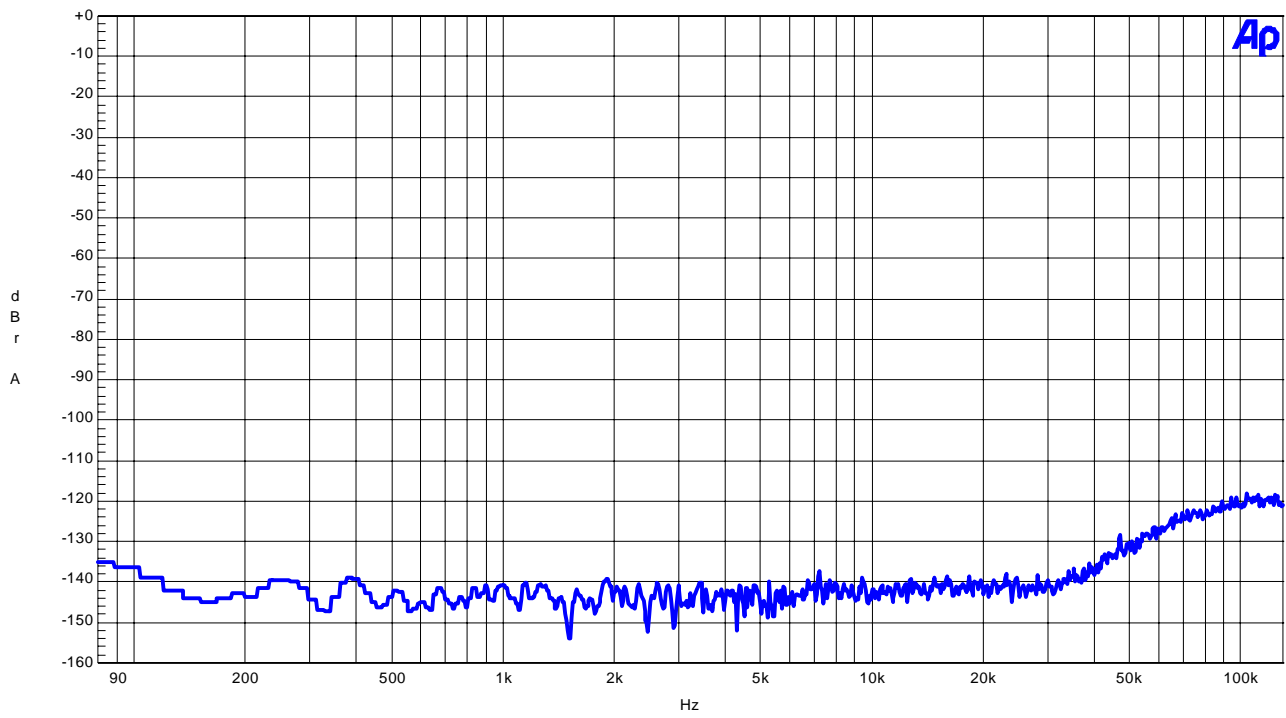

FFT (noise floor, out-of band)

(fs=44.1kHz)  
AKM AK4394 THD + N vs Amplitude(fin=1kHz)

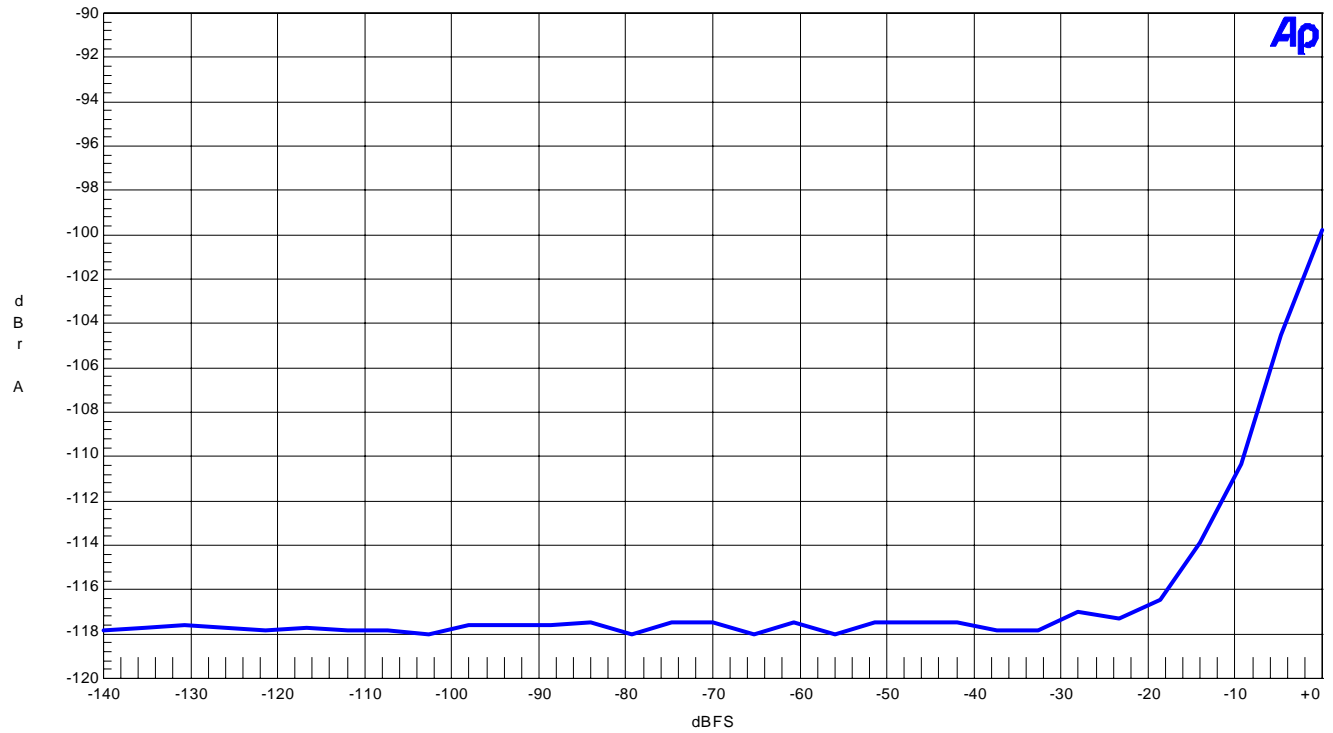

THD + N vs Amplitude (fin=1kHz)  
AKM AK4394 THD + N vs Input Frequency(Input Level=0dBFS)

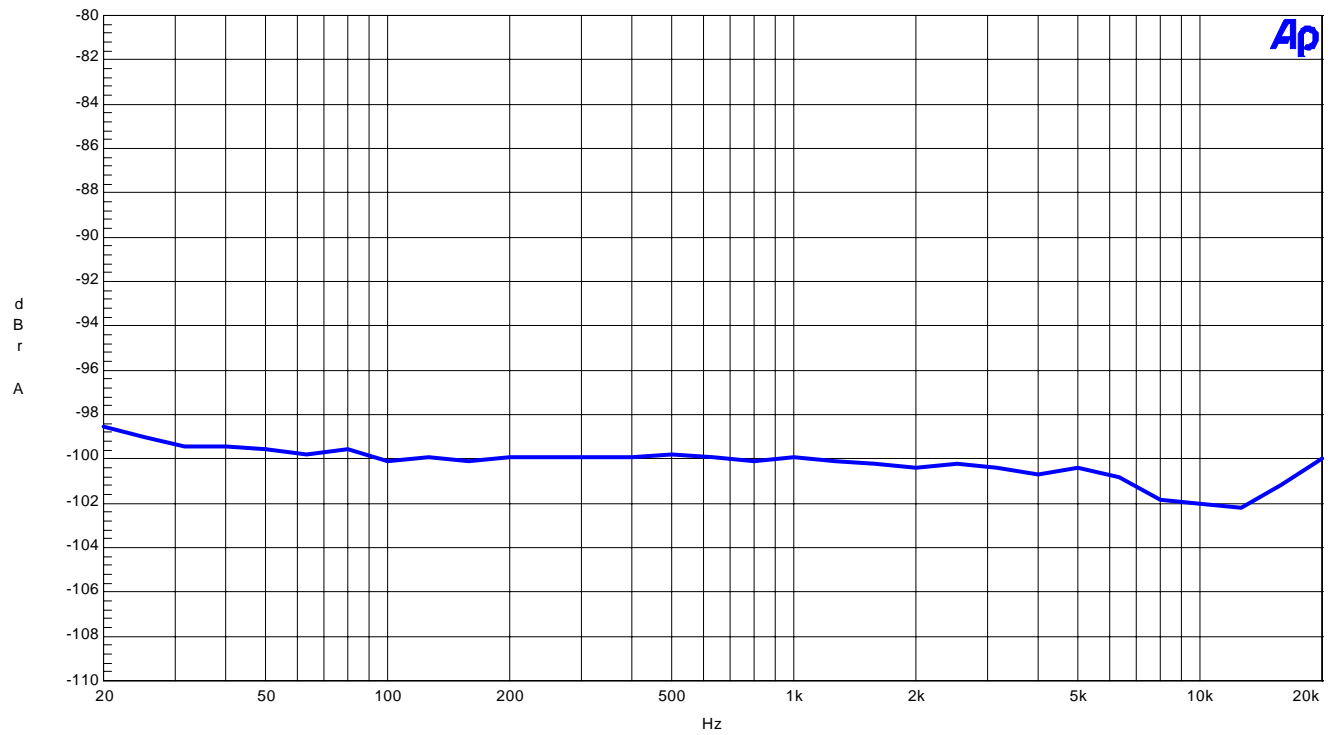

THD +N vs Input Frequency (Input Level=0dBFS)

(fs=44.1kHz)  
AK4394 Linearity

AKM

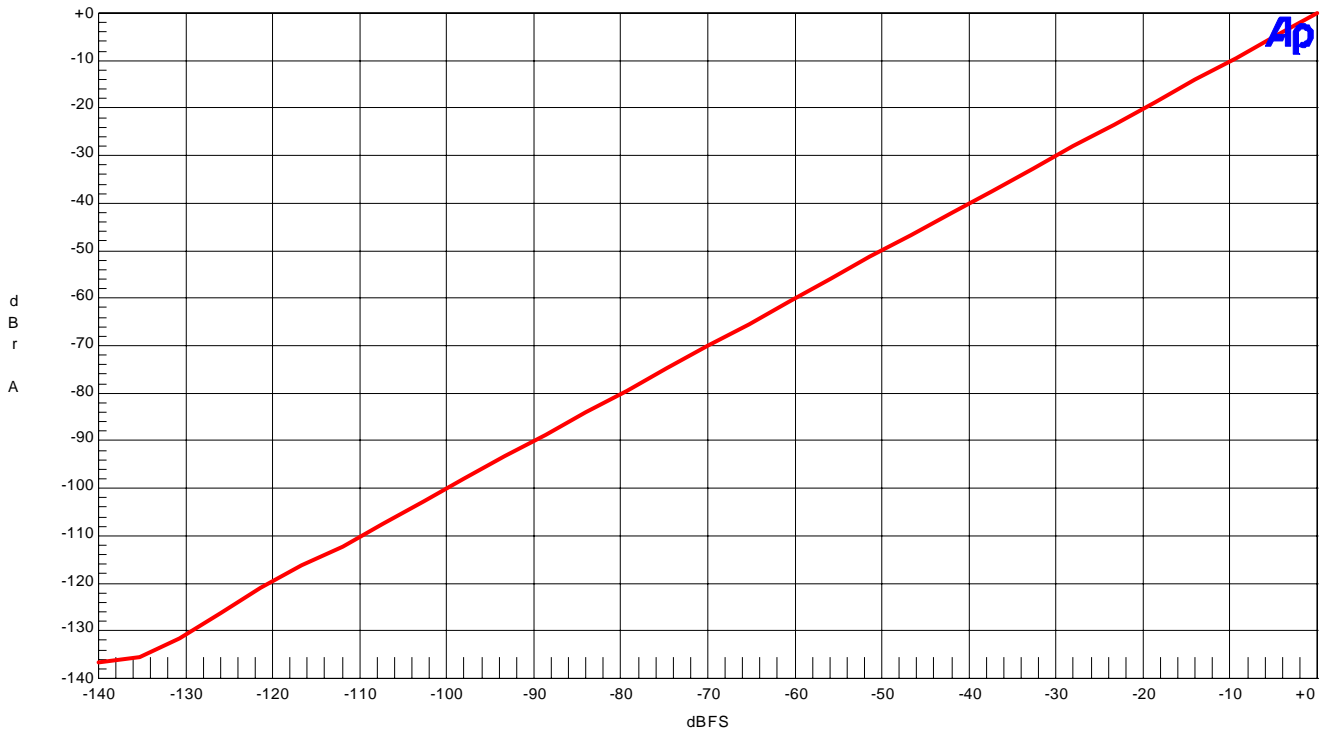

Linearity (fin=1kHz)  
AK4394 Frequency Response

AKM

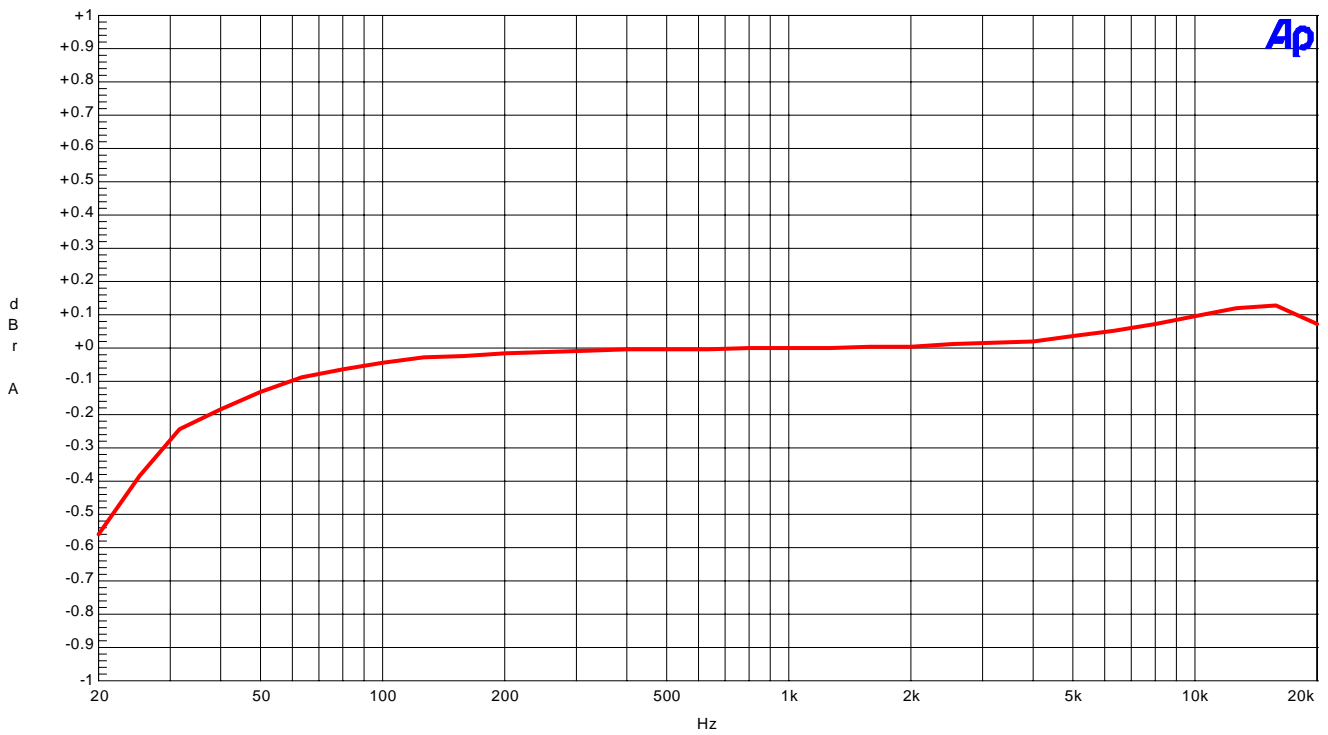

Frequency Response (Input Level=0dBFS)

(fs=44.1kHz)

AK4394 Crosstalk

AKM

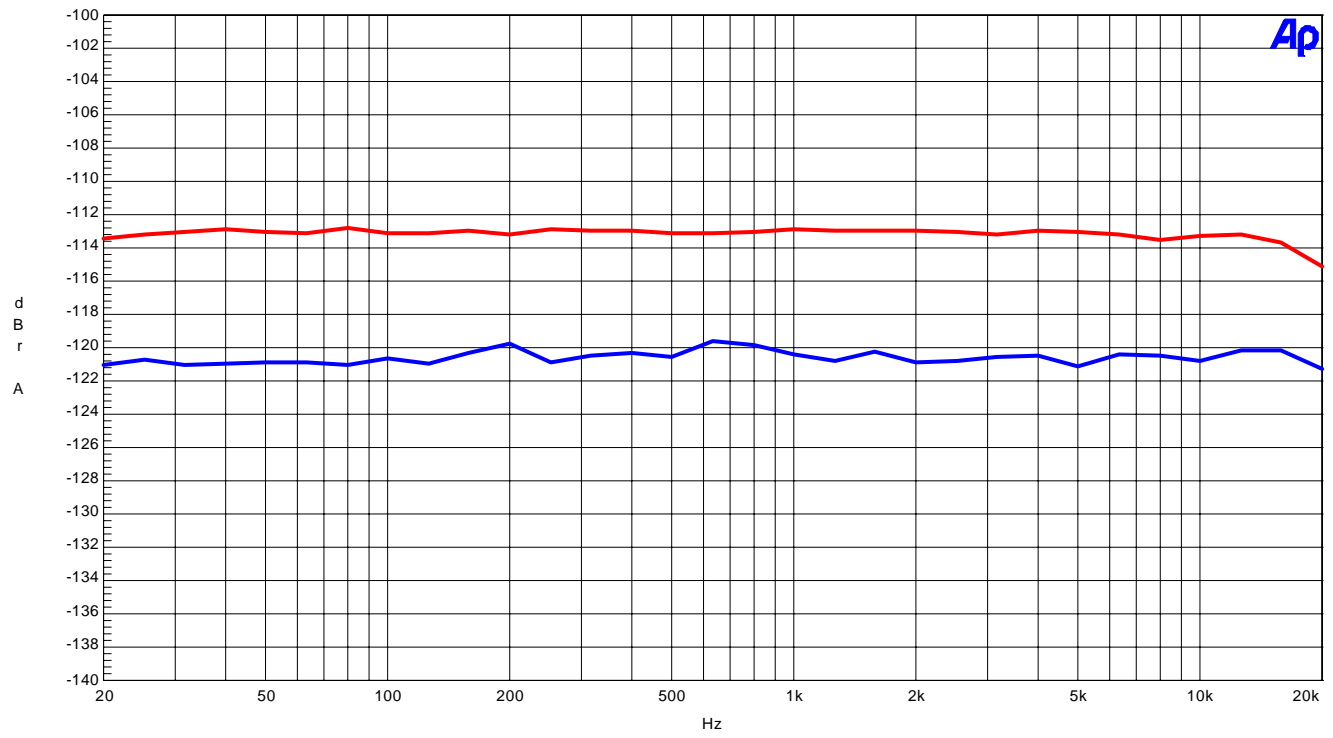

Crosstalk (upper = Rch, Lower = Lch)

(fs=96kHz)  
AKM AK4394 FFT (Input Level=0dBFS, fin=1kHz, Notch)

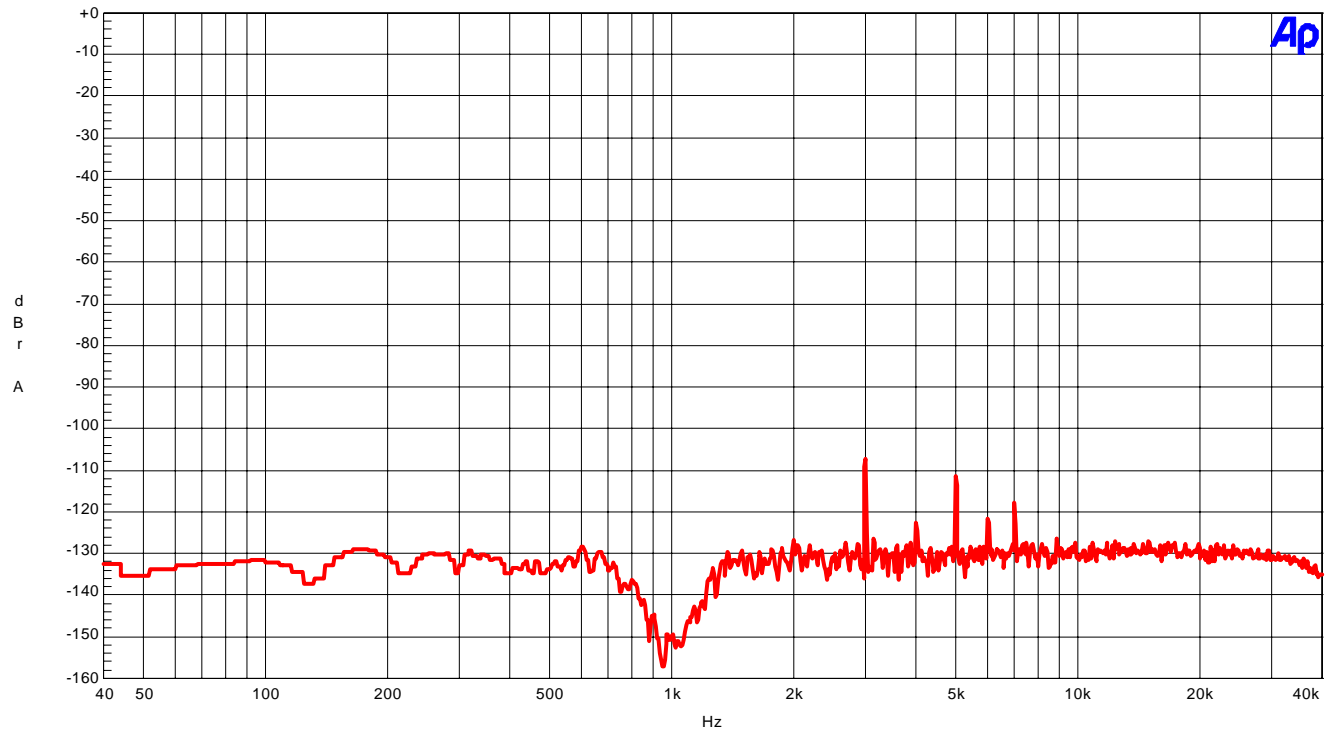

FFT (Input Level=0dBFS, fin=1kHz, notch)  
AKM AK4394 FFT (Input Level=-60dBFS, fin=1kHz)

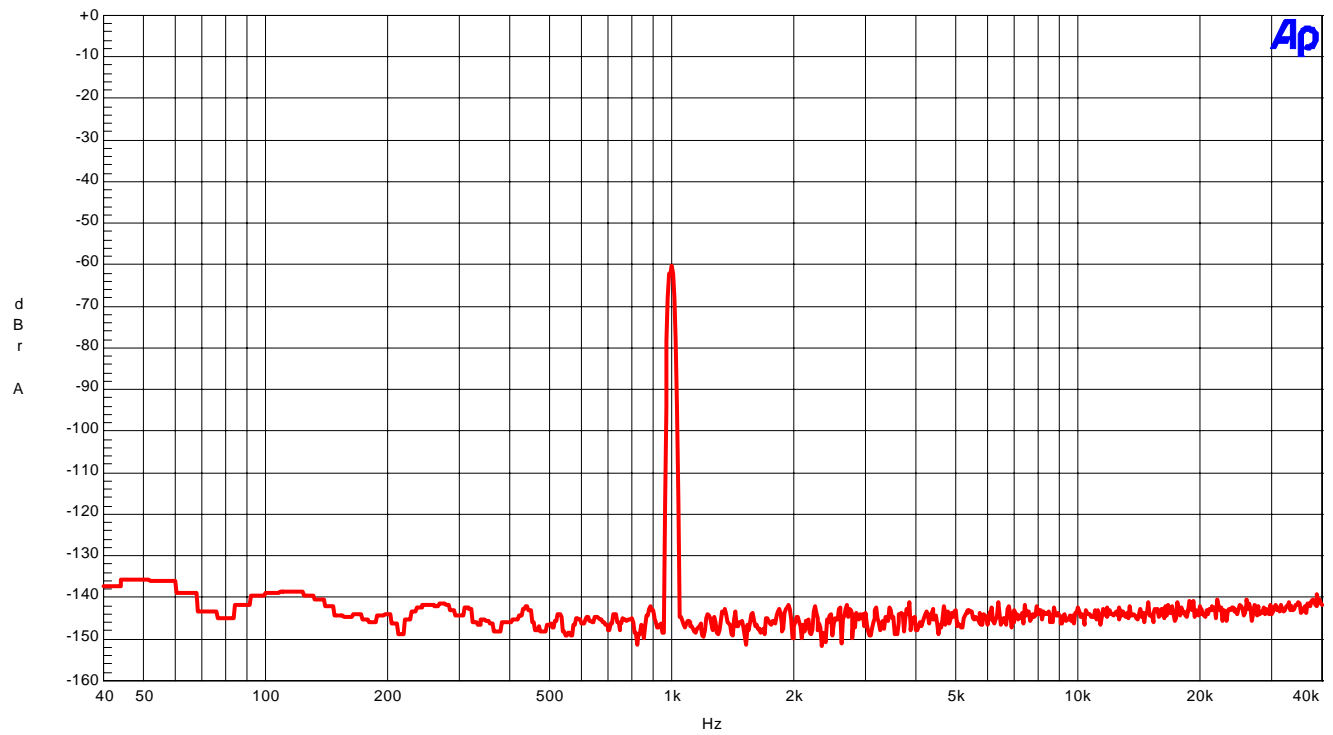

FFT (Input Level=-60dBFS, fin=1kHz)

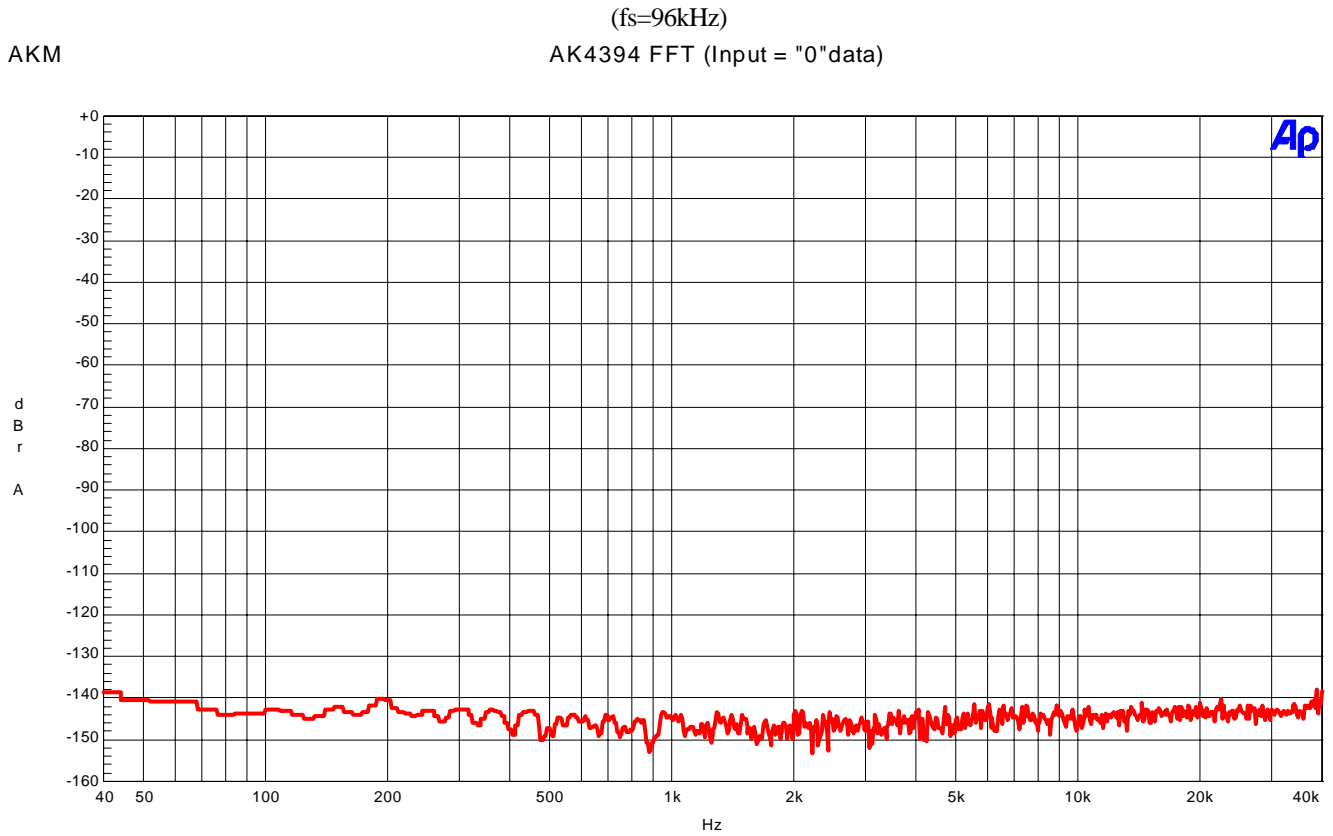

FFT (noise floor)

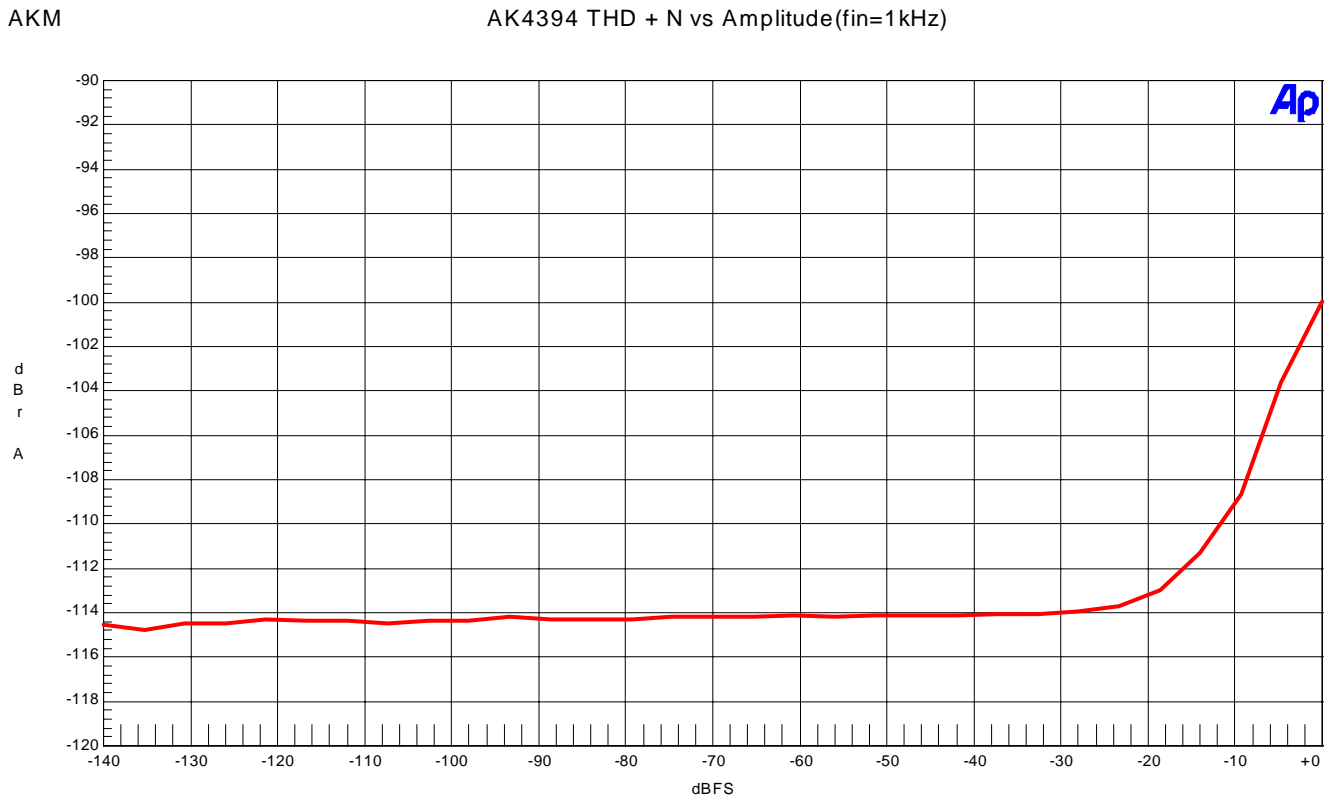

THD + N vs Amplitude (fin=1kHz)



(fs=96kHz)

AKM

AK4394 THD + N vs Input Frequency(Input Level=0dBFS)

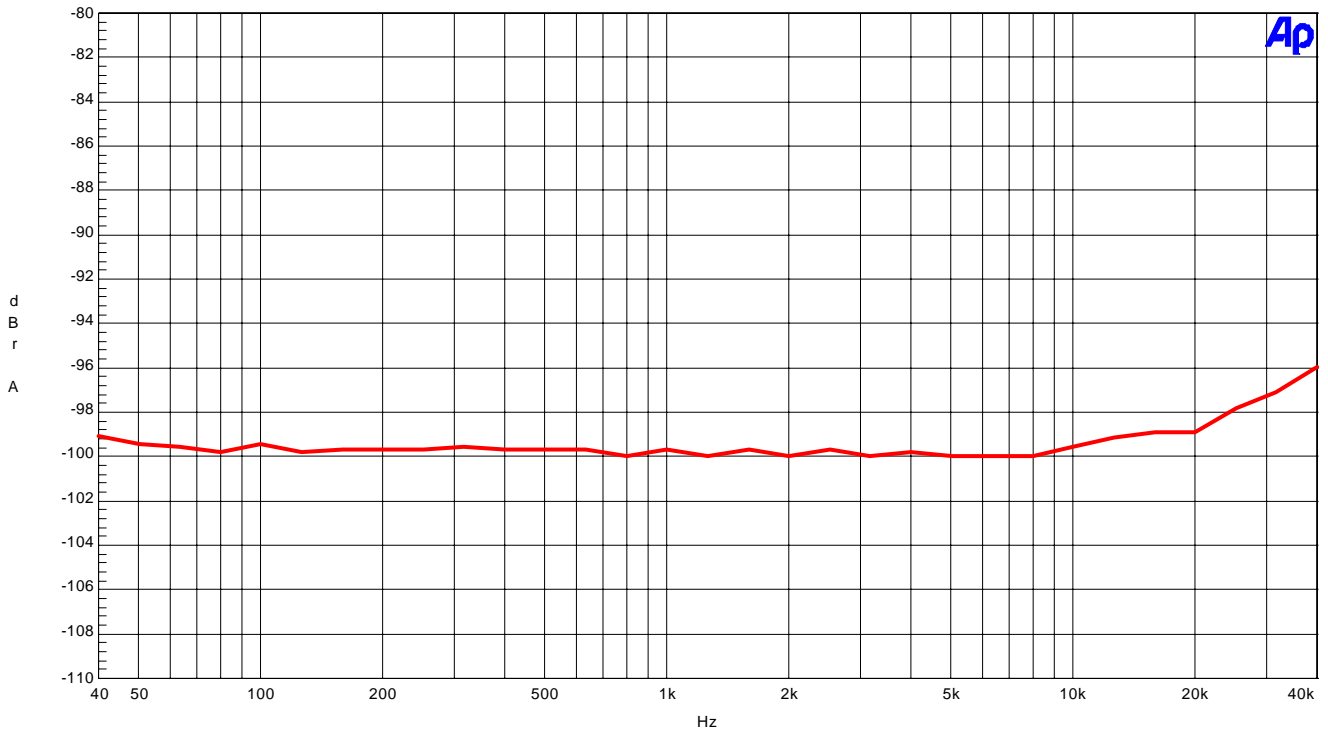

THD + N vs Input Frequency (Input Level=0dBFS)

AKM

AK4394 Linearity

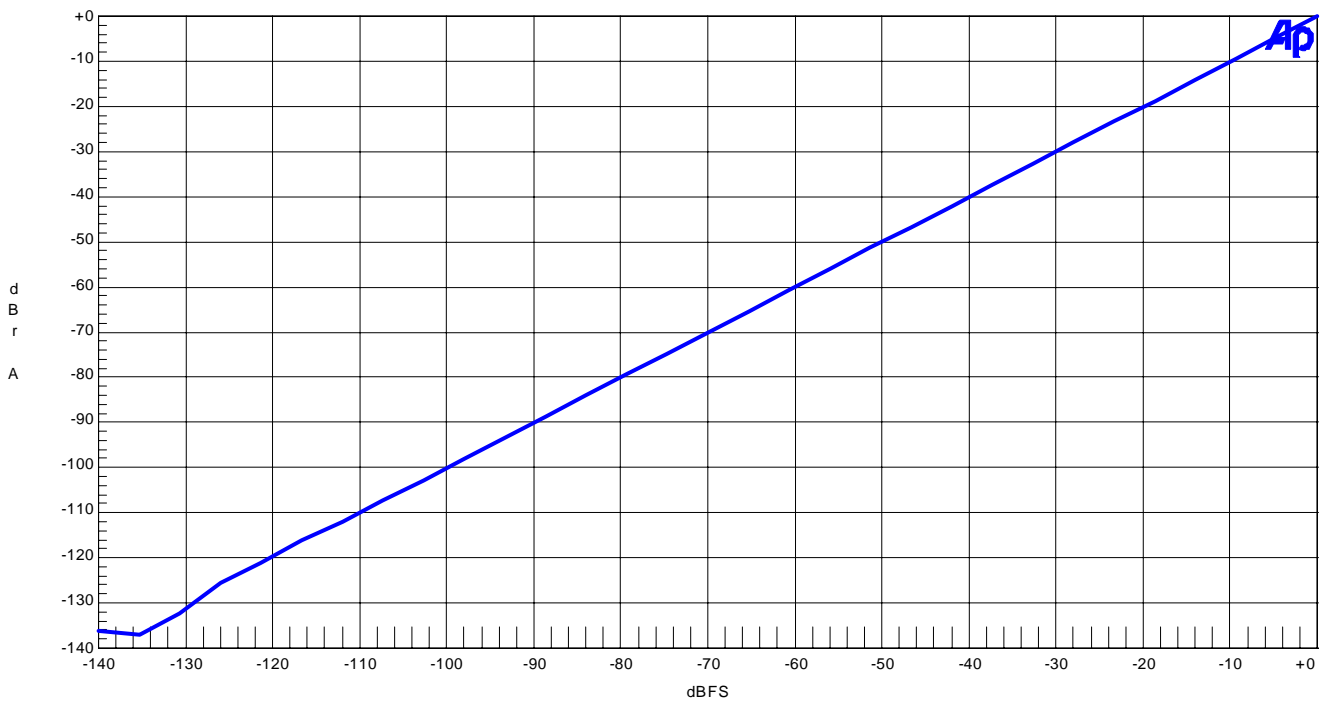

Linearity (fin=1kHz)

(fs=96kHz)

AKM

AK4394 Frequency Response

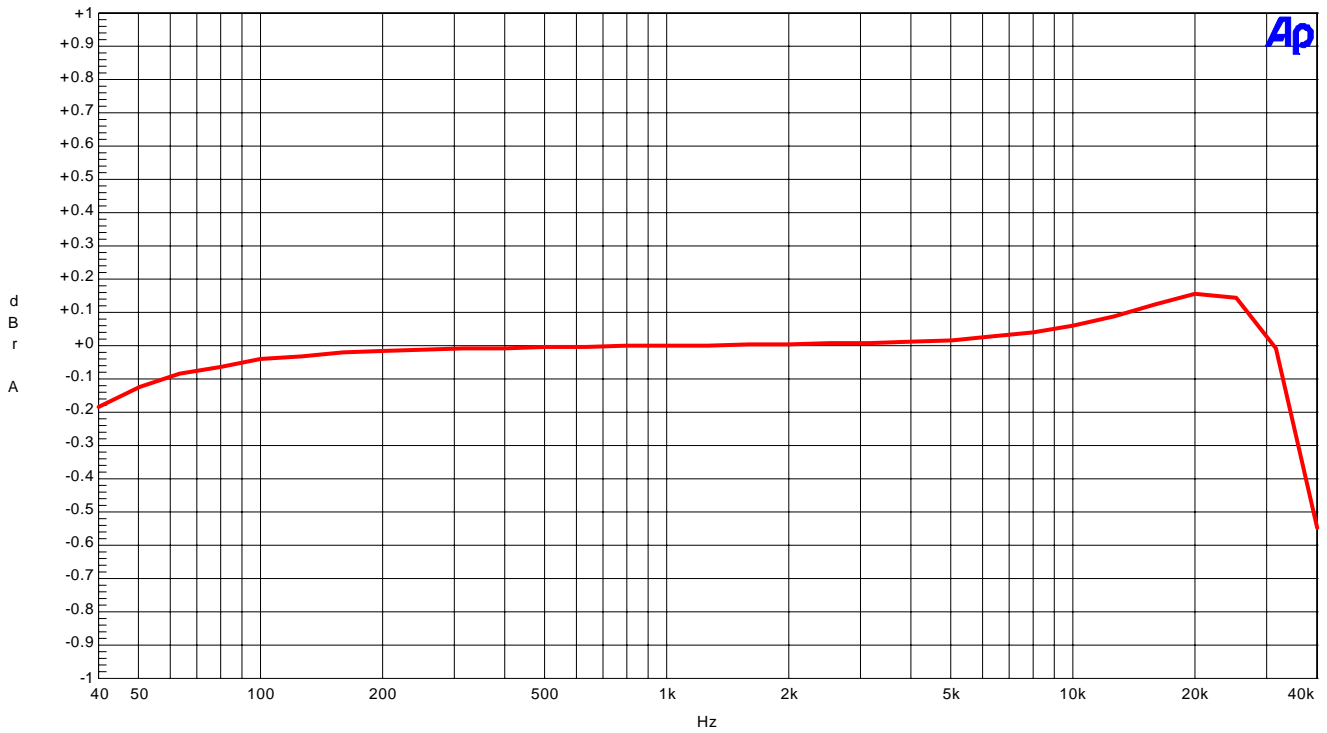

Frequency Response (Input Level=0dBFS)

AKM

AK4394 Crosstalk

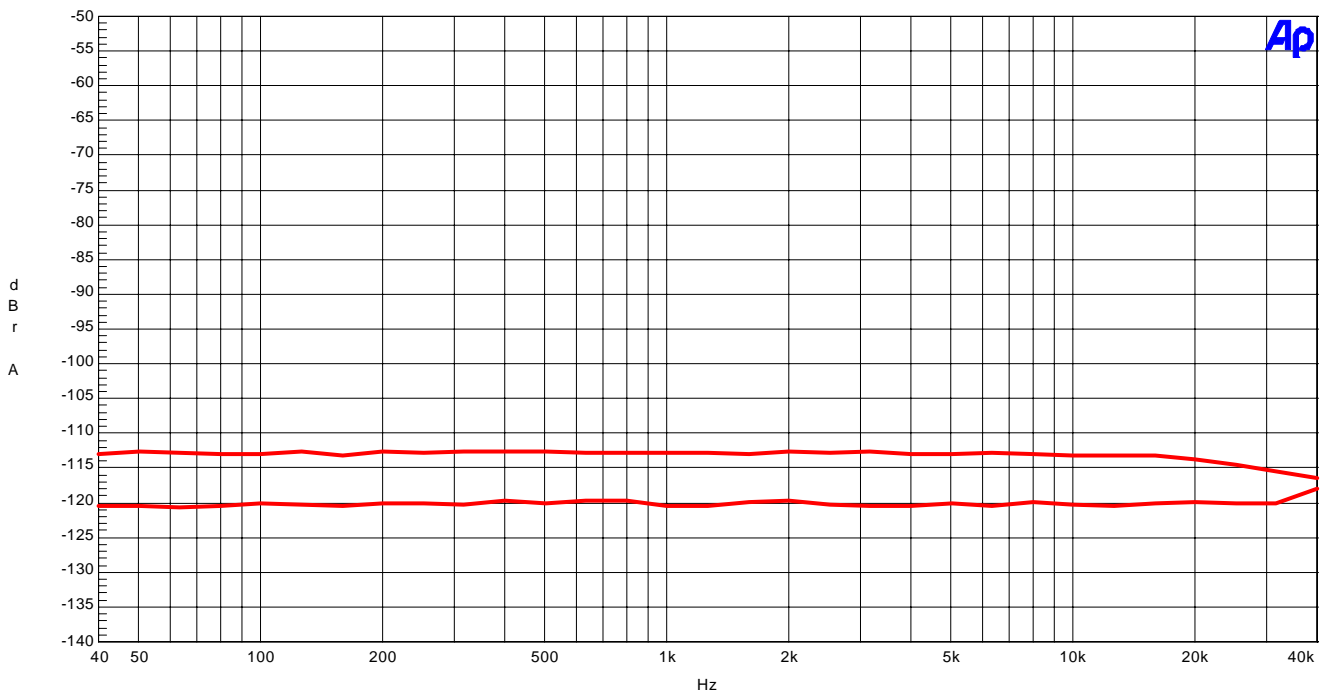

Crosstalk (upper = Rch, Lower = Lch)

<b>Revision History</b>
-------------------------

Date (YY/MM/DD)	Manual Revision	Board Revision	Reason	Contents
07/01/23	KM063002	C	Control Soft Manual	Control Soft Manual addition

IMPORTANT NOTICE

- These products and their specifications are subject to change without notice. Before considering any use or application, consult the Asahi Kasei Microsystems Co., Ltd. (AKM) sales office or authorized distributor concerning their current status.
- AKM assumes no liability for infringement of any patent, intellectual property, or other right in the application or use of any information contained herein.
- Any export of these products, or devices or systems containing them, may require an export license or other official approval under the law and regulations of the country of export pertaining to customs and tariffs, currency exchange, or strategic materials.
- AKM products are neither intended nor authorized for use as critical components in any safety, life support, or other hazard related device or system, and AKM assumes no responsibility relating to any such use, except with the express written consent of the Representative Director of AKM. As used here:
  - (a) A hazard related device or system is one designed or intended for life support or maintenance of safety or for applications in medicine, aerospace, nuclear energy, or other fields, in which its failure to function or perform may reasonably be expected to result in loss of life or in significant injury or damage to person or property.
  - (b) A critical component is one whose failure to function or perform may reasonably be expected to result, whether directly or indirectly, in the loss of the safety or effectiveness of the device or system containing it, and which must therefore meet very high standards of performance and reliability.
- It is the responsibility of the buyer or distributor of an AKM product who distributes, disposes of, or otherwise places the product with a third party to notify that party in advance of the above content and conditions, and the buyer or distributor agrees to assume any and all responsibility and liability for and hold AKM harmless from any and all claims arising from the use of said product in the absence of such notification.

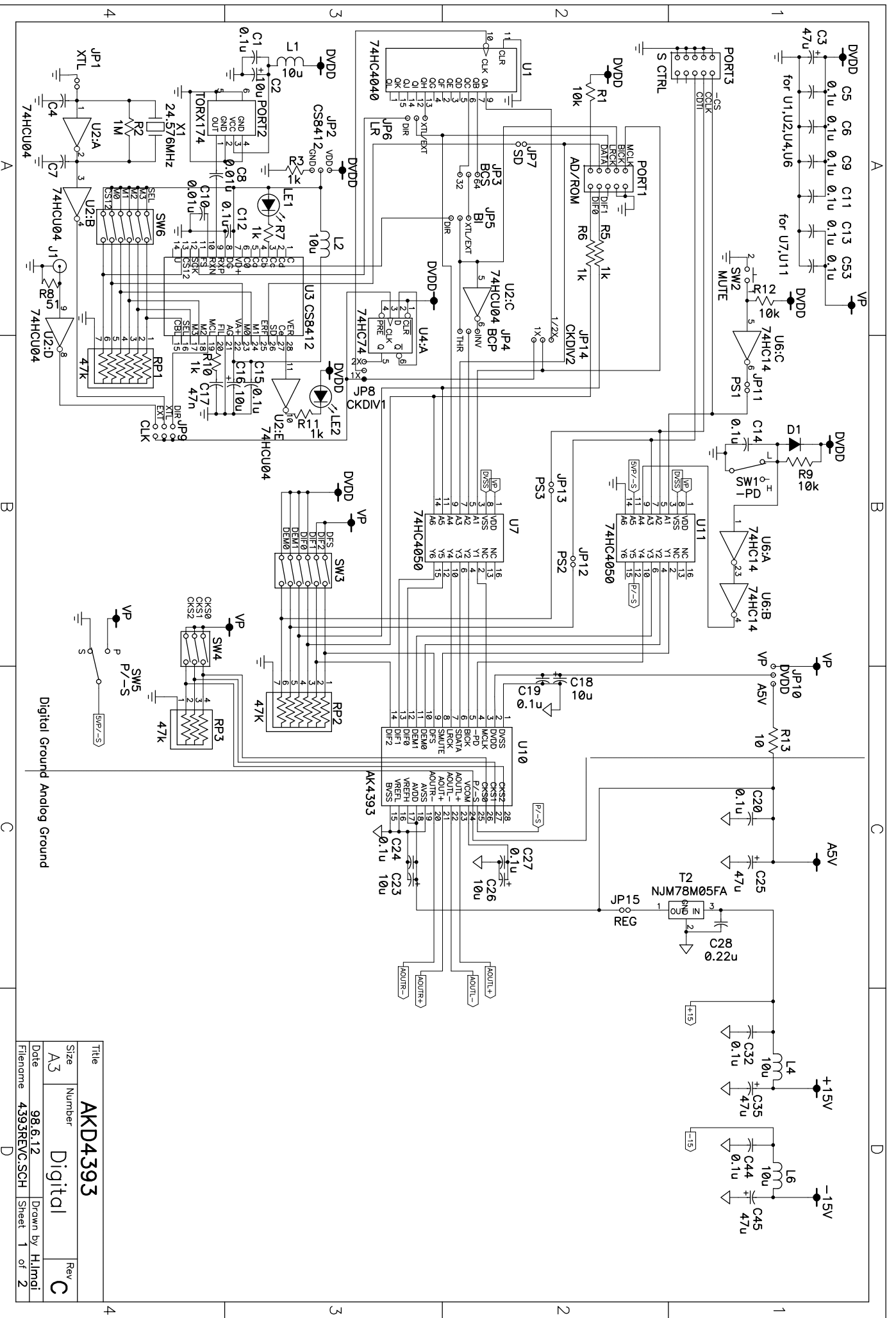

Digital Ground Analog Ground

Title		AKD4393	
Size	Number	Digital	
A3	98.6.12	Rev C	
Date	98.6.12	Drawn by H.Imoi	
Filename	4393REV.CSCH	Sheet 1 of 2	

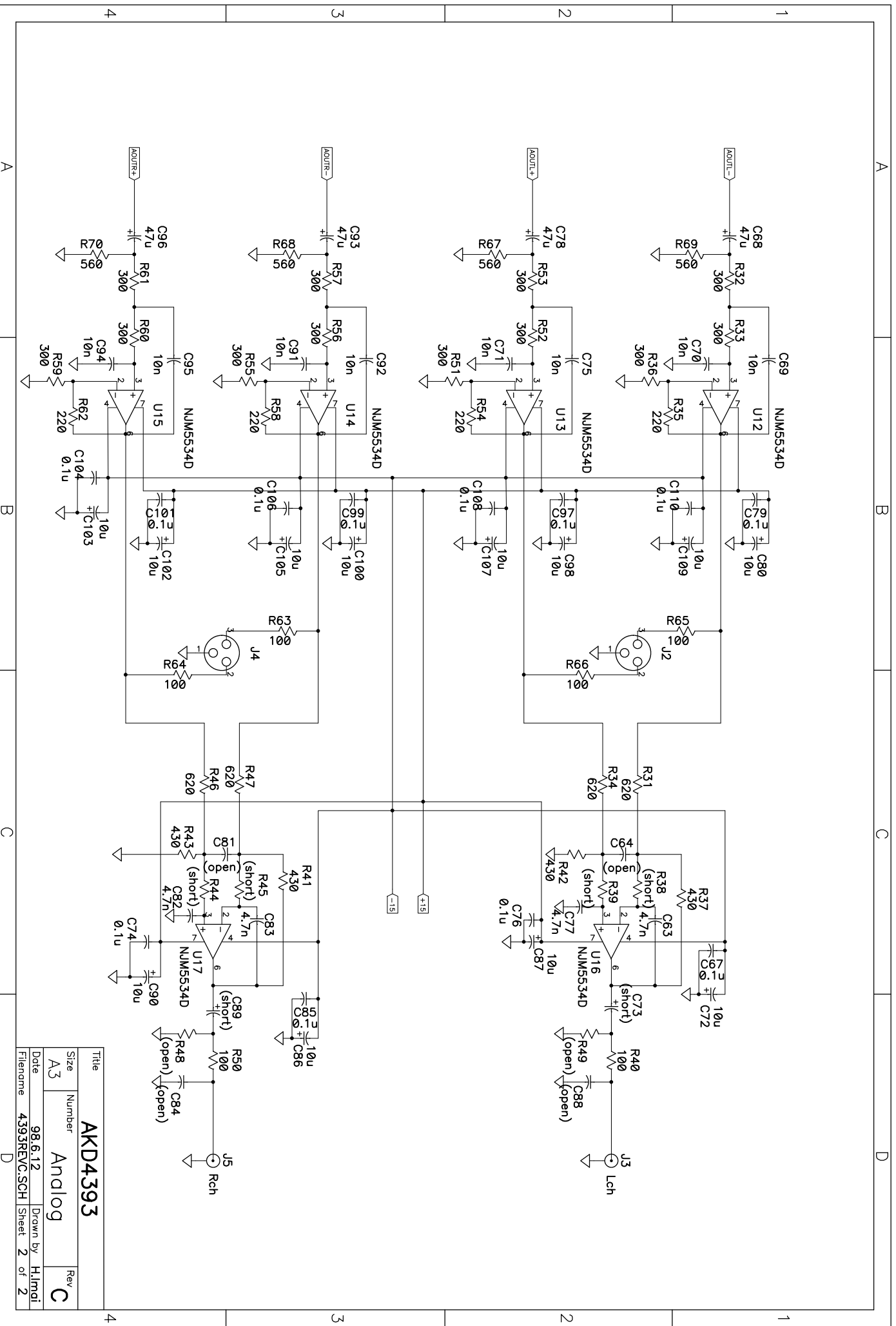

Title		AKD4393	
Size	Number	Analog	
A3			
Date	98.6.12	Drawn by	H.Imnai
Filename	4393REV.CSCH	Sheet	2 of 2

Rev C

2



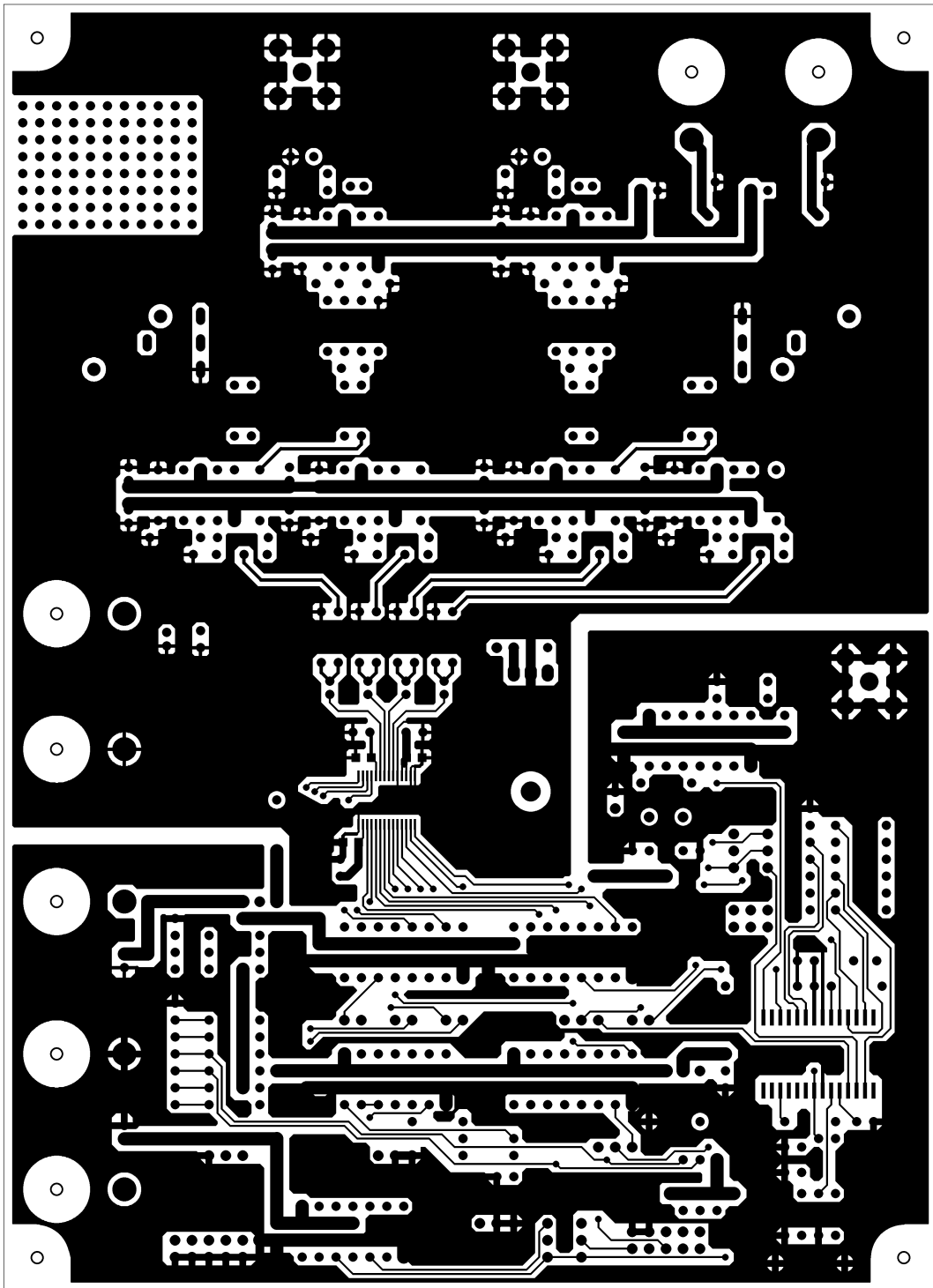

4393C L1

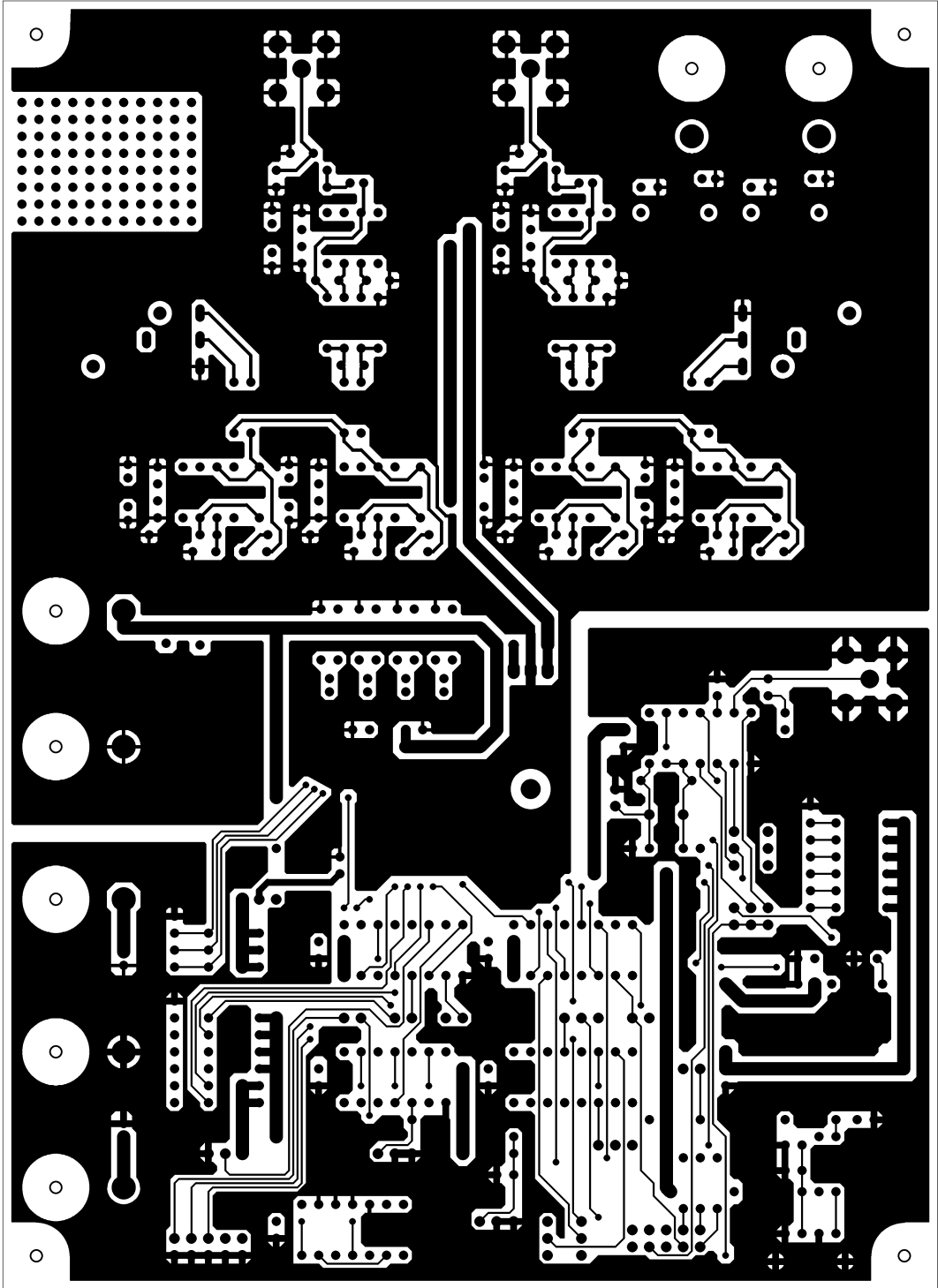

4333C TS