



DATA SHEET

ER300~ER306

SUPERFAST RECOVERY RECTIFIERS

VOLTAGE 50 to 600 Volts **CURRENT** 3.0 Ampere

DO-201AD Unit: inch(mm)

FEATURES

- Superfast recovery times-epitaxial construction.
- Low forward voltage, high current capability.
- Exceeds environmental standards of MIL-S-19500/228.
- Hermetically sealed.
- Low leakage.
- High surge capability.
- Plastic package has Underwriters Laboratories Flammability Classification 94V-O utilizing Flame Retardant Epoxy Molding Compound.
- Pb free product are available : 99% Sn above can meet Rohs environment substance directive request

MECHANICAL DATA

Case: Molded plastic, DO-201AD
 Terminals: Axial leads, solderable to MIL-STD-202, Method 208
 Polarity: Color Band denotes cathode end
 Mounting Position: Any
 Weight: 0.04 ounce, 1.12 gram

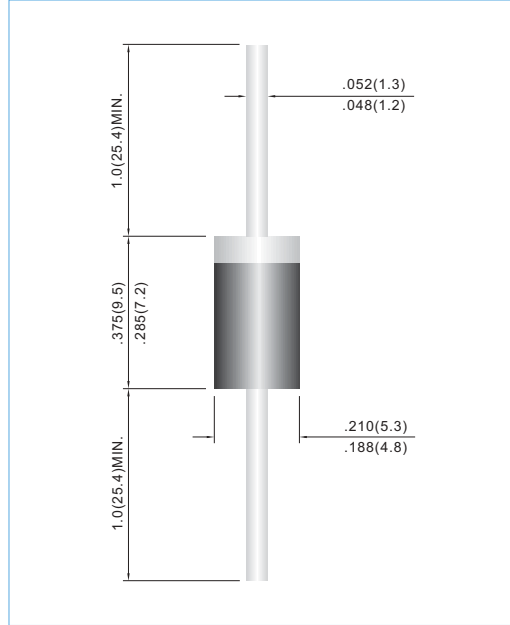

MAXIMUM RATINGS AND ELECTRICAL CHARACTERISTICS

Ratings at 25°C ambient temperature unless otherwise specified.
 Resistive or inductive load, 60Hz.

PARAMETER	SYMBOL	ER300	ER301	ER301A	ER302	ER303	ER304	ER306	UNITS
Maximum Recurrent Peak Reverse Voltage	V _{RRM}	50	100	150	200	300	400	600	V
Maximum RMS Voltage	V _{RMS}	35	70	105	140	210	280	420	V
Maximum DC Blocking Voltage	V _{DC}	50	100	150	200	300	400	600	V
Maximum Average Forward Current .375"(9.5mm) lead length at T _A =55°C	I _{AV}	3.0							A
Peak Forward Surge Current :8.3ms single half sine-wave superimposed on rated load(JEDEC method)	I _{FSM}	125							A
Maximum Forward Voltage at 3.0A DC	V _F	0.95				1.25		1.70	V
Maximum DC Reverse Current at T _A =25°C Rated DC Blocking Voltage T _A =125°C	I _R					5.0 300			uA
Maximum Reverse Recovery Time(Note 1)	T _{RR}					35			ns
Typical Junction capacitance (Note 2)	C _J					35			pF
Typical Junction Resistance(Note 3)	R _{θJA}					20			°C / W
Operating and Storage Temperature Range T _J , T _{STG}	T _J , T _{STG}	-55 TO +150							°C

NOTES: 1. Reverse Recovery Test Conditions: I_F=.5A, I_R=1A, I_{rr}=.25A
 2. Measured at 1 MHz and applied reverse voltage of 4.0 VDC
 3. Thermal resistance from junction to ambient and from junction to lead length 0.375"(9.5mm) P.C.B. mounted



RATING AND CHARACTERISTIC CURVES

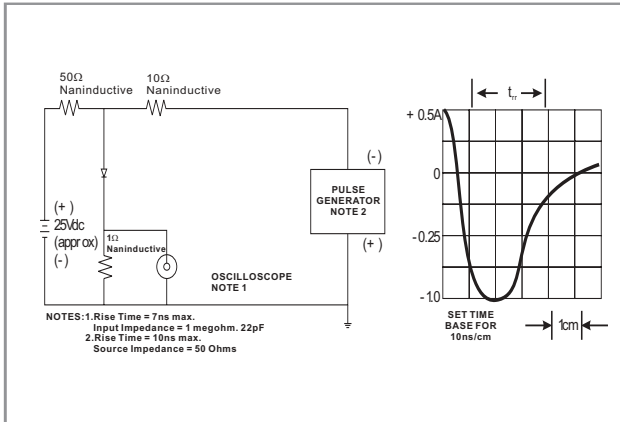

FIG.1 REVERSE RECOVERY TIME CHARACTERISTIC AND TEST CIRCUIT DIAGRAM

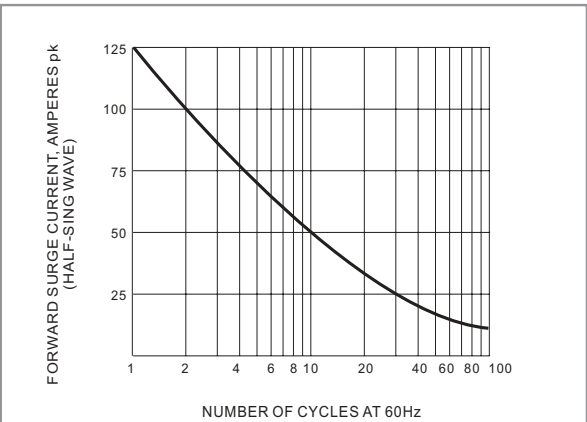

FIG.2 MAXIMUM NON-REPEITIVE SURGE CURRENT

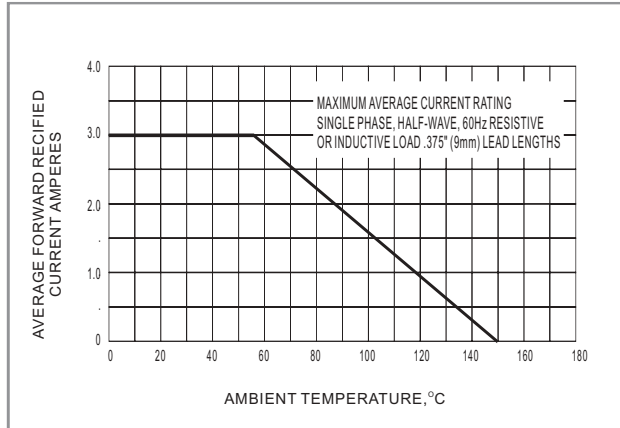

FIG.3 MAXIMUM AVERAGE FORWARD CURRENT RATING

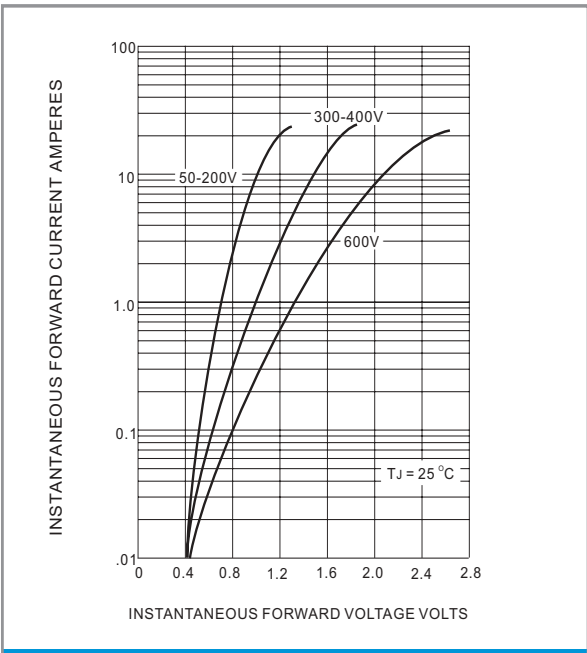

FIG.4 TYPICAL JUNCTION CAPACITANCE

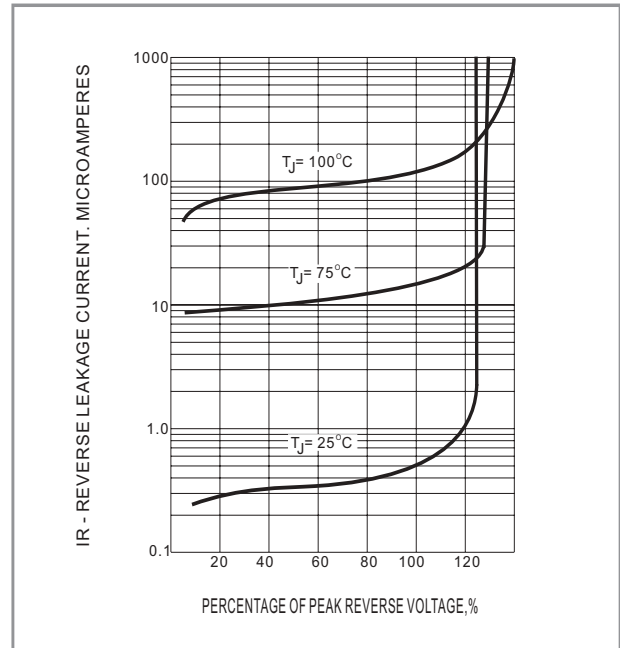

FIG.5 TYPICAL REVERSE CHARACTERISTICS

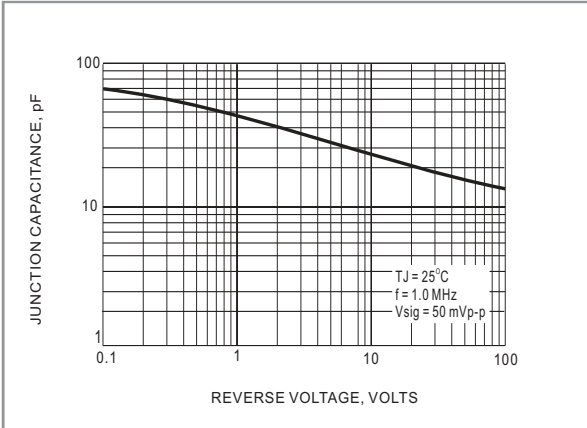

FIG.6 TYPICAL JUNCTION CAPACITANCE