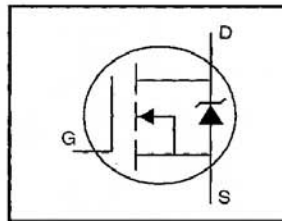


# IRF630SPbF

## HEXFET® Power MOSFET

- Surface Mount
- Available in Tape & Reel
- Dynamic dv/dt Rating
- Repetitive Avalanche Rated
- Fast Switching
- Ease of Paralleling
- Simple Drive Requirements
- Lead-Free

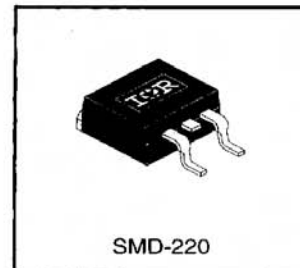


$V_{DSS} = 200V$
$R_{DS(on)} = 0.40\Omega$
$I_D = 9.0A$

### Description

Third Generation HEXFETs from International Rectifier provide the designer with the best combination of fast switching, ruggedized device design, low on-resistance and cost-effectiveness.

The SMD-220 is a surface mount power package capable of accommodating die sizes up to HEX-4. It provides the highest power capability and the lowest possible on-resistance in any existing surface mount package. The SMD-220 is suitable for high current applications because of its low internal connection resistance and can dissipate up to 2.0W in a typical surface mount application.



### Absolute Maximum Ratings

	Parameter	Max.	Units
$I_D @ T_C = 25^\circ C$	Continuous Drain Current, $V_{GS} @ 10 V$	9.0	A
$I_D @ T_C = 100^\circ C$	Continuous Drain Current, $V_{GS} @ 10 V$	5.7	
$I_{DM}$	Pulsed Drain Current ①	36	
$P_D @ T_C = 25^\circ C$	Power Dissipation	74	W
$P_D @ T_A = 25^\circ C$	Power Dissipation (PCB Mount)**	3.0	
	Linear Derating Factor	0.59	W/°C
	Linear Derating Factor (PCB Mount)**	0.025	
$V_{GS}$	Gate-to-Source Voltage	$\pm 20$	V
$E_{AS}$	Single Pulse Avalanche Energy ②	250	mJ
$I_{AR}$	Avalanche Current ①	9.0	A
$E_{AR}$	Repetitive Avalanche Energy ①	7.4	mJ
dv/dt	Peak Diode Recovery dv/dt ③	5.0	V/ns
$T_J, T_{STG}$	Junction and Storage Temperature Range	-55 to +150	°C
	Soldering Temperature, for 10 seconds	300 (1.6mm from case)	


### Thermal Resistance

	Parameter	Min.	Typ.	Max.	Units
$R_{\theta JC}$	Junction-to-Case	—	—	1.7	°C/W
$R_{\theta JA}$	Junction-to-Ambient (PCB mount)**	—	—	40	
$R_{\theta JA}$	Junction-to-Ambient	—	—	62	


\*\* When mounted on 1" square PCB (FR-4 or G-10 Material).

For recommended footprint and soldering techniques refer to application note #AN-994.

### Electrical Characteristics @ T<sub>J</sub> = 25°C (unless otherwise specified)

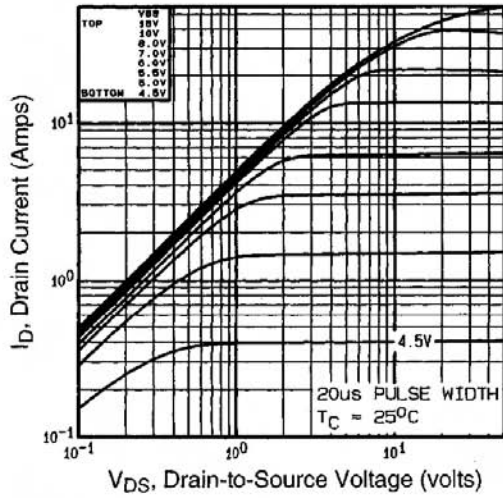
Parameter	Parameter	Min.	Typ.	Max.	Units	Test Conditions
V <sub>(BR)DSS</sub>	Drain-to-Source Breakdown Voltage	200	—	—	V	V <sub>GS</sub> =0V, I <sub>D</sub> =250μA
ΔV <sub>(BR)DSS/ΔT<sub>J</sub></sub>	Breakdown Voltage Temp. Coefficient	—	0.24	—	V/°C	Reference to 25°C, I <sub>D</sub> =1mA
R <sub>DS(on)</sub>	Static Drain-to-Source On-Resistance	—	—	0.40	Ω	V <sub>GS</sub> =10V, I <sub>D</sub> =5.4A ④
V <sub>GS(th)</sub>	Gate Threshold Voltage	2.0	—	4.0	V	V <sub>DS</sub> =V <sub>GS</sub> , I <sub>D</sub> =250μA
g <sub>fs</sub>	Forward Transconductance	3.8	—	—	S	V <sub>DS</sub> =50V, I <sub>D</sub> =5.4A ④
I <sub>DSS</sub>	Drain-to-Source Leakage Current	—	—	25	μA	V <sub>DS</sub> =200V, V <sub>GS</sub> =0V
		—	—	250		V <sub>DS</sub> =160V, V <sub>GS</sub> =0V, T <sub>J</sub> =125°C
I <sub>GSS</sub>	Gate-to-Source Forward Leakage	—	—	100	nA	V <sub>GS</sub> =20V
	Gate-to-Source Reverse Leakage	—	—	-100		V <sub>GS</sub> =-20V
Q <sub>g</sub>	Total Gate Charge	—	—	43	nC	I <sub>D</sub> =5.9A
Q <sub>gs</sub>	Gate-to-Source Charge	—	—	7.0		V <sub>DS</sub> =160V
Q <sub>gd</sub>	Gate-to-Drain ("Miller") Charge	—	—	23		V <sub>GS</sub> =10V See Fig. 6 and 13 ④
t <sub>d(on)</sub>	Turn-On Delay Time	—	9.4	—	ns	V <sub>DD</sub> =100V
t <sub>r</sub>	Rise Time	—	28	—		I <sub>D</sub> =5.9A
t <sub>d(off)</sub>	Turn-Off Delay Time	—	39	—		R <sub>G</sub> =12Ω
t <sub>f</sub>	Fall Time	—	20	—		R <sub>D</sub> =16Ω See Figure 10 ④
L <sub>D</sub>	Internal Drain Inductance	—	4.5	—	nH	Between lead, 6 mm (0.25in.) from package and center of die contact
L <sub>S</sub>	Internal Source Inductance	—	7.5	—		
C <sub>iss</sub>	Input Capacitance	—	800	—	pF	V <sub>GS</sub> =0V
C <sub>oss</sub>	Output Capacitance	—	240	—		V <sub>DS</sub> =25V
C <sub>rss</sub>	Reverse Transfer Capacitance	—	76	—		f=1.0MHz See Figure 5

### Source-Drain Ratings and Characteristics

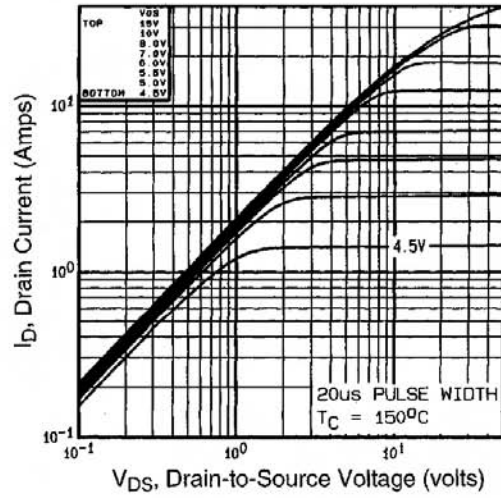
Parameter	Parameter	Min.	Typ.	Max.	Units	Test Conditions
I <sub>S</sub>	Continuous Source Current (Body Diode)	—	—	9.0	A	MOSFET symbol showing the integral reverse p-n junction diode. 
I <sub>SM</sub>	Pulsed Source Current (Body Diode) ①	—	—	36		
V <sub>SD</sub>	Diode Forward Voltage	—	—	2.0	V	T <sub>J</sub> =25°C, I <sub>S</sub> =9.0A, V <sub>GS</sub> =0V ④
t <sub>rr</sub>	Reverse Recovery Time	—	170	340	ns	T <sub>J</sub> =25°C, I <sub>F</sub> =5.9A
Q <sub>rr</sub>	Reverse Recovery Charge	—	1.1	2.2	μC	di/dt=100A/μs ④
t <sub>on</sub>	Forward Turn-On Time	Intrinsic turn-on time is negligible (turn-on is dominated by L <sub>S</sub> +L <sub>D</sub> )				

#### Notes:

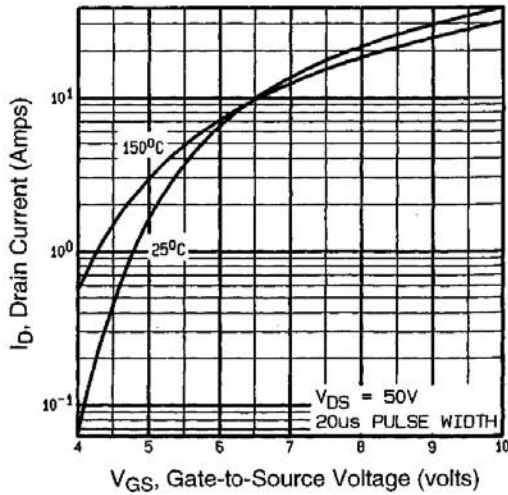
- ① Repetitive rating; pulse width limited by max. junction temperature (See Figure 11)
- ② V<sub>DD</sub>=50V, starting T<sub>J</sub>=25°C, L=4.6mH, R<sub>G</sub>=25Ω, I<sub>AS</sub>=9.0A (See Figure 12)
- ③ I<sub>SD</sub>≤9.0A, di/dt≤120A/μs, V<sub>DD</sub>≤V<sub>(BR)DSS</sub>, T<sub>J</sub>≤150°C
- ④ Pulse width ≤ 300 μs; duty cycle ≤2%.



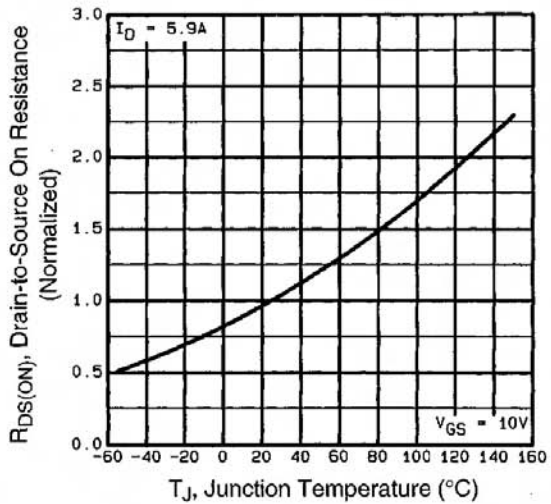
**Fig 1.** Typical Output Characteristics,  
 $T_C=25^\circ\text{C}$



**Fig 2.** Typical Output Characteristics,  
 $T_C=150^\circ\text{C}$

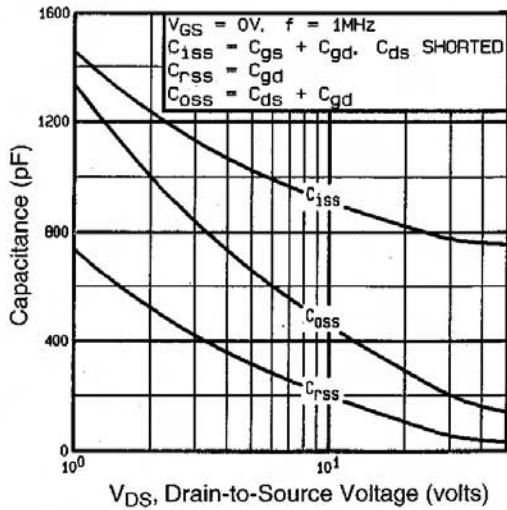


**Fig 3.** Typical Transfer Characteristics

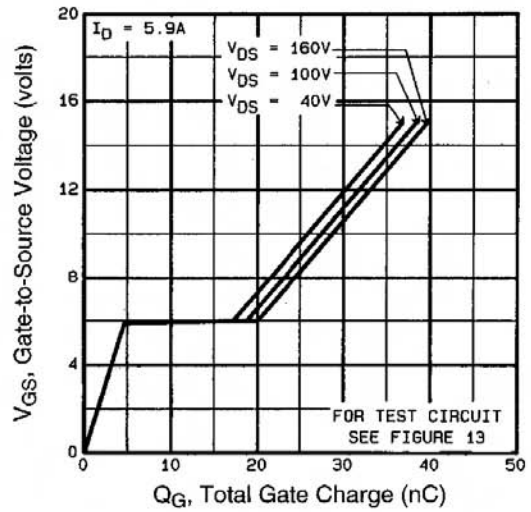


**Fig 4.** Normalized On-Resistance  
 Vs. Temperature

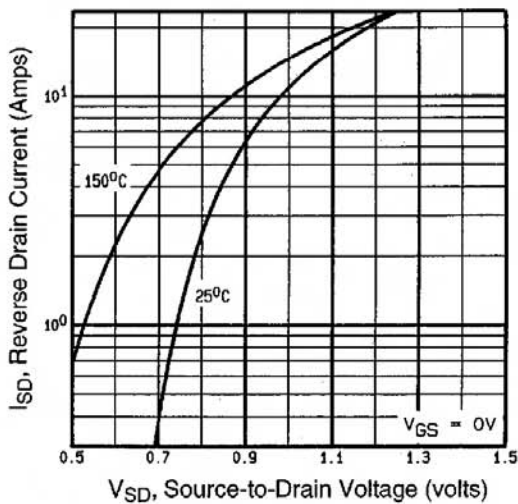




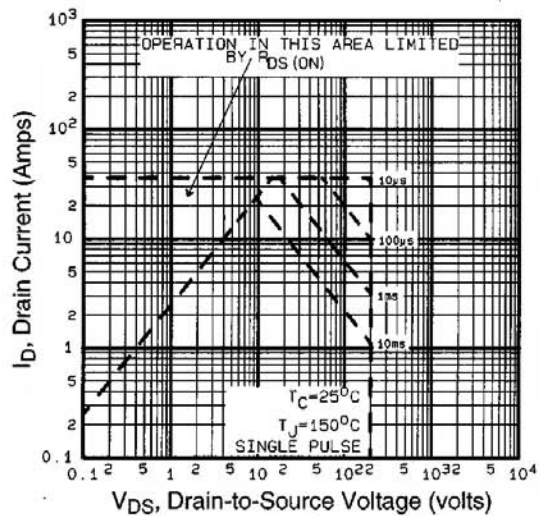
**Fig 5.** Typical Capacitance Vs. Drain-to-Source Voltage



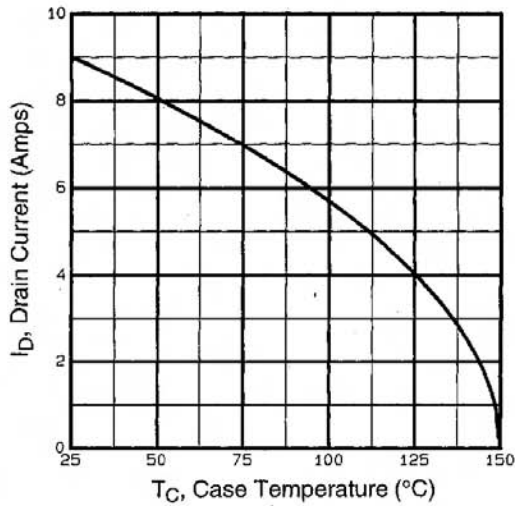
**Fig 6.** Typical Gate Charge Vs. Gate-to-Source Voltage



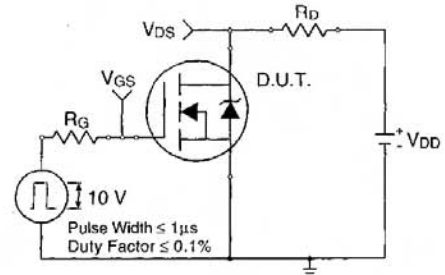
**Fig 7.** Typical Source-Drain Diode Forward Voltage



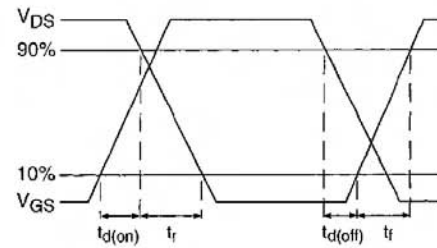
**Fig 8.** Maximum Safe Operating Area



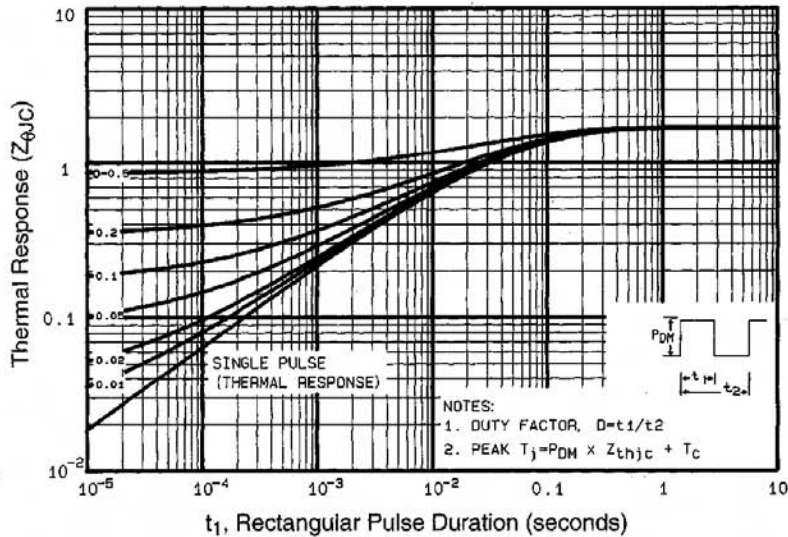
**Fig 9.** Maximum Drain Current Vs. Case Temperature



**Fig 10a.** Switching Time Test Circuit



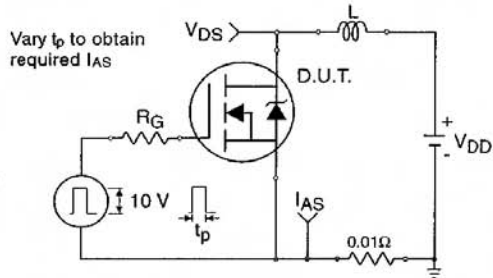
**Fig 10b.** Switching Time Waveforms



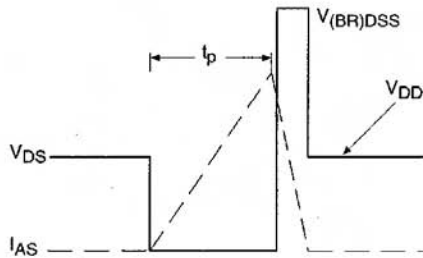
**Fig 11.** Maximum Effective Transient Thermal Impedance, Junction-to-Case

# IRF630SPbF

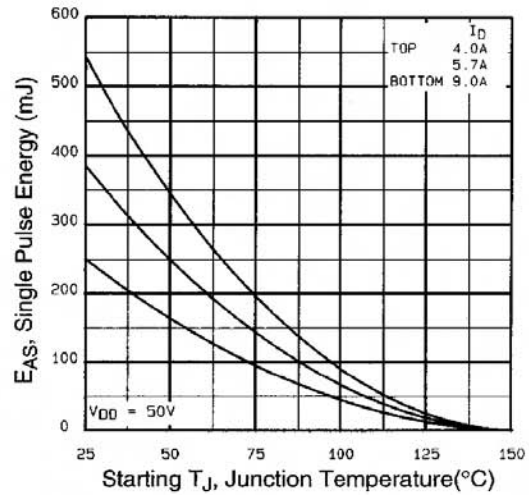
International  
**IR** Rectifier



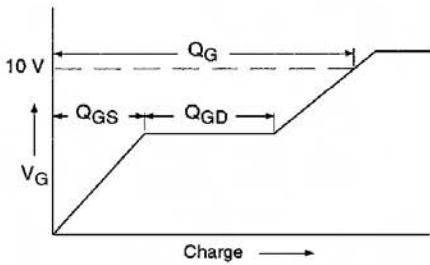
**Fig 12a.** Unclamped Inductive Test Circuit



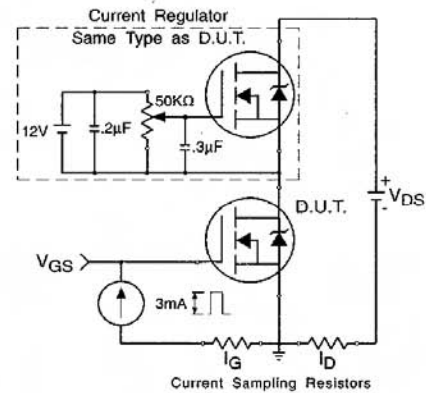
**Fig 12b.** Unclamped Inductive Waveforms



**Fig 12c.** Maximum Avalanche Energy Vs. Drain Current



**Fig 13a.** Basic Gate Charge Waveform



**Fig 13b.** Gate Charge Test Circuit

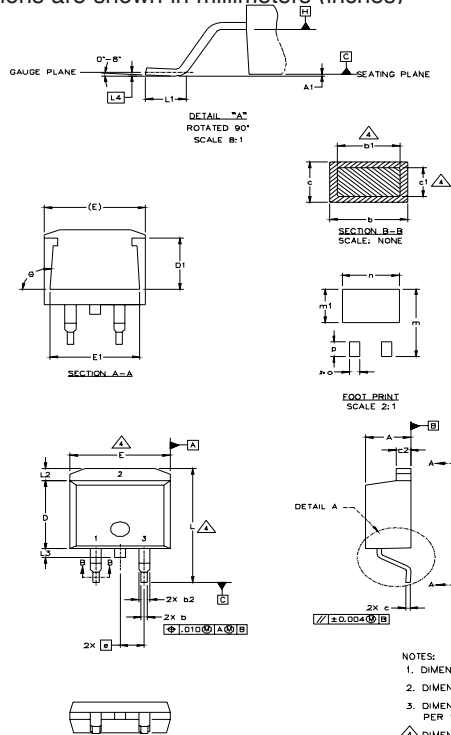
**Appendix A:** Figure 14, Peak Diode Recovery  $dv/dt$  Test Circuit – See page 1505

International  
**IR** Rectifier

www.irf.com

## D<sup>2</sup>Pak Package Outline

Dimensions are shown in millimeters (inches)



SYMBOL	DIMENSIONS				NOTES
	MILLIMETERS		INCHES		
	MIN.	MAX.	MIN.	MAX.	
A	4.06	4.83	.160	.190	4
A1		0.127		.005	
b	0.51	0.99	.020	.039	
b1	0.51	0.89	.020	.035	
b2	1.14	1.40	.045	.055	4
c	0.43	0.63	.017	.025	
c1	0.38	0.74	.015	.029	3
c2	1.14	1.40	.045	.055	
D	8.51	9.65	.335	.380	3
D1	5.33		.210		
E	9.65	10.67	.380	.420	3
E1	6.22		.245		
e	2.54 BSC		.100 BSC		
L	14.61	15.88	.575	.625	
L1	1.78	2.79	.070	.110	
L2		1.65		.065	
L3	1.27	1.78	.050	.070	
L4	0.25 BSC		.010 BSC		
m	17.78		.700		
m1	8.89		.350		
n	11.43		.450		
a	2.08		.082		
p	3.81		.150		
θ	90°	93°	90°	93°	

### LEAD ASSIGNMENTS

HEXFET	IGBTs, CoPACK	DIODES
1.- GATE	1.- GATE	1.- ANODE *
2.- DRAIN	2.- COLLECTOR	2.- CATHODE
3.- SOURCE	3.- EMITTER	3.- ANODE

\* PART DEPENDENT.

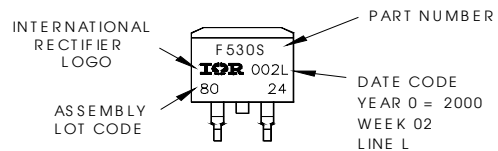
### NOTES:

1. DIMENSIONING AND TOLERANCING PER ASME Y14.5M-1994
2. DIMENSIONS ARE SHOWN IN MILLIMETERS [INCHES].
3. DIMENSION D & E DO NOT INCLUDE MOLD FLASH. MOLD FLASH SHALL NOT EXCEED 0.127 [ .005" ] PER SIDE. THESE DIMENSIONS ARE MEASURED AT THE OUTMOST EXTREMES OF THE PLASTIC BODY.
4. DIMENSION b1 AND c1 APPLY TO BASE METAL ONLY.
5. CONTROLLING DIMENSION: INCH.

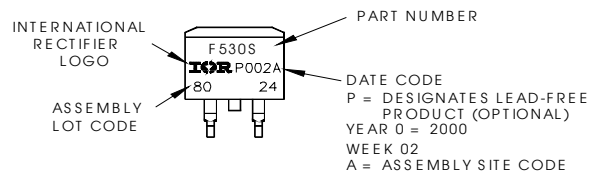
## D<sup>2</sup>Pak Part Marking Information (Lead-Free)

EXAMPLE: THIS IS AN IRF530S WITH  
LOT CODE 8024  
ASSEMBLED ON WW 02, 2000  
IN THE ASSEMBLY LINE "L"

Note: "P" in assembly line  
position indicates "Lead-Free"

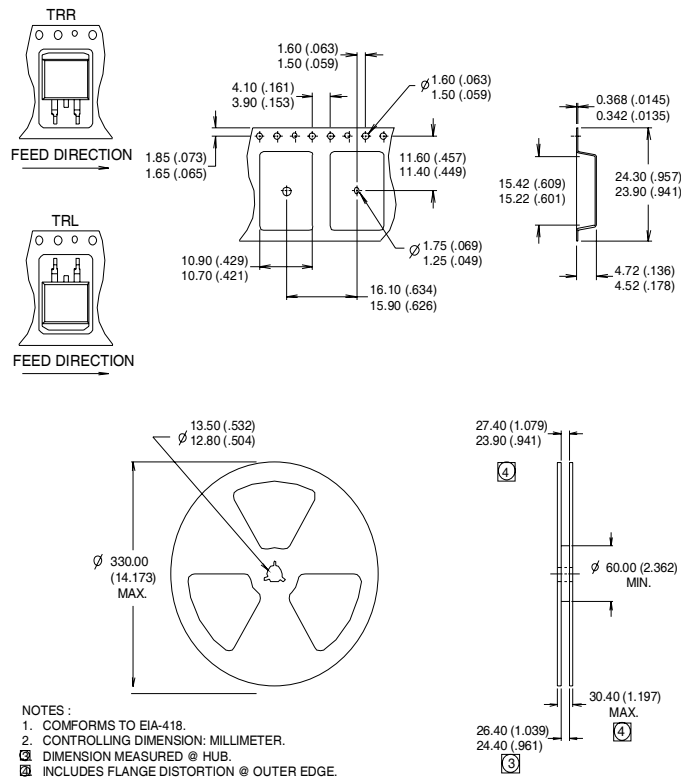


**OR**



## D<sup>2</sup>Pak Tape & Reel Information

Dimensions are shown in millimeters (inches)



Data and specifications subject to change without notice.

International  
**IR** Rectifier

**IR WORLD HEADQUARTERS:** 233 Kansas St., El Segundo, California 90245, USA Tel: (310) 252-7105  
TAC Fax: (310) 252-7903

Visit us at [www.irf.com](http://www.irf.com) for sales contact information.03/04

[www.irf.com](http://www.irf.com)