

TOSHIBA CMOS Digital Integrated Circuit Silicon Monolithic

# TC7WZ246FU, TC7WZ246FK

Dual Bus Transceiver  
Buffer And Buffer (Open Drain Outputs)

**Features**

- High output drive :  $\pm 24$  mA (min) at  $V_{CC} = 3$  V
- Super high speed operation :  $t_{pd} = 5.0$  ns(max)  
at  $V_{CC} = 5$  V, 50 pF
- Operation voltage range :  $V_{CC(opr)} = 1.65 \sim 5.5$  V
- 5.5-V tolerant inputs
- 5.5-V power down protection outputs
- Matches the performance of TC74LCX series when operated at 3.3-V  $V_{CC}$

Note : Do not apply a signal to any bus pins when it is in the output mode. Damage may result.

**Marking**

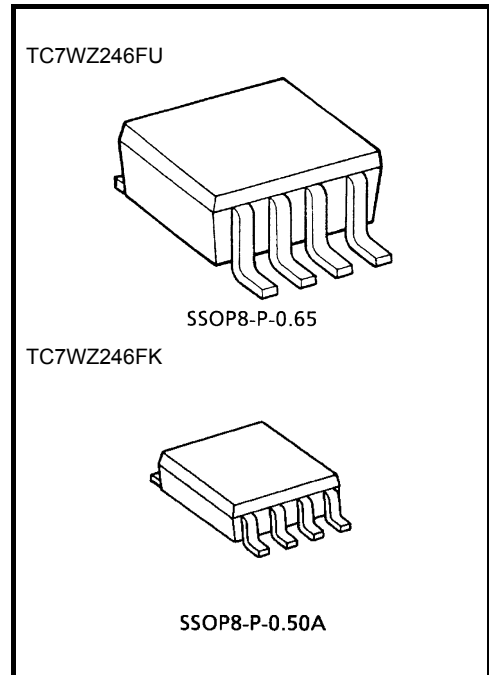
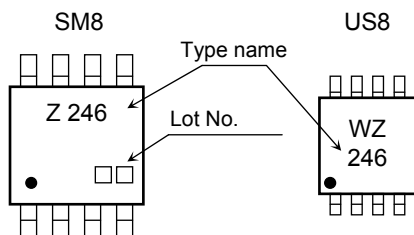

Weight  
 SSOP8-P-0.65 : 0.02 g (typ.)  
 SSOP8-P-0.50A : 0.01 g (typ.)

**Absolute Maximum Ratings (Ta = 25°C)**

Characteristics	Symbol	Rating	Unit
Supply voltage range	$V_{CC}$	-0.5~6	V
DC input voltage	$V_{IN}$	-0.5~6	V
DC output voltage	$V_{OUT}$	-0.5~6	V
Input diode current	$I_{IK}$	-20	mA
Output diode current	$I_{OK}$	-20	mA
DC output current	$I_{OUT}$	$\pm 50, +50$ (Note 1)	mA
DC $V_{CC}$ /ground current	$I_{CC}$	$\pm 50$	mA
Power dissipation	$P_D$	300 (SM8) 200 (US8)	mW
Storage temperature	$T_{stg}$	-65~150	°C
Lead temperature (10 s)	$T_L$	260	°C

**Pin Assignment (top view)**

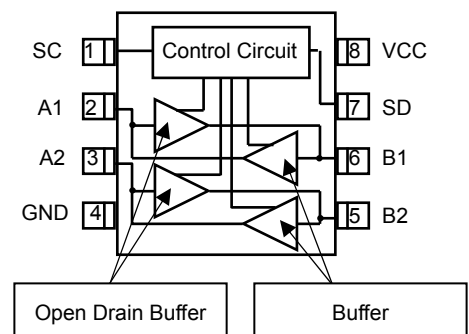

Note: Using continuously under heavy loads (e.g. the application of high temperature/current/voltage and the significant change in temperature, etc.) may cause this product to decrease in the reliability significantly even if the operating conditions (i.e. operating temperature/current/voltage, etc.) are within the absolute maximum ratings and the operating ranges.

Please design the appropriate reliability upon reviewing the Toshiba Semiconductor Reliability Handbook ("Handling Precautions"/Derating Concept and Methods) and individual reliability data (i.e. reliability test report and estimated failure rate, etc).

Note 1 : Open Drain Buffer Output diode current.

## Truth Table

INPUT		FUNCTION				OUTPUT
SC	SD	A1BUS	A2 BUS	B1 BUS	B2 BUS	
L	L	OUTPUT	OUTPUT	INPUT	INPUT	A1=B1,A2=B2
L	H	OUTPUT	INPUT	INPUT	OUTPUT*	A1=B1,B2=A2
H	L	INPUT	OUTPUT	OUTPUT*	INPUT	B1=A1,A2=B2
H	H	INPUT	INPUT	OUTPUT*	OUTPUT*	B1=A1,B2=A2

\* : High Impedance

## Operating Ranges

Characteristics	Symbol	Rating	Unit
Supply voltage	$V_{CC}$	1.65~5.5	V
		1.5~5.5 (Note 2)	
Input voltage	$V_{IN}$	0~5.5	V
Output voltage	$V_{OUT}$	0~5.5 (Note 3)	V
		0~ $V_{CC}$ (Note 4)	
Operating temperature	$T_{opr}$	-40~85	°C
Input rise and fall time	dt/dv	0~20 ( $V_{CC} = 1.8 V \pm 0.15 V$ , 2.5 V $\pm 0.2 V$ )	ns/V
		0~10 ( $V_{CC} = 3.3 V \pm 0.3 V$ )	
		0~5 ( $V_{CC} = 5.5 V \pm 0.5 V$ )	

Note 2 : Data retention only

Note 3 :  $V_{CC} = 0 V$

Note 4 : High or low state

## Electrical Characteristics

### DC Characteristics

Characteristics	Symbol	Test Condition	Ta = 25°C			Ta = -40~85°C		Unit			
			VCC (V)	Min	Typ.	Max	Min		Max		
High-Level Input Voltage	V <sub>IH</sub>	—	1.65~1.95	V <sub>CC</sub> × 0.75	—	—	V <sub>CC</sub> × 0.75	—	V		
			2.3~5.5	V <sub>CC</sub> × 0.7	—	—	V <sub>CC</sub> × 0.7	—			
Low-Level Input Voltage	V <sub>IL</sub>	—	1.65~1.95	—	—	V <sub>CC</sub> × 0.25	—	V <sub>CC</sub> × 0.25	V		
			2.3~5.5	—	—	V <sub>CC</sub> × 0.3	—	V <sub>CC</sub> × 0.3			
High-level output voltage	V <sub>OH</sub>	V <sub>IN</sub> = V <sub>IH</sub> or V <sub>IL</sub>	I <sub>OH</sub> = -100 μA	1.65	1.55	1.65	—	1.55	—	V	
				2.3	2.2	2.3	—	2.2	—		
				3.0	2.9	3.0	—	2.9	—		
				4.5	4.4	4.5	—	4.4	—		
			I <sub>OH</sub> = -4 mA	1.65	1.29	1.52	—	1.29	—		
				2.3	1.9	2.14	—	1.9	—		
				3.0	2.4	2.75	—	2.4	—		
				4.5	2.3	2.62	—	2.3	—		
I <sub>OH</sub> = -8 mA	3.0	2.3	2.62	—	2.3	—					
	4.5	3.8	4.13	—	3.8	—					
	I <sub>OH</sub> = -16 mA	3.0	2.3	2.62	—	2.3	—				
		4.5	3.8	4.13	—	3.8	—				
I <sub>OH</sub> = -24 mA		3.0	2.3	2.62	—	2.3	—				
		4.5	3.8	4.13	—	3.8	—				
	I <sub>OH</sub> = -32 mA	3.0	2.3	2.62	—	2.3	—				
		4.5	3.8	4.13	—	3.8	—				
Low-level output voltage		V <sub>OL</sub>	V <sub>IN</sub> = V <sub>IH</sub> or V <sub>IL</sub>	I <sub>OL</sub> = 100 μA	1.65	—	0	0.1	—	0.1	V
					2.3	—	0	0.1	—	0.1	
	3.0				—	0	0.1	—	0.1		
	4.5				—	0	0.1	—	0.1		
	I <sub>OL</sub> = 4 mA			1.65	—	0.08	0.24	—	0.24		
				2.3	—	0.1	0.3	—	0.3		
				3.0	—	0.16	0.4	—	0.4		
				4.5	—	0.24	0.55	—	0.55		
I <sub>OL</sub> = 8 mA	2.3	—	0.1	0.3	—	0.3					
	3.0	—	0.16	0.4	—	0.4					
	4.5	—	0.24	0.55	—	0.55					
	3.0	—	0.24	0.55	—	0.55					
I <sub>OL</sub> = 16 mA	3.0	—	0.24	0.55	—	0.55					
	4.5	—	0.25	0.55	—	0.55					
	I <sub>OL</sub> = 24 mA	3.0	—	0.24	0.55	—	0.55				
		4.5	—	0.25	0.55	—	0.55				
I <sub>OL</sub> = 32 mA		3.0	—	0.24	0.55	—	0.55				
		4.5	—	0.25	0.55	—	0.55				
	Input leakage current	I <sub>IN</sub>	V <sub>IN</sub> = 5.5 V or GND	0~5.5	—	—	±1	—	±10	μA	
	3-State Output Off-State Current	I <sub>OZ</sub>	V <sub>IN</sub> =V <sub>IH</sub> or V <sub>IL</sub> V <sub>OUT</sub> =V <sub>CC</sub> or GND	1.65~5.5	—	—	±5	—	±10	μA	
Power off leakage current	I <sub>OFF</sub>	V <sub>IN</sub> or V <sub>OUT</sub> = 5.5 V	0.0	—	—	1	—	10	μA		
Quiescent supply current	I <sub>CC</sub>	V <sub>IN</sub> = 5.5 V or GND	1.65~5.5	—	—	1	—	10	μA		

## AC Characteristics (input: $t_r = t_f = 3$ ns)

Characteristics	Symbol	Test Condition	Ta = 25°C			Ta = -40~85°C		Unit	
			V <sub>CC</sub> (V)	Min	Typ.	Max	Min		Max
Propagation delay time ( Buffer output)	$t_{pLH}$ $t_{pHL}$	$C_L = 15$ pF, $R_L = 1$ M $\Omega$	1.8 ± 0.15	2.0	—	17.0	2.0	18.5	ns
			2.5 ± 0.2	1.0	—	7.5	1.0	8.0	
			3.3 ± 0.3	0.8	—	5.2	1.2	6.0	
			5.0 ± 0.5	0.5	—	4.5	0.8	5.5	
		$C_L = 50$ pF, $R_L = 500$ $\Omega$	3.3 ± 0.3	1.5	—	6.7	1.5	7.0	
			5.0 ± 0.5	0.8	—	5.0	0.8	5.3	
Output to output skew	$t_{osLH}$ $t_{osHL}$	(Note 5)	3.3 ± 0.3	—	—	1.0	—	1.0	ns
3-state output Disable time ( Open drain output)	$t_{pLZ}$ $t_{pLZ}$	$C_L = 50$ pF, $R_L = 500$ $\Omega$	1.8 ± 0.15	1.8	—	9.5	1.8	10.5	ns
			2.5 ± 0.2	1.2	—	5.8	1.2	6.4	
			3.3 ± 0.3	0.8	—	5.0	0.8	5.3	
			5.0 ± 0.5	0.5	—	4.2	0.5	4.5	
Input capacitance	$C_{IN}$	—	0	—	7	—	—	—	pF
Bus input capacitance	$C_{I/O}$	—	5.5	—	8	—	—	—	pF
Output capacitance	$C_{OUT}$	—	5.5	—	9	—	—	—	pF
Power dissipation capacitance	$C_{PD}$	(Note 6)	3.3	—	29	—	—	—	pF
			5.5	—	33	—	—	—	
Minimum set-up time	$S_{ts}$	(Note 7)	2.5 ± 0.2	7.5	—	—	9.0	—	ns
			3.3 ± 0.3	7.0	—	—	8.2	—	
			5.0 ± 0.5	6.5	—	—	7.4	—	

Note 5 :Parameter guaranteed by design.  $t_{osLH} = |t_{pLHm} - t_{pLHn}|$ ,  $t_{osHL} = |t_{pHLm} - t_{pHLn}|$

Note 6 :  $C_{PD}$  is defined as the value of the internal equivalent capacitance which is calculated from the operating current consumption without load.

Average operating current can be obtained by the equation:

$$I_{CC} (opr.) = C_{PD} \cdot V_{CC} \cdot f_{IN} + I_{CC}/2$$

Note 7 :  $S_{ts}$  is the time which must be waited for an input signal when a bus signal direction is switched.

### AC Characteristics (input: $t_r = t_f = 3 \text{ ns}$ , Bn = Pull Up ( $R_{\text{Pull Up}} = 500 \Omega$ , $V_{\text{Pull Up}} = 5 \text{ V}$ ) )

Characteristics	Symbol	Test Condition	V <sub>CC</sub> (V)	Ta = 25°C			Ta = -40~85°C		Unit
				Min	Typ.	Max	Min	Max	
Propagation delay time ( An-Bn )	$t_{pZL}$ $t_{pLZ}$	Input = An = VIH or VIL  Output = Bn CL= 50 pF	$3.3 \pm 0.3$	1.0	—	9.0	1.0	11.0	ns
Propagation delay time ( Bn-An )	$t_{pLH}$ $t_{pHL}$	Input = Bn = 5 V or VIL  Output = An CL= 50 pF	$3.3 \pm 0.3$	1.0	—	6.5	1.0	7.0	ns
Output to output skew	$t_{oS LH}$ $t_{oS HL}$	(Note 8)	$3.3 \pm 0.3$	—	—	1.0	—	1.0	ns

Note 8 :Parameter guaranteed by design.  $t_{oS LH} = |t_{pLHm} - t_{pLHn}|$ ,  $t_{oS HL} = |t_{pHLm} - t_{pHLn}|$

### AC Characteristics (input: $t_r = t_f = 3 \text{ ns}$ , Bn = Pull Up ( $R_{\text{Pull Up}} = 10k \Omega$ , $V_{\text{Pull Up}} = 5 \text{ V}$ ) )

Characteristics	Symbol	Test Condition	V <sub>CC</sub> (V)	Ta = 25°C			Ta = -40~85°C		Unit
				Min	Typ.	Max	Min	Max	
Propagation delay time ( An-Bn )	$t_{pZL}$	Input = An = VIH or VIL	$3.3 \pm 0.3$	1.0	—	6.7	1.0	7.3	ns
	$t_{pLZ}$	Output = Bn CL= 50 pF		—	—	70.0	—	90.0	
Propagation delay time ( Bn-An )	$t_{pLH}$ $t_{pHL}$	Input = Bn = 5 V or VIL  Output = An CL= 50 pF	$3.3 \pm 0.3$	1.0	—	6.3	1.0	7.0	ns
Output to output skew	$t_{oS LH}$ $t_{oS HL}$	(Note 9)	$3.3 \pm 0.3$	—	—	1.0	—	1.0	ns

Note 9 :Parameter guaranteed by design.  $t_{oS LH} = |t_{pLHm} - t_{pLHn}|$ ,  $t_{oS HL} = |t_{pHLm} - t_{pHLn}|$

**Package Dimensions**

SSOP8-P-0.65

Unit : mm

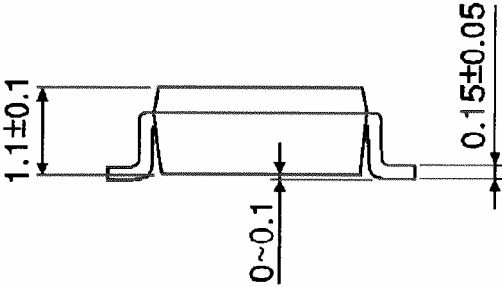
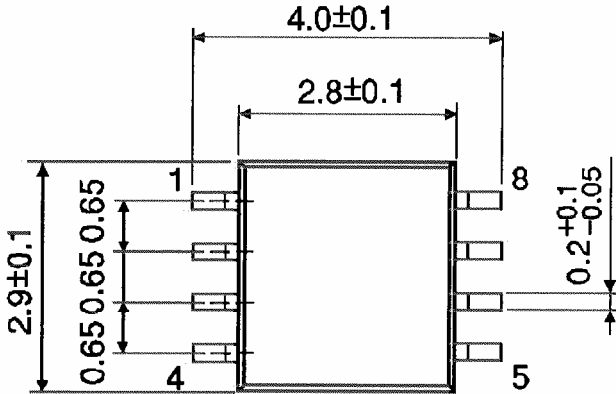

Weight: 0.02 g (typ.)

Package Dimensions

SSOP8-P-0.50A

Unit : mm

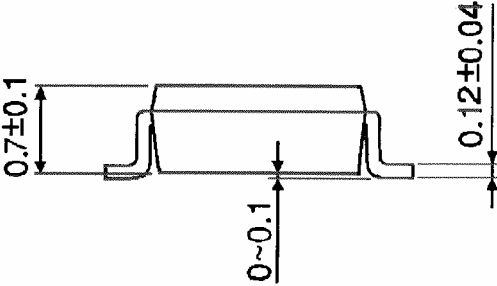
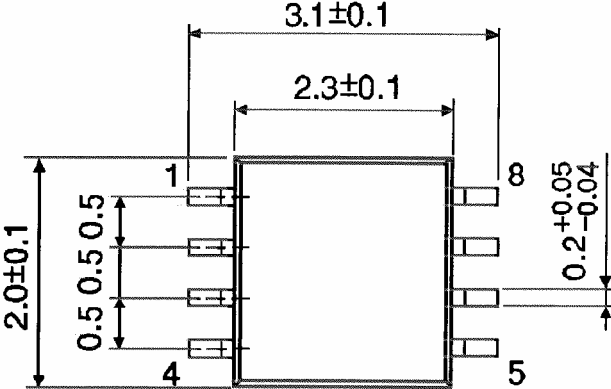

Weight: 0.01 g (typ.)

**RESTRICTIONS ON PRODUCT USE**

20070701-EN GENERAL

- The information contained herein is subject to change without notice.
- TOSHIBA is continually working to improve the quality and reliability of its products. Nevertheless, semiconductor devices in general can malfunction or fail due to their inherent electrical sensitivity and vulnerability to physical stress. It is the responsibility of the buyer, when utilizing TOSHIBA products, to comply with the standards of safety in making a safe design for the entire system, and to avoid situations in which a malfunction or failure of such TOSHIBA products could cause loss of human life, bodily injury or damage to property.  
In developing your designs, please ensure that TOSHIBA products are used within specified operating ranges as set forth in the most recent TOSHIBA products specifications. Also, please keep in mind the precautions and conditions set forth in the "Handling Guide for Semiconductor Devices," or "TOSHIBA Semiconductor Reliability Handbook" etc.
- The TOSHIBA products listed in this document are intended for usage in general electronics applications (computer, personal equipment, office equipment, measuring equipment, industrial robotics, domestic appliances, etc.). These TOSHIBA products are neither intended nor warranted for usage in equipment that requires extraordinarily high quality and/or reliability or a malfunction or failure of which may cause loss of human life or bodily injury ("Unintended Usage"). Unintended Usage include atomic energy control instruments, airplane or spaceship instruments, transportation instruments, traffic signal instruments, combustion control instruments, medical instruments, all types of safety devices, etc.. Unintended Usage of TOSHIBA products listed in this document shall be made at the customer's own risk.
- The products described in this document shall not be used or embedded to any downstream products of which manufacture, use and/or sale are prohibited under any applicable laws and regulations.
- The information contained herein is presented only as a guide for the applications of our products. No responsibility is assumed by TOSHIBA for any infringements of patents or other rights of the third parties which may result from its use. No license is granted by implication or otherwise under any patents or other rights of TOSHIBA or the third parties.
- Please contact your sales representative for product-by-product details in this document regarding RoHS compatibility. Please use these products in this document in compliance with all applicable laws and regulations that regulate the inclusion or use of controlled substances. Toshiba assumes no liability for damage or losses occurring as a result of noncompliance with applicable laws and regulations.