

### FEATURES

**Output frequency range:** 400 MHz to 6 GHz  
**1 dB output compression:**  $\geq 9.4$  dBm from 450 MHz to 4 GHz  
**Output return loss**  $\leq 14$  dB from 450 MHz to 5.5 GHz  
**Noise floor:**  $-160$  dBm/Hz @ 900 MHz  
**Sideband suppression:**  $< -50$  dBc @ 900 MHz  
**Carrier feedthrough:**  $< -46$  dBm @ 900 MHz  
**Baseband input bias level**  
     ADL5375-05: 500 mV  
     ADL5375-15: 1500 mV  
**Single supply:** 4.75 V to 5.25 V  
**24-lead LFCSP\_VQ package**

### APPLICATIONS

#### Cellular communication systems

GSM/EDGE, CDMA2000, W-CDMA, TD-SCDMA

#### WiMAX/broadband wireless access systems

#### Satellite modems

### GENERAL DESCRIPTION

The ADL5375 is a broadband quadrature modulator designed for operation from 400 MHz to 6 GHz. Its excellent phase accuracy and amplitude balance enable high performance intermediate frequency or direct radio frequency modulation for communication systems.

The ADL5375 features a broad baseband bandwidth, along with an output gain flatness that varies no more than 1 dB from 450 MHz to 3.8 GHz. These features, coupled with a broadband output return loss of  $\leq -14$  dB, make the ADL5375 ideally suited for broadband zero IF or low IF-to-RF applications,

### FUNCTIONAL BLOCK DIAGRAM

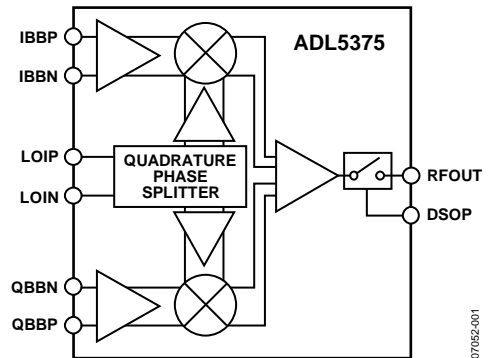

Figure 1.

broadband digital predistortion transmitters, and multiband radio designs.

The ADL5375 accepts two differential baseband inputs and a single-ended LO. It generates a single-ended 50  $\Omega$  output. The two versions offer input baseband bias levels of 500 mV (ADL5375-05) and 1500 mV (ADL5375-15).

The ADL5375 is fabricated using an advanced silicon-germanium bipolar process. It is available in a 24-lead, exposed paddle, Pb-free, LFCSP\_VQ package. Performance is specified over a  $-40^{\circ}\text{C}$  to  $+85^{\circ}\text{C}$  temperature range. A Pb-free evaluation board is also available.

#### Rev. 0

Information furnished by Analog Devices is believed to be accurate and reliable. However, no responsibility is assumed by Analog Devices for its use, nor for any infringements of patents or other rights of third parties that may result from its use. Specifications subject to change without notice. No license is granted by implication or otherwise under any patent or patent rights of Analog Devices. Trademarks and registered trademarks are the property of their respective owners.

**TABLE OF CONTENTS**

Features .....	1	RF Output.....	20
Applications.....	1	Output Disable.....	21
Functional Block Diagram .....	1	Optimization .....	22
General Description .....	1	Applications Information .....	23
Revision History .....	2	DAC Modulator Interfacing .....	23
Specifications.....	3	Using the AD9779 Auxiliary DAC for Carrier Feedthrough Nulling .....	24
Absolute Maximum Ratings.....	7	GSM/EDGE Operation .....	25
ESD Caution.....	7	W-CDMA Operation.....	25
Pin Configuration and Function Descriptions.....	8	LO Generation Using PLLs .....	26
Typical Performance Characteristics .....	9	Transmit DAC Options .....	26
ADL5375-05 .....	9	Modulator/Demodulator Options .....	26
ADL5375-15 .....	14	Evaluation Board .....	27
Theory of Operation .....	19	Thermal Grounding and Evaluation Board Layout.....	28
Circuit Description.....	19	Characterization Setup .....	29
Basic Connections .....	20	Outline Dimensions .....	31
Power Supply and Grounding.....	20	Ordering Guide .....	31
Baseband Inputs.....	20		
LO Input .....	20		

**REVISION HISTORY****12/07—Revision 0: Initial Version**

## SPECIFICATIONS

$V_S = 5\text{ V}$ ;  $T_A = 25^\circ\text{C}$ ; LO = 0 dBm single-ended drive; baseband I/Q amplitude = 1 V p-p differential sine waves in quadrature with a 500 mV (ADL5375-05) or 1500 mV (ADL5375-15) dc bias; baseband I/Q frequency ( $f_{BB}$ ) = 1 MHz, unless otherwise noted.

Table 1.

Parameter	Conditions	ADL5375-05			ADL5375-15			Unit
		Min	Typ	Max	Min	Typ	Max	
OPERATING FREQUENCY RANGE								
Low frequency			400		400			MHz
High frequency			6000		6000			MHz
LO = 450 MHz								
Output Power, $P_{OUT}$	$V_{IQ} = 1\text{ V p-p differential}$		0.87		0.46			dBm
Modulator Voltage Gain	RF output divided by baseband input voltage		-3.1		-3.5			dB
Output P1dB			9.4		9.9			dBm
Output Return Loss			-14.7		-14.7			dB
Carrier Feedthrough			-48.0		-52.2			dBm
Sideband Suppression			-33.1		-35.5			dBc
Quadrature Error			2.52		1.64			Degrees
I/Q Amplitude Balance			-0.05		-0.07			dB
Second Harmonic	$P_{OUT} - (f_{LO} + (2 \times f_{BB}))$		-74.5		-74.5			dBc
ADL5375-05	$P_{OUT} = 0.87\text{ dBm}$							
ADL5375-15	$P_{OUT} = 0.46\text{ dBm}$							
Third Harmonic	$P_{OUT} - (f_{LO} + (3 \times f_{BB}))$		-51.3		-77.1			dBc
ADL5375-05	$P_{OUT} = 0.87\text{ dBm}$							
ADL5375-15	$P_{OUT} = 0.46\text{ dBm}$							
Output IP2	$f_{1BB} = 3.5\text{ MHz}$ , $f_{2BB} = 4.5\text{ MHz}$ , $P_{OUT} \approx -5\text{ dBm @ } f_{LO} = 900\text{ MHz}$		65.0		67.9			dBm
Output IP3	$f_{1BB} = 3.5\text{ MHz}$ , $f_{2BB} = 4.5\text{ MHz}$ , $P_{OUT} \approx -5\text{ dBm @ } f_{LO} = 900\text{ MHz}$		28.1		23.0			dBm
Noise Floor	I/Q inputs = 0 V differential with a dc bias only, 20 MHz carrier offset		-160.5		-157.0			dBm/Hz
LO = 900 MHz								
Output Power, $P_{OUT}$	$V_{IQ} = 1\text{ V p-p differential}$		0.87		0.47			dBm
Modulator Voltage Gain	RF output divided by baseband input voltage		-3.1		-3.5			dB
Output P1dB			9.4		9.9			dBm
Output Return Loss			-14.1		-14.1			dB
Carrier Feedthrough			-46.2		-46.2			dBm
Sideband Suppression			-52.1		-50.4			dBc
Quadrature Error			-0.29		-0.37			Degrees
I/Q Amplitude Balance			-0.05		-0.07			dB
Second Harmonic	$P_{OUT} - (f_{LO} + (2 \times f_{BB}))$		-73.3		-73			dBc
ADL5375-05	$P_{OUT} = 0.87\text{ dBm}$							
ADL5375-15	$P_{OUT} = 0.47\text{ dBm}$							
Third Harmonic	$P_{OUT} - (f_{LO} + (3 \times f_{BB}))$		-51.5		-71			dBc
ADL5375-05	$P_{OUT} = 0.87\text{ dBm}$							
ADL5375-15	$P_{OUT} = 0.47\text{ dBm}$							
Output IP2	$f_{1BB} = 3.5\text{ MHz}$ , $f_{2BB} = 4.5\text{ MHz}$ , $P_{OUT} \approx -5\text{ dBm @ } f_{LO} = 900\text{ MHz}$		68.3		66.2			dBm
Output IP3	$f_{1BB} = 3.5\text{ MHz}$ , $f_{2BB} = 4.5\text{ MHz}$ , $P_{OUT} \approx -5\text{ dBm @ } f_{LO} = 900\text{ MHz}$		26.8		22.9			dBm
Noise Floor	I/Q inputs = 0 V differential with a dc bias only, 20 MHz carrier offset		-160.0		-157.1			dBm/Hz

# ADL5375

Parameter	Conditions	ADL5375-05			ADL5375-15			Unit
		Min	Typ	Max	Min	Typ	Max	
LO = 1900 MHz								
Output Power, P <sub>OUT</sub>	V <sub>IQ</sub> = 1 V p-p differential		1.01		0.63			dBm
Modulator Voltage Gain	RF output divided by baseband input voltage		-3.0		-3.4			dB
Output P1dB			9.8		10.4			dBm
Output Return Loss			-14.1		-13.6			dB
Carrier Feedthrough			-40.5		-39.0			dBm
Sideband Suppression			-54.2		-51.3			dBc
Quadrature Error			-0.24		-0.15			Degrees
I/Q Amplitude Balance			-0.05		-0.08			dB
Second Harmonic	P <sub>OUT</sub> - (f <sub>LO</sub> + (2 × f <sub>BB</sub> ))		-67		-73			dBc
ADL5375-05	P <sub>OUT</sub> = 1.01 dBm							
ADL5375-15	P <sub>OUT</sub> = 0.63 dBm							
Third Harmonic	P <sub>OUT</sub> - (f <sub>LO</sub> + (3 × f <sub>BB</sub> ))		-52		-62			dBc
ADL5375-05	P <sub>OUT</sub> = 1.01 dBm							
ADL5375-15	P <sub>OUT</sub> = 0.63 dBm							
Output IP2	f <sub>1BB</sub> = 3.5 MHz, f <sub>2BB</sub> = 4.5 MHz, P <sub>OUT</sub> ≈ -5 dBm @ f <sub>LO</sub> = 900 MHz		62.7		63.8			dBm
Output IP3	f <sub>1BB</sub> = 3.5 MHz, f <sub>2BB</sub> = 4.5 MHz, P <sub>OUT</sub> ≈ -5 dBm @ f <sub>LO</sub> = 900 MHz		24.6		22.1			dBm
Noise Floor	I/Q inputs = 0 V differential with a dc bias only, 20 MHz carrier offset		-160.0		-158.2			dBm/Hz
LO = 2150 MHz								
Output Power, P <sub>OUT</sub>	V <sub>IQ</sub> = 1 V p-p differential		1.05		0.67			dBm
Modulator Voltage Gain	RF output divided by baseband input voltage		-2.9		-3.3			dB
Output P1dB			10.0		10.4			dBm
Output Return Loss			-14.2		-13.9			dB
Carrier Feedthrough			-40.6		-37.9			dBm
Sideband Suppression			-45.0		-44.7			dBc
Quadrature Error			-0.72		-0.58			Degrees
I/Q Amplitude Balance			-0.04		-0.06			dB
Second Harmonic	P <sub>OUT</sub> - (f <sub>LO</sub> + (2 × f <sub>BB</sub> ))		-68		-62			dBc
ADL5375-05	P <sub>OUT</sub> = 1.05 dBm							
ADL5375-15	P <sub>OUT</sub> = 0.67 dBm							
Third Harmonic	P <sub>OUT</sub> - (f <sub>LO</sub> + (3 × f <sub>BB</sub> ))		-53		-63			dBc
ADL5375-05	P <sub>OUT</sub> = 1.05 dBm							
ADL5375-15	P <sub>OUT</sub> = 0.67 dBm							
Output IP2	f <sub>1BB</sub> = 3.5 MHz, f <sub>2BB</sub> = 4.5 MHz, P <sub>OUT</sub> ≈ -5 dBm @ f <sub>LO</sub> = 900 MHz		58.7		55.8			dBm
Output IP3	f <sub>1BB</sub> = 3.5 MHz, f <sub>2BB</sub> = 4.5 MHz, P <sub>OUT</sub> ≈ -5 dBm @ f <sub>LO</sub> = 900 MHz		25.7		22.1			dBm
Noise Floor	I/Q inputs = 0 V differential with a dc bias only, 20 MHz carrier offset		-159.5		-157.9			dBm/Hz

Parameter	Conditions	ADL5375-05			ADL5375-15			Unit
		Min	Typ	Max	Min	Typ	Max	
LO = 2600 MHz								
Output Power, P <sub>OUT</sub>	V <sub>IQ</sub> = 1 V p-p differential		1.18		0.78			dBm
Modulator Voltage Gain	RF output divided by baseband input voltage		-2.8		-3.2			dB
Output P1dB			10.3		10.6			dBm
Output Return Loss			-15.1		-14.5			dB
Carrier Feedthrough			-41.0		-42.3			dBm
Sideband Suppression			-44.3		-45.6			dBc
Quadrature Error			-0.72		-0.60			Degrees
I/Q Amplitude Balance			-0.04		-0.07			dB
Second Harmonic	P <sub>OUT</sub> - (f <sub>LO</sub> + (2 × f <sub>BB</sub> ))		-57		-55			dBc
ADL5375-05	P <sub>OUT</sub> = 1.18 dBm							
ADL5375-15	P <sub>OUT</sub> = 0.78 dBm							
Third Harmonic	P <sub>OUT</sub> - (f <sub>LO</sub> + (3 × f <sub>BB</sub> ))		-52		-52			dBc
ADL5375-05	P <sub>OUT</sub> = 1.18 dBm							
ADL5375-15	P <sub>OUT</sub> = 0.78 dBm							
Output IP2	f <sub>1BB</sub> = 3.5 MHz, f <sub>2BB</sub> = 4.5 MHz, P <sub>OUT</sub> ≈ -5 dBm @ f <sub>LO</sub> = 900 MHz		49.0		48.5			dBm
Output IP3	f <sub>1BB</sub> = 3.5 MHz, f <sub>2BB</sub> = 4.5 MHz, P <sub>OUT</sub> ≈ -5 dBm @ f <sub>LO</sub> = 900 MHz		21.8		19.4			dBm
Noise Floor	I/Q inputs = 0 V differential with a dc bias only, 20 MHz carrier offset		-159.0		-157.6			dBm/Hz
LO = 3500 MHz								
Output Power, P <sub>OUT</sub>	V <sub>IQ</sub> = 1 V p-p differential		1.71		1.14			dBm
Modulator Voltage Gain	RF output divided by baseband input voltage		-2.3		-2.8			dB
Output P1dB			10.4		10.1			dBm
Output Return Loss			-21.6		-20.4			dB
Carrier Feedthrough			-30.5		-29.0			dBm
Sideband Suppression			-49.3		-44.9			dBc
Quadrature Error			-0.20		-0.54			Degrees
I/Q Amplitude Balance			-0.07		-0.08			dB
Second Harmonic	P <sub>OUT</sub> - (f <sub>LO</sub> + (2 × f <sub>BB</sub> ))		-54		-61			dBc
ADL5375-05	P <sub>OUT</sub> = 1.71 dBm							
ADL5375-15	P <sub>OUT</sub> = 1.14 dBm							
Third Harmonic	P <sub>OUT</sub> - (f <sub>LO</sub> + (3 × f <sub>BB</sub> ))		-53		-51			dBc
ADL5375-05	P <sub>OUT</sub> = 1.71 dBm							
ADL5375-15	P <sub>OUT</sub> = 1.14 dBm							
Output IP2	f <sub>1BB</sub> = 3.5 MHz, f <sub>2BB</sub> = 4.5 MHz, P <sub>OUT</sub> ≈ -5 dBm @ f <sub>LO</sub> = 900 MHz		50.0		57.9			dBm
Output IP3	f <sub>1BB</sub> = 3.5 MHz, f <sub>2BB</sub> = 4.5 MHz, P <sub>OUT</sub> ≈ -5 dBm @ f <sub>LO</sub> = 900 MHz		23.8		19.5			dBm
Noise Floor	I/Q inputs = 0 V differential with a dc bias only, 20 MHz carrier offset		-157.6		-156.3			dBm/Hz

# ADL5375

Parameter	Conditions	ADL5375-05			ADL5375-15			Unit
		Min	Typ	Max	Min	Typ	Max	
LO = 5800 MHz								
Output Power, P <sub>OUT</sub>	V <sub>IQ</sub> = 1 V p-p differential		2.40			0.82		dBm
Modulator Voltage Gain	RF output divided by baseband input voltage		-1.6			-3.2		dB
Output P1dB			5.7			6.6		dBm
Output Return Loss			-11.4			-10.5		dB
Carrier Feedthrough			-23.0			-16.3		dBm
Sideband Suppression			-36.0			-33.0		dBc
Quadrature Error			-1.42			+1.17		Degrees
I/Q Amplitude Balance			0.20			0.50		dB
Second Harmonic	P <sub>OUT</sub> – (f <sub>LO</sub> + (2 × f <sub>BB</sub> ))		-57			-58		dBc
ADL5375-05	P <sub>OUT</sub> = 2.40 dBm							
ADL5375-15	P <sub>OUT</sub> = 0.82 dBm							
Third Harmonic	P <sub>OUT</sub> – (f <sub>LO</sub> + (3 × f <sub>BB</sub> ))		-43			-52		dBc
ADL5375-05	P <sub>OUT</sub> = 2.40 dBm							
ADL5375-15	P <sub>OUT</sub> = 0.82 dBm							
Output IP2	f <sub>1BB</sub> = 3.5 MHz, f <sub>2BB</sub> = 4.5 MHz, P <sub>OUT</sub> ≈ -5 dBm @ f <sub>LO</sub> = 900 MHz		38.7			35.7		dBm
Output IP3	f <sub>1BB</sub> = 3.5 MHz, f <sub>2BB</sub> = 4.5 MHz, P <sub>OUT</sub> ≈ -5 dBm @ f <sub>LO</sub> = 900 MHz		13.5			12.1		dBm
Noise Floor	I/Q inputs = 0 V differential with a dc bias only, 20 MHz carrier offset		-153.0			-153.4		dBm/Hz
LO INPUTS								
LO Drive Level	Characterization performed at typical level	-6	0	+7	-6	0	+7	dBm
Input Return Loss	500 MHz < f <sub>LO</sub> < 3.3 GHz See Figure 7 and Figure 32 for return loss vs. frequency		≤ -10			≤ -10		dB
BASEBAND INPUTS	Pin IBBP, Pin IBBN, Pin QBBP, Pin QBBN							
I/Q Input Bias Level			500			1500		mV
Input Bias Current	Current sourcing from each baseband input		41			32		μA
Input Offset Current			0.1			0.1		μA
Differential Input Impedance			60			100		kΩ
Bandwidth (0.1 dB)	LO = 1900 MHz, baseband input = 500 mV p-p sine wave		95			80		MHz
OUTPUT DISABLE	Pin DSOP							
Off Isolation	P <sub>OUT</sub> (DSOP high) – P <sub>OUT</sub> (DSOP low) DSOP low, LO leakage, LO = 2150 MHz		86			85		dB
Turn-On Settling Time	DSOP high to low (90% of envelope)		-53			-53		dBm
Turn-Off Settling Time	DSOP low to high (10% of envelope)		200			200		ns
DSOP High Level (Logic 1)			100			100		ns
DSOP Low Level (Logic 0)		2.0			2.0			V
				0.8			0.8	V
POWER SUPPLIES	Pin VPS1 and Pin VPS2							
Voltage		4.75		5.25	4.75		5.25	V
Supply Current	DSOP = high		200			200		mA
	DSOP = low		131			131		mA

## ABSOLUTE MAXIMUM RATINGS

Table 2.

Parameter	Rating
Supply Voltage, VPOS	5.5 V
IBBP, IBBN, QBBP, QBBN	0 V to 2 V
LOIP and LOIN	13 dBm
Internal Power Dissipation	
ADL5375-05	1500 mW
ADL5375-15	1200 mW
$\theta_{JA}$ (Exposed Paddle Soldered Down) <sup>1</sup>	54°C/W
Maximum Junction Temperature	150°C
Operating Temperature Range	-40°C to +85°C
Storage Temperature Range	-65°C to +150°C

<sup>1</sup> Per JEDEC standard JESD 51-2. For information on optimizing thermal impedance, see the Thermal Grounding and Evaluation Board Layout section.

Stresses above those listed under Absolute Maximum Ratings may cause permanent damage to the device. This is a stress rating only; functional operation of the device at these or any other conditions above those indicated in the operational section of this specification is not implied. Exposure to absolute maximum rating conditions for extended periods may affect device reliability.

### ESD CAUTION



**ESD (electrostatic discharge) sensitive device.** Charged devices and circuit boards can discharge without detection. Although this product features patented or proprietary protection circuitry, damage may occur on devices subjected to high energy ESD. Therefore, proper ESD precautions should be taken to avoid performance degradation or loss of functionality.

## PIN CONFIGURATION AND FUNCTION DESCRIPTIONS

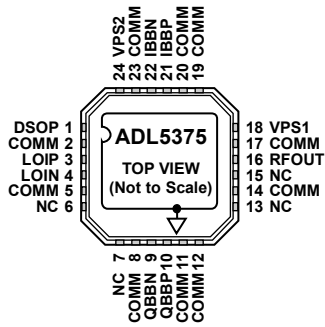

Figure 2. Pin Configuration

Table 3. Pin Function Descriptions

Pin No.	Mnemonic	Description
1	DSOP	Output Disable. A logic high on this pin disables the RF output. Connect this pin to ground or leave it floating to enable the output.
2, 5, 8, 11, 12, 14, 17, 19, 20, 23	COMM	Input Common Pins. Connect to the ground plane via a low impedance path.
3, 4	LOIP, LOIN	Local Oscillator Inputs. Single-ended operation: The LOIP pin is driven from the LO source through an ac-coupling capacitor while the LOIN pin is ac-coupled to ground through a capacitor. Differential operation: The LOIP and LOIN pins must be driven differentially through ac-coupling capacitors in this mode of operation.
6, 7, 13, 15, 9, 10, 21, 22	NC QBBN, QBBP, IBBP, IBBN	No Connect. These pins can be left open or tied to ground. Differential In-Phase and Quadrature Baseband Inputs. These high impedance inputs should be dc-biased to the recommended level depending on the version. ADL5375-05: 500 mV ADL5375-15: 1500 mV These inputs should be driven from a low impedance source. Nominal characterized ac signal swing is 500 mV p-p on each pin. This results in a differential drive of 1 V p-p. These inputs are not self-biased and have to be externally biased.
16	RFOUT	RF Output. Single-ended, 50 $\Omega$ internally biased RF output. RFOUT must be ac-coupled to the load.
18, 24	VPS1, VPS2	Positive Supply Voltage Pins. All pins should be connected to the same supply ( $V_S$ ). To ensure adequate external bypassing, connect 0.1 $\mu$ F and 1000 pF capacitors between each pin and ground.
	EP	Exposed Paddle. Connect to the ground plan via a low impedance path.



# TYPICAL PERFORMANCE CHARACTERISTICS

## ADL5375-05

$V_S = 5\text{ V}$ ;  $T_A = 25^\circ\text{C}$ ; LO = 0 dBm single-ended drive; baseband I/Q amplitude = 1 V p-p differential sine waves in quadrature with a 500 mV dc bias; baseband I/Q frequency ( $f_{\text{BB}}$ ) = 1 MHz, unless otherwise noted.

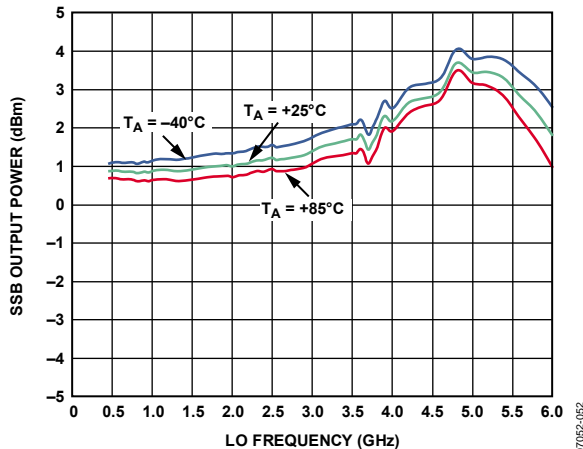

Figure 3. Single-Sideband (SSB) Output Power ( $P_{\text{OUT}}$ ) vs. LO Frequency ( $f_{\text{LO}}$ ) and Temperature

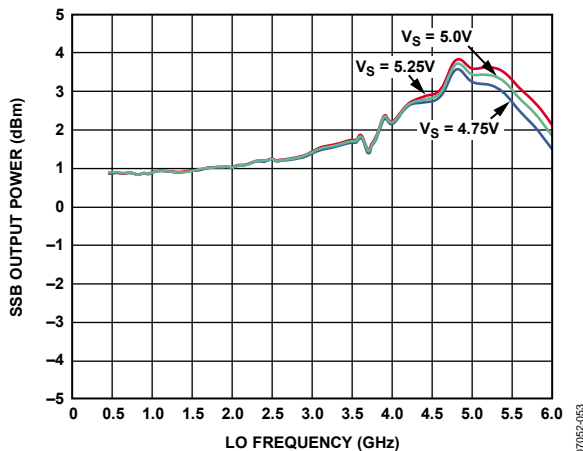

Figure 4. Single-Sideband (SSB) Output Power ( $P_{\text{OUT}}$ ) vs. LO Frequency ( $f_{\text{LO}}$ ) and Supply

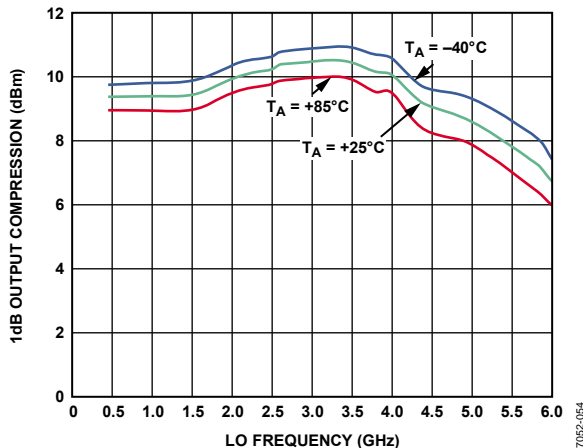

Figure 5. SSB Output 1dB Compression Point (OP1dB) vs. LO Frequency ( $f_{\text{LO}}$ ) and Temperature

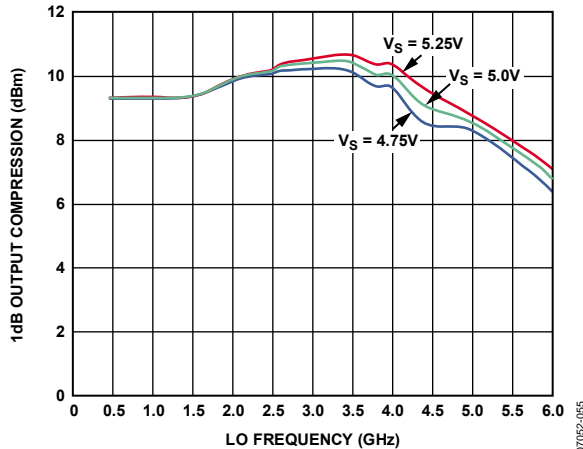

Figure 6. SSB Output 1dB Compression Point (OP1dB) vs. LO Frequency ( $f_{\text{LO}}$ ) and Supply

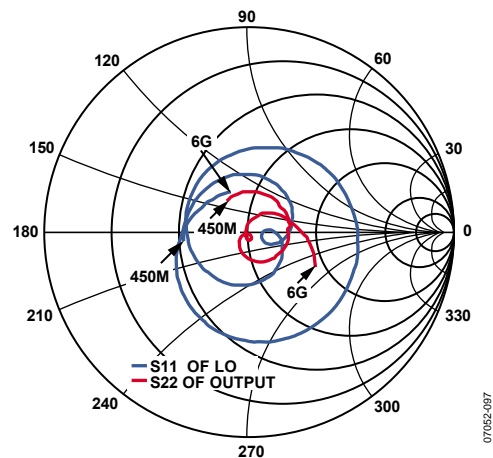

Figure 7. Smith Chart of LOIP (LOIN AC-Coupled to Ground) S11 and RFOUT S22 from 450 MHz to 6000 MHz

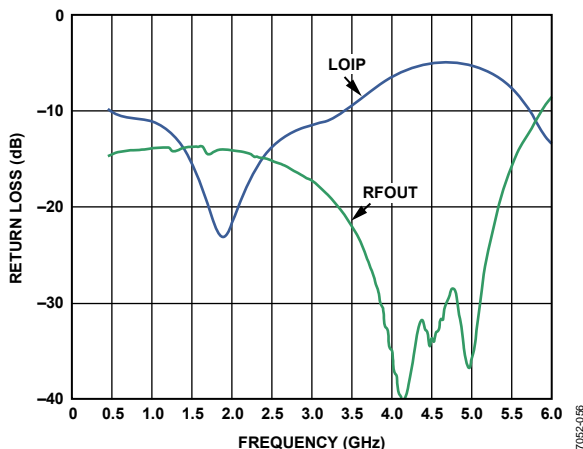

Figure 8. Return Loss of LOIP (LOIN AC-Coupled to Ground) S11 and RFOUT S22 from 450 MHz to 6000 MHz

## ADL5375-05

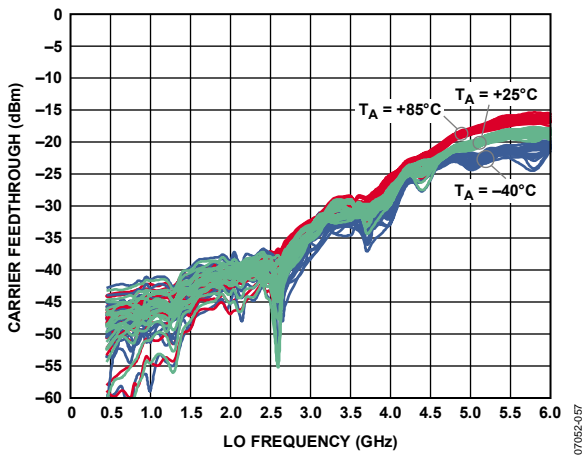

Figure 9. Carrier Feedthrough vs. LO Frequency ( $f_{LO}$ ) and Temperature; Multiple Devices Shown

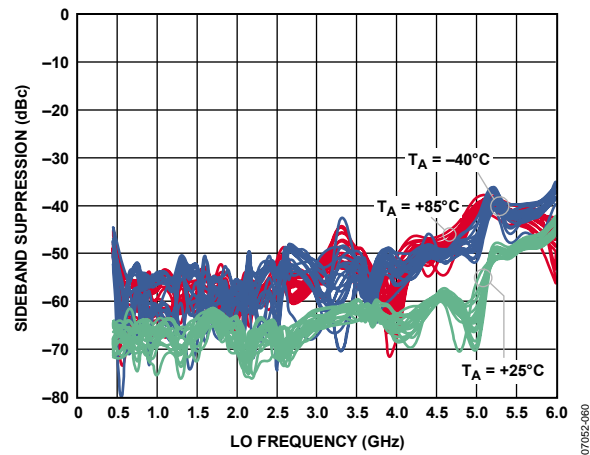

Figure 12. Sideband Suppression vs. LO Frequency ( $f_{LO}$ ) and Temperature After Nulling at 25°C; Multiple Devices Shown

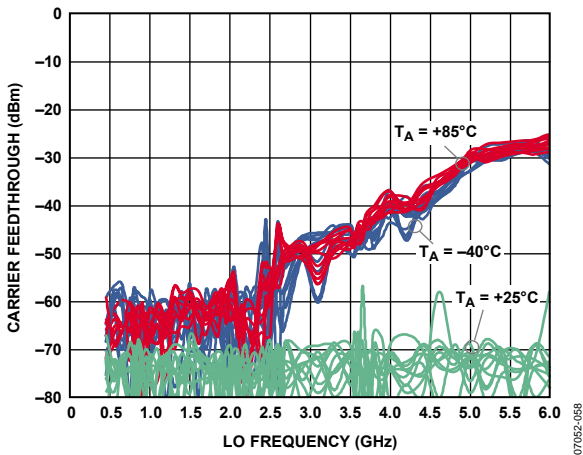

Figure 10. Carrier Feedthrough vs. LO Frequency ( $f_{LO}$ ) and Temperature After Nulling at 25°C; Multiple Devices Shown

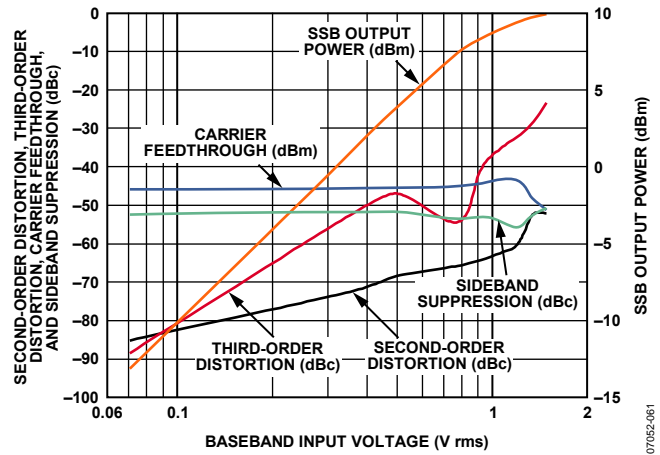

Figure 13. Second- and Third-Order Distortion, Carrier Feedthrough, Sideband Suppression, and SSB  $P_{OUT}$  vs. Baseband Differential Input Level ( $f_{LO} = 900$  MHz)

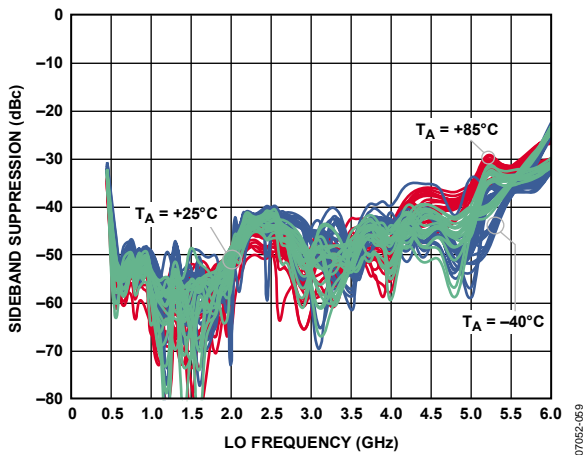

Figure 11. Sideband Suppression vs. LO Frequency ( $f_{LO}$ ) and Temperature; Multiple Devices Shown

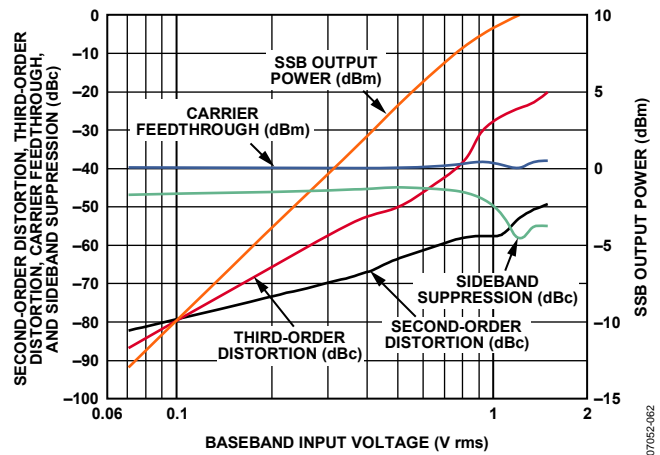

Figure 14. Second- and Third-Order Distortion, Carrier Feedthrough, Sideband Suppression, and SSB  $P_{OUT}$  vs. Baseband Differential Input Level ( $f_{LO} = 2150$  MHz)

ADL5375-05

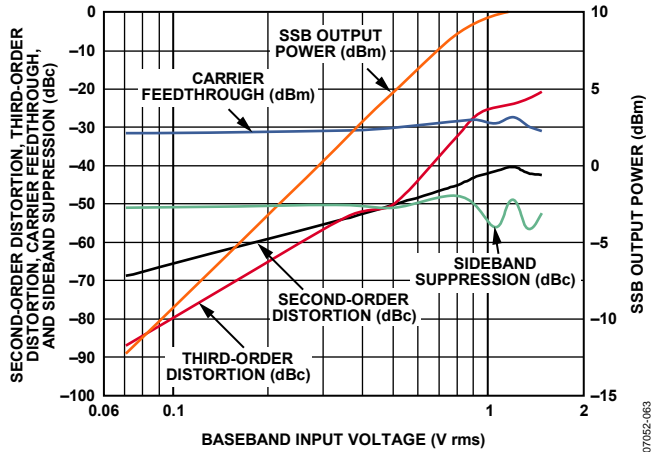

Figure 15. Second- and Third-Order Distortion, Carrier Feedthrough, Sideband Suppression, and SSB  $P_{OUT}$  vs. Baseband Differential Input Level ( $f_{LO} = 3500$  MHz)

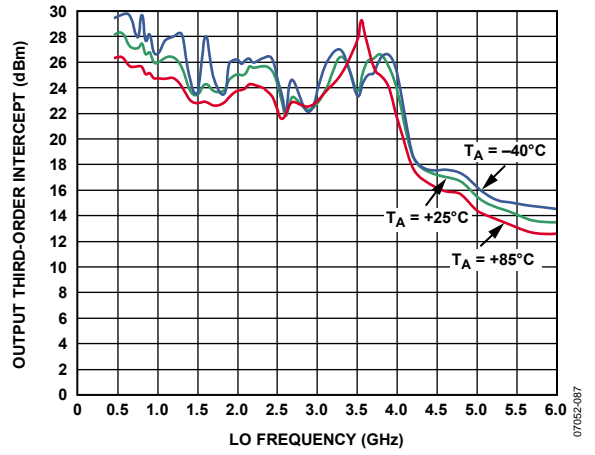

Figure 18. OIP3 vs. LO Frequency ( $f_{LO}$ ) and Temperature ( $P_{OUT} \approx -5$  dBm @  $f_{LO} = 900$  MHz)

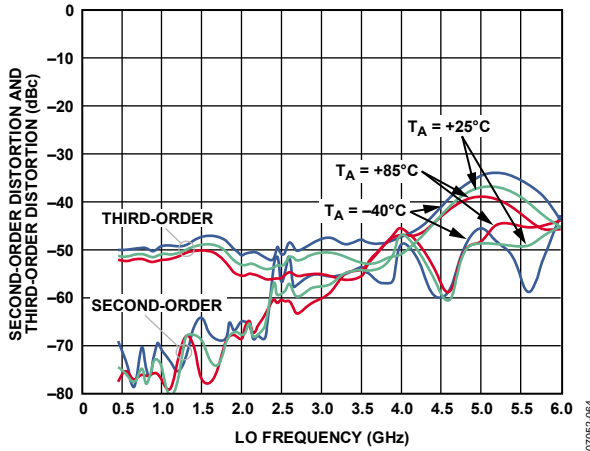

Figure 16. Second- and Third-Order Distortion vs. LO Frequency ( $f_{LO}$ ) and Temperature (Baseband I/Q Amplitude = 1 V p-p Differential)

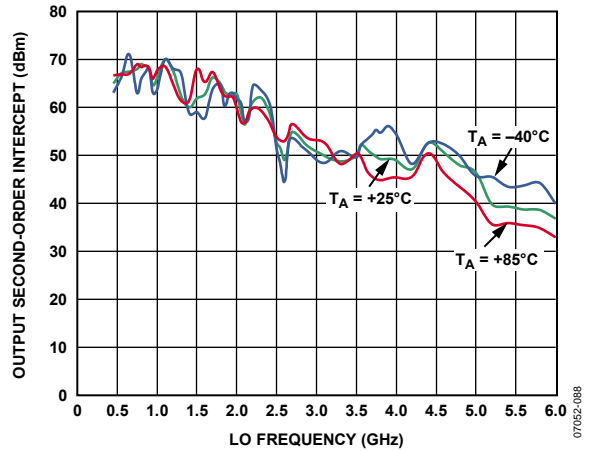

Figure 19. OIP2 vs. LO Frequency ( $f_{LO}$ ) and Temperature ( $P_{OUT} \approx -5$  dBm @  $f_{LO} = 900$  MHz)

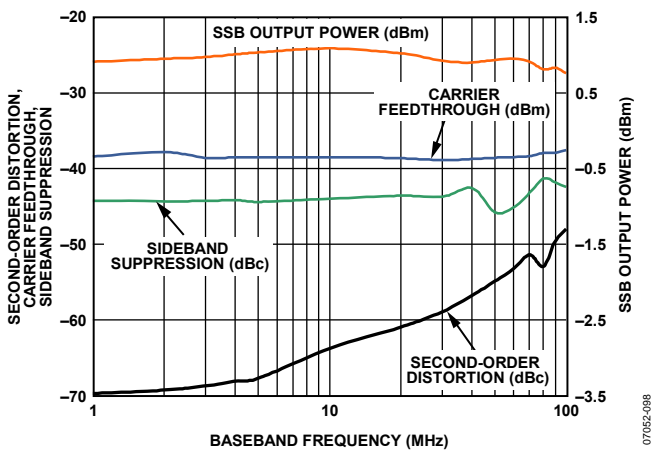

Figure 17. Second-Order Distortion, Carrier Feedthrough, Sideband Suppression, and SSB  $P_{OUT}$  vs. Baseband Frequency ( $f_{BB}$ );  $f_{LO} = 2140$  MHz

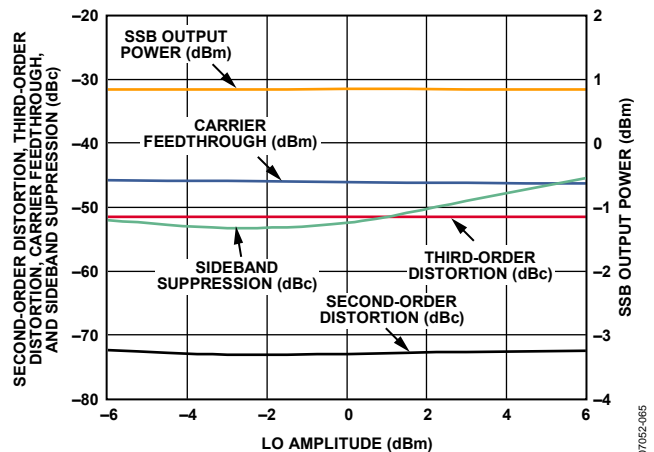

Figure 20. Second- and Third-Order Distortion, Carrier Feedthrough, Sideband Suppression, and SSB  $P_{OUT}$  vs. LO Amplitude ( $f_{LO} = 900$  MHz)

## ADL5375-05

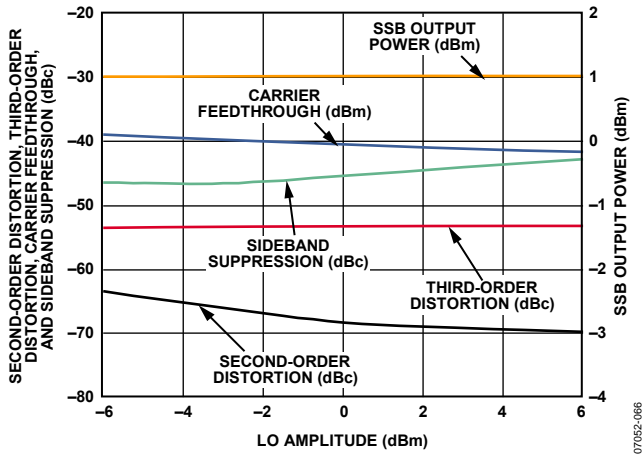

Figure 21. Second- and Third-Order Distortion, Carrier Feedthrough, Sideband Suppression, and SSB  $P_{OUT}$  vs. LO Amplitude ( $f_{LO} = 2150$  MHz)

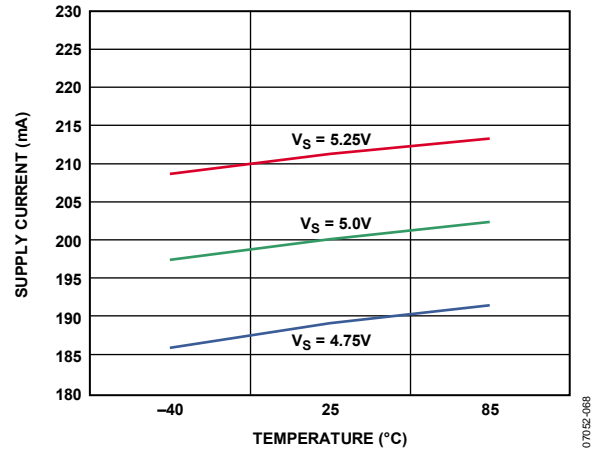

Figure 23. Power Supply Current vs. Temperature

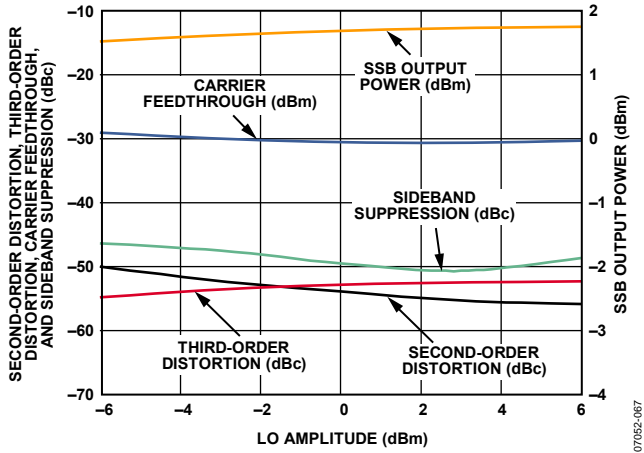

Figure 22. Second- and Third-Order Distortion, Carrier Feedthrough, Sideband Suppression, and SSB  $P_{OUT}$  vs. LO Amplitude ( $f_{LO} = 3500$  MHz)

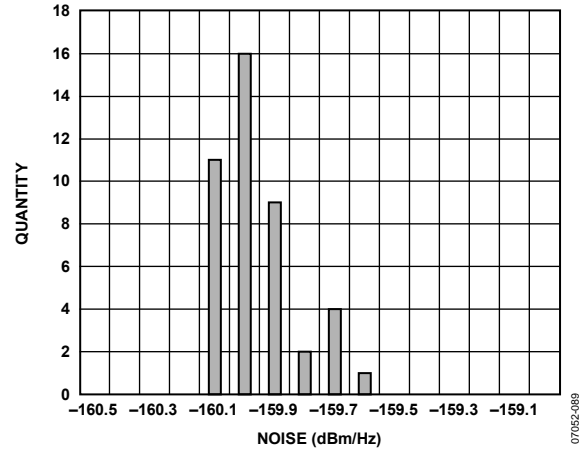

Figure 24. 20 MHz Offset Noise Floor Distribution at  $f_{LO} = 900$  MHz (I/Q Amplitude = 0 mV p-p with 500 mV DC Bias)

ADL5375-05

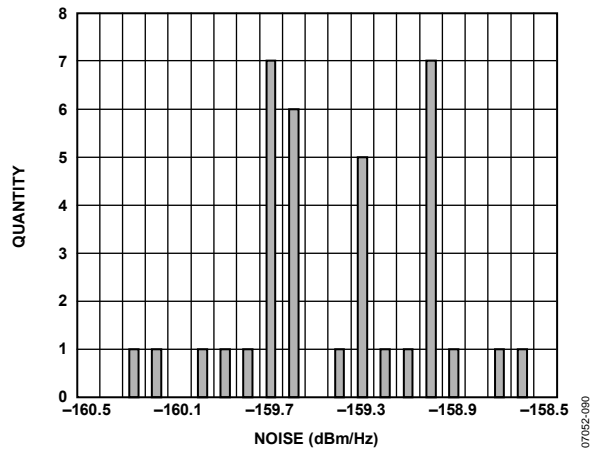

Figure 25. 20 MHz Offset Noise Floor Distribution at  $f_{LO} = 2140$  MHz (I/Q Amplitude = 0 mV p-p with 500 mV DC Bias)

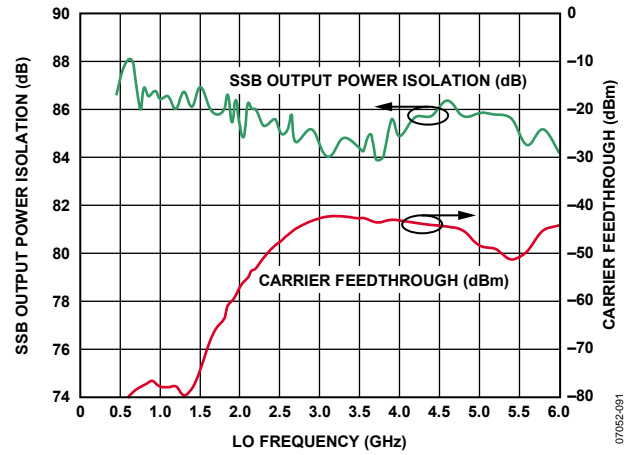

Figure 27. SSB  $P_{OUT}$  Isolation and Carrier Feedthrough with DSOP High

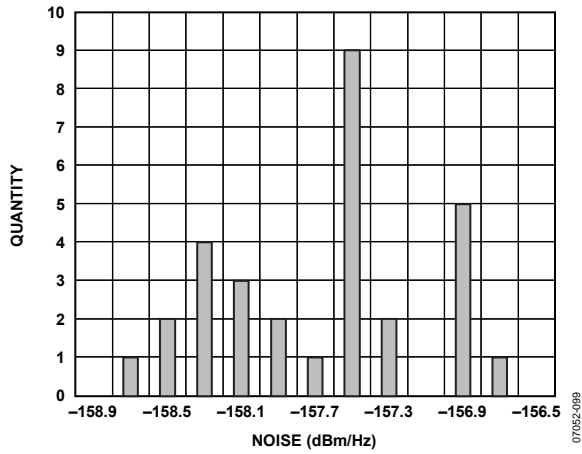

Figure 26. 20 MHz Offset Noise Floor Distribution at  $f_{LO} = 3500$  MHz (I/Q Amplitude = 0 mV p-p with 500 mV DC Bias)

# ADL5375

## ADL5375-15

$V_S = 5\text{ V}$ ;  $T_A = 25^\circ\text{C}$ ; LO = 0 dBm single-ended drive; baseband I/Q amplitude = 1 V p-p differential sine waves in quadrature with a 1500 mV dc bias; baseband I/Q frequency ( $f_{BB}$ ) = 1 MHz, unless otherwise noted.

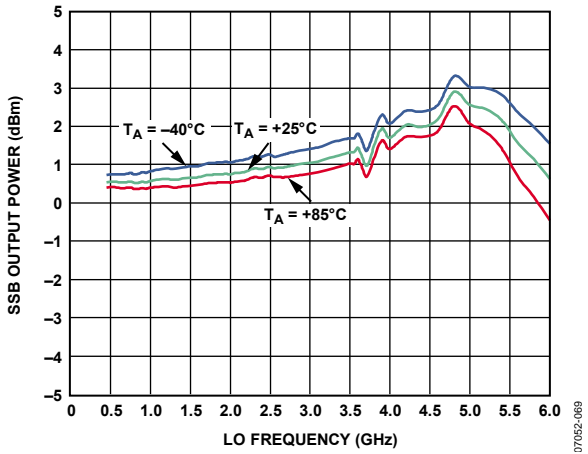

Figure 28. Single-Sideband (SSB) Output Power ( $P_{OUT}$ ) vs. LO Frequency ( $f_{LO}$ ) and Temperature

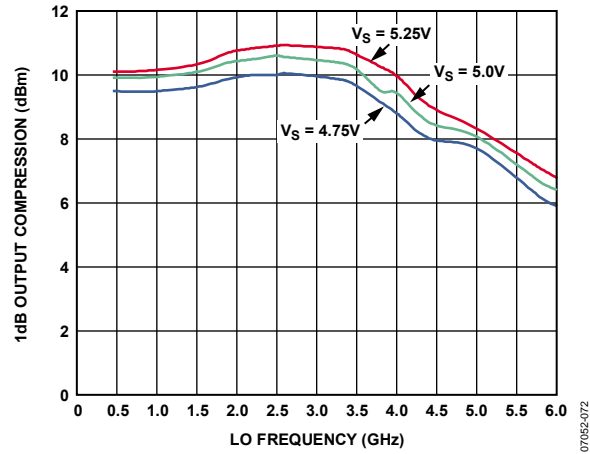

Figure 31. SSB Output 1dB Compression Point ( $OP_{1dB}$ ) vs. LO Frequency ( $f_{LO}$ ) and Supply

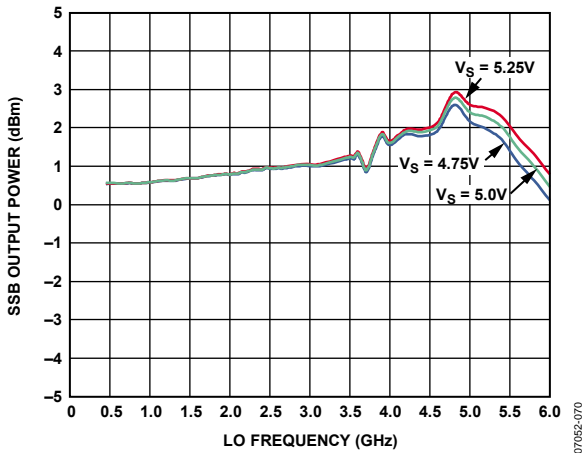

Figure 29. Single-Sideband (SSB) Output Power ( $P_{OUT}$ ) vs. LO Frequency ( $f_{LO}$ ) and Supply

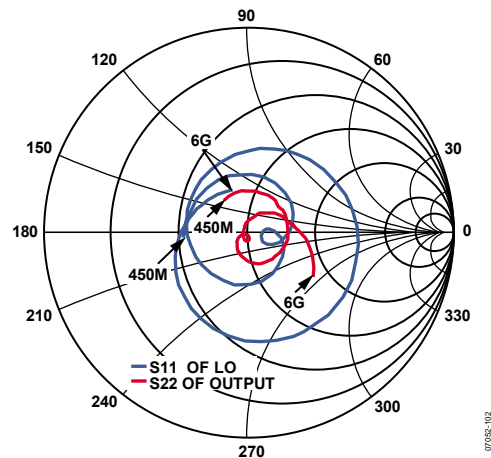

Figure 32. Smith Chart of LOIP (LOIN AC-Coupled to Ground)  $S_{11}$  and RFOUT  $S_{22}$  from 450 MHz to 6000 MHz

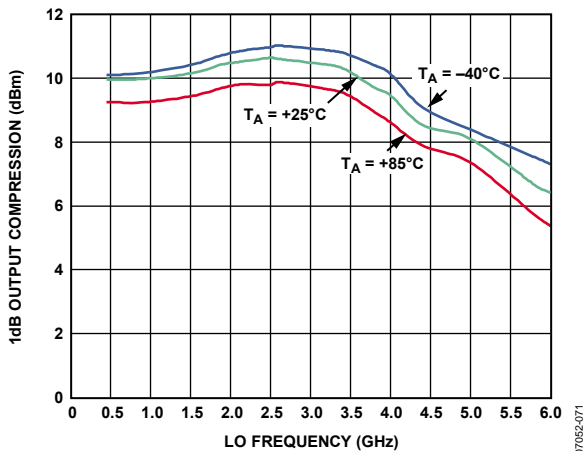

Figure 30. SSB Output 1dB Compression Point ( $OP_{1dB}$ ) vs. LO Frequency ( $f_{LO}$ ) and Temperature

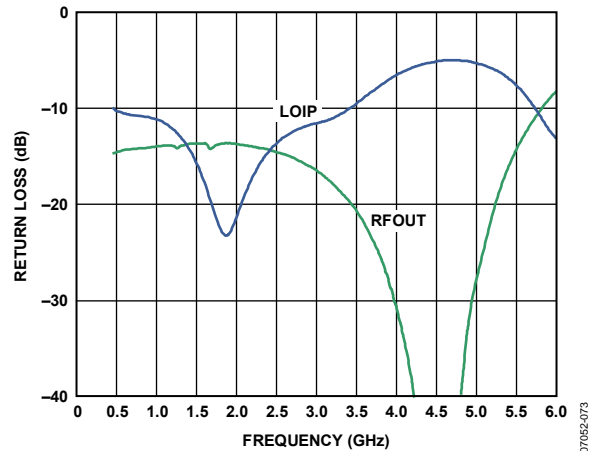

Figure 33. Return Loss of LOIP (LOIN AC-Coupled to Ground)  $S_{11}$  and RFOUT  $S_{22}$  from 450 MHz to 6000 MHz

ADL5375-15

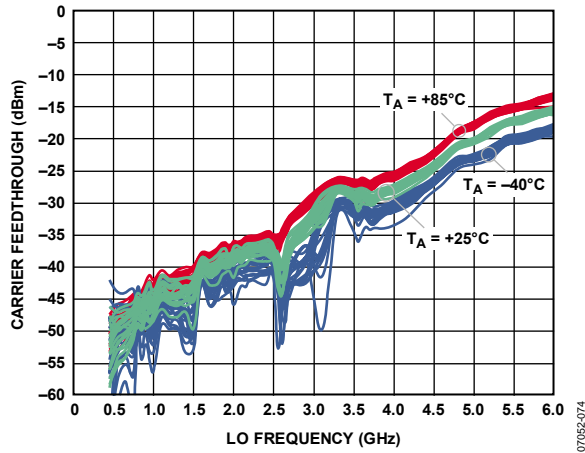

Figure 34. Carrier Feedthrough vs. LO Frequency ( $f_{LO}$ ) and Temperature; Multiple Devices Shown

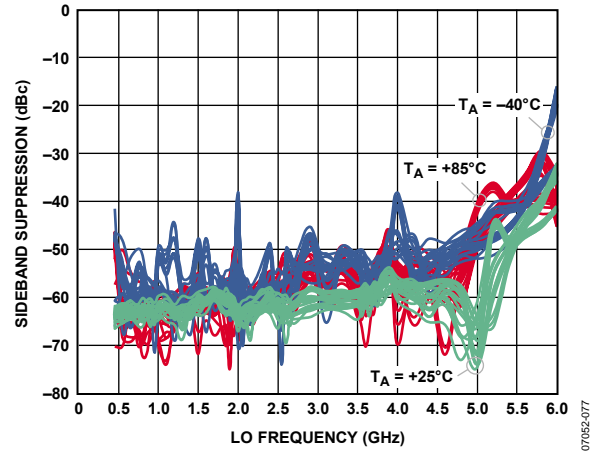

Figure 37. Sideband Suppression vs. LO Frequency ( $f_{LO}$ ) and Temperature After Nulling at 25°C; Multiple Devices Shown

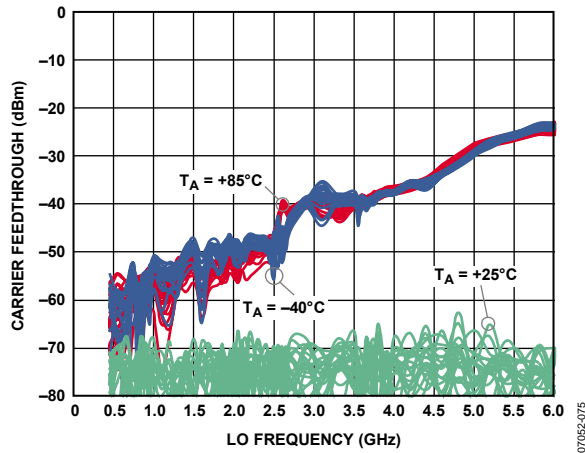

Figure 35. Carrier Feedthrough vs. LO Frequency ( $f_{LO}$ ) and Temperature After Nulling at 25°C; Multiple Devices Shown

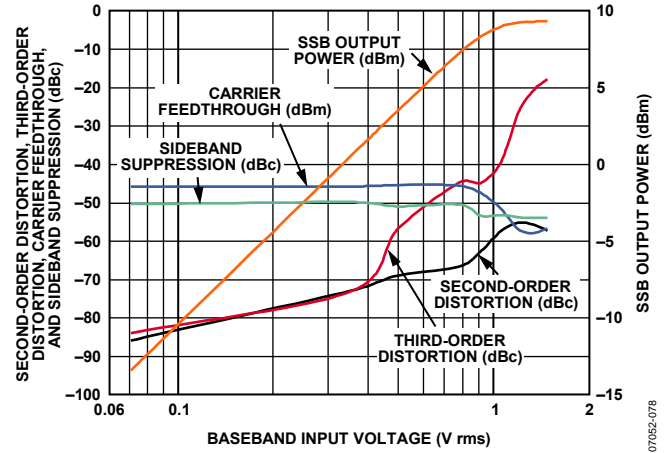

Figure 38. Second- and Third-Order Distortion, Carrier Feedthrough, Sideband Suppression, and SSB  $P_{OUT}$  vs. Baseband Differential Input Level ( $f_{LO} = 900$  MHz)

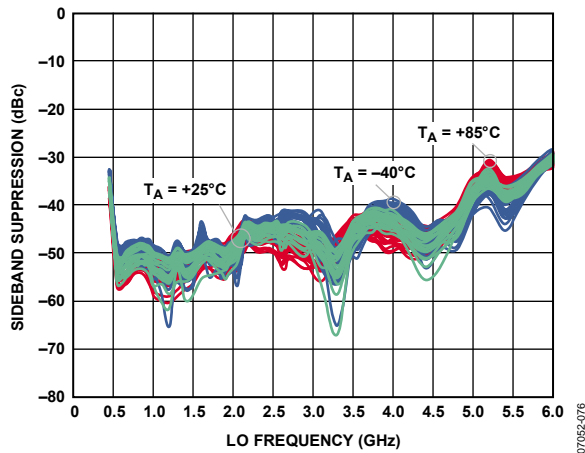

Figure 36. Sideband Suppression vs. LO Frequency ( $f_{LO}$ ) and Temperature; Multiple Devices Shown

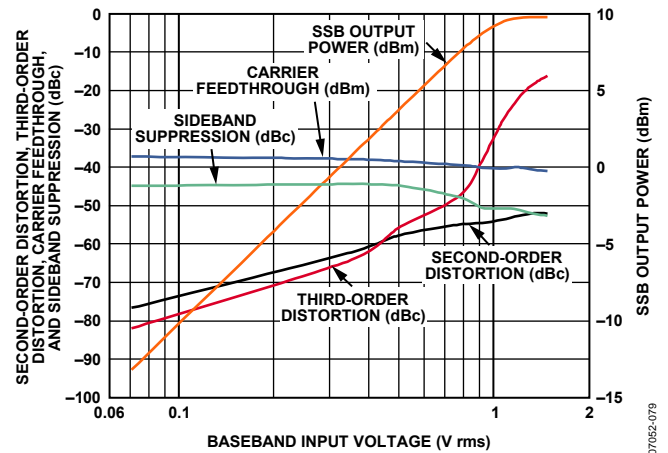

Figure 39. Second- and Third-Order Distortion, Carrier Feedthrough, Sideband Suppression, and SSB  $P_{OUT}$  vs. Baseband Differential Input Level ( $f_{LO} = 2150$  MHz)

## ADL5375-15

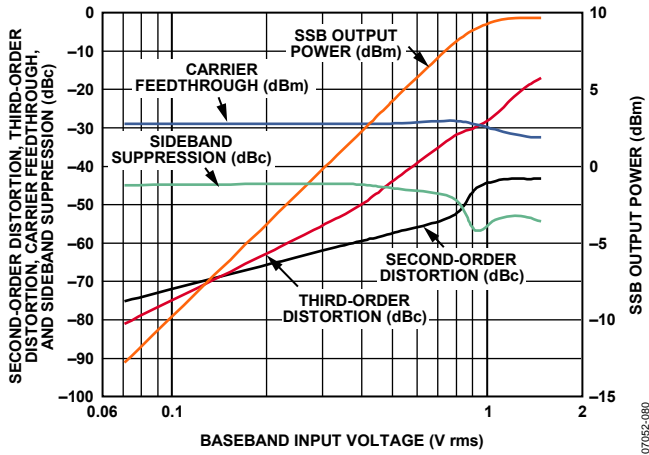

Figure 40. Second- and Third-Order Distortion, Carrier Feedthrough, Sideband Suppression, and SSB  $P_{OUT}$  vs. Baseband Differential Input Level ( $f_{LO} = 3500$  MHz)

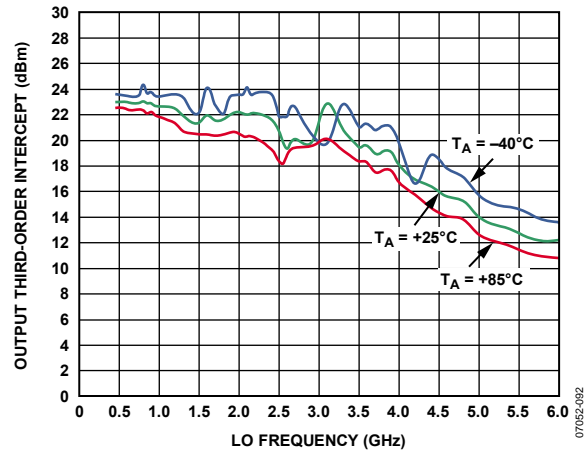

Figure 43. OIP3 vs. LO Frequency ( $f_{LO}$ ) and Temperature ( $P_{OUT} \approx -5$  dBm @  $f_{LO} = 900$  MHz)

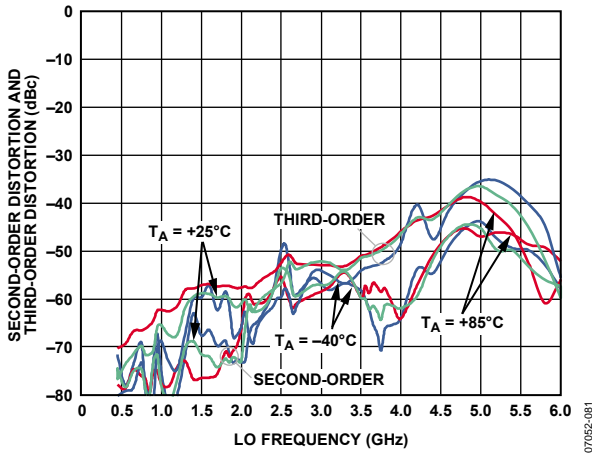

Figure 41. Second- and Third-Order Distortion vs. LO Frequency ( $f_{LO}$ ) and Temperature (Baseband I/Q Amplitude = 1 V p-p Differential)

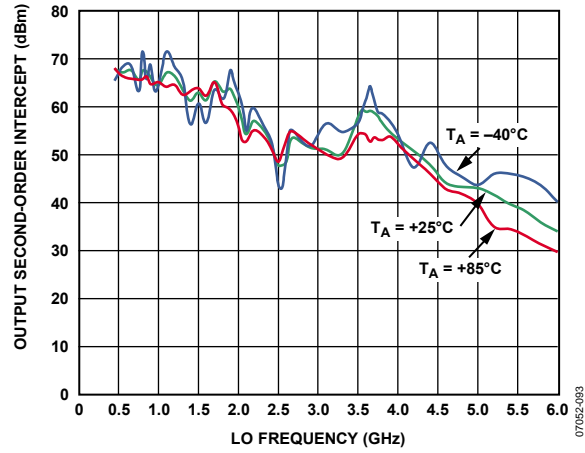

Figure 44. OIP2 vs. LO Frequency ( $f_{LO}$ ) and Temperature ( $P_{OUT} \approx -5$  dBm @  $f_{LO} = 900$  MHz)

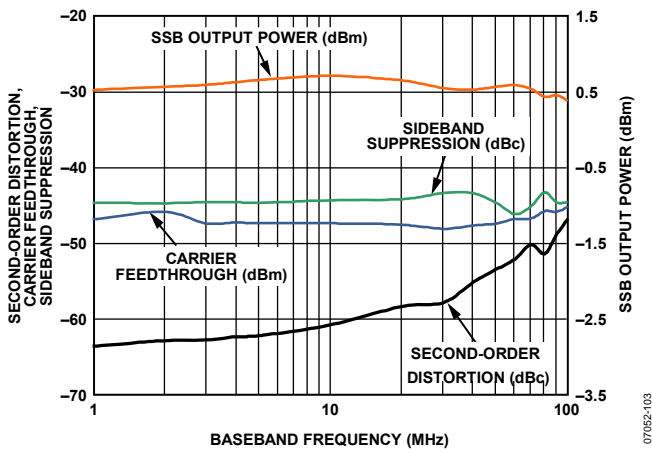

Figure 42. Second-Order Distortion, Carrier Feedthrough, Sideband Suppression, and SSB  $P_{OUT}$  vs. Baseband Frequency ( $f_{BB}$ );  $f_{LO} = 2140$  MHz

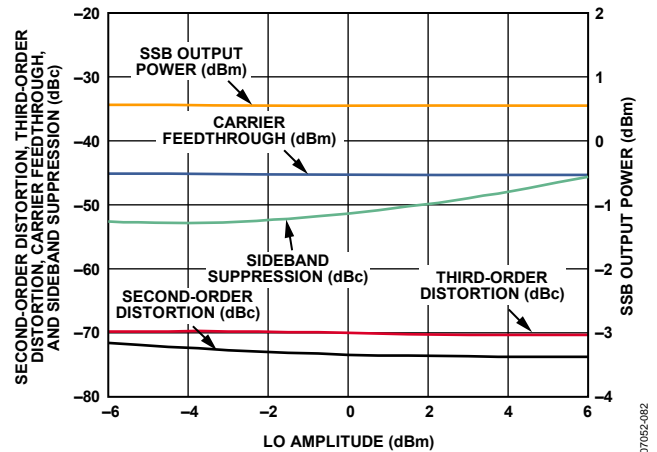

Figure 45. Second- and Third-Order Distortion, Carrier Feedthrough, Sideband Suppression, and SSB  $P_{OUT}$  vs. LO Amplitude ( $f_{LO} = 900$  MHz)



ADL5375-15

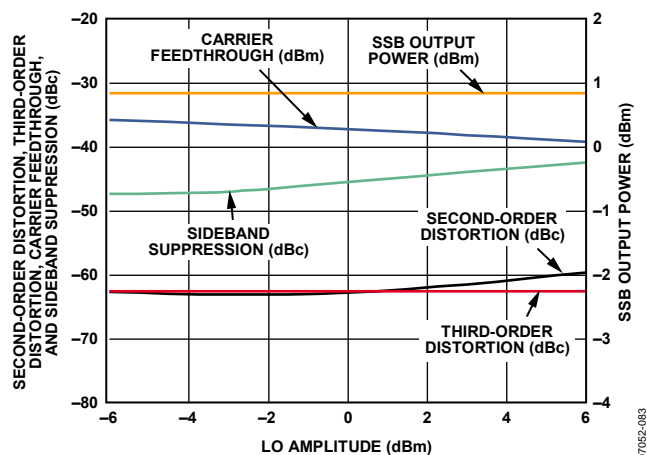

Figure 46. Second- and Third-Order Distortion, Carrier Feedthrough, Sideband Suppression, and SSB  $P_{OUT}$  vs. LO Amplitude ( $f_{LO} = 2150$  MHz)

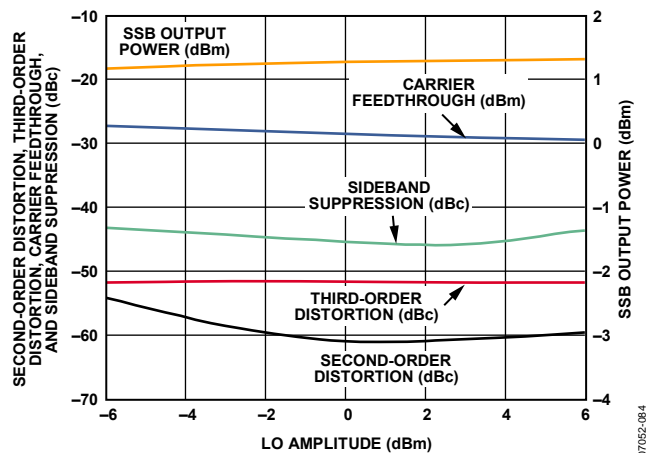

Figure 47. Second- and Third-Order Distortion, Carrier Feedthrough, Sideband Suppression, and SSB  $P_{OUT}$  vs. LO Amplitude ( $f_{LO} = 3500$  MHz)

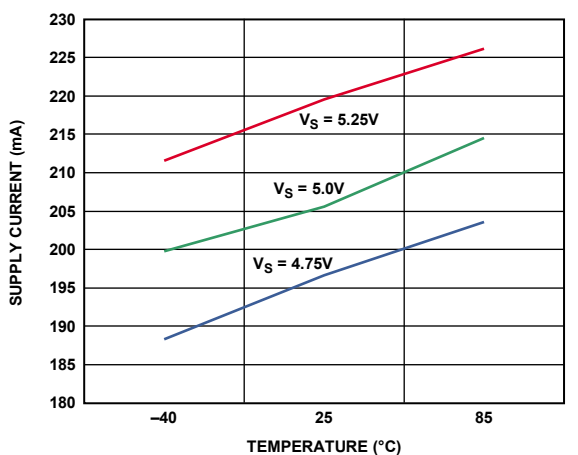

Figure 48. Power Supply Current vs. Temperature

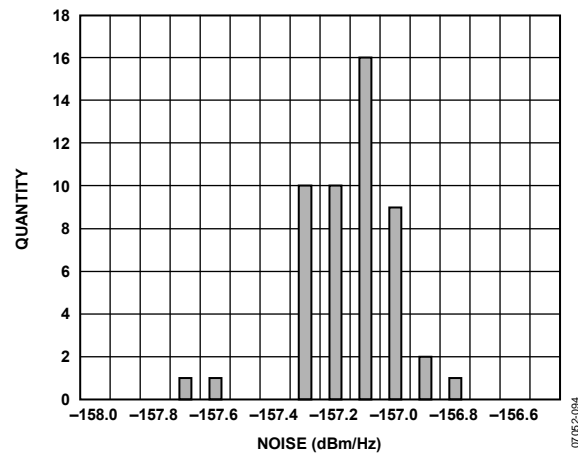

Figure 49. 20 MHz Offset Noise Floor Distribution at  $f_{LO} = 900$  MHz ( $I/Q$  Amplitude = 0 mV p-p with 1500 mV DC Bias)

## ADL5375-15

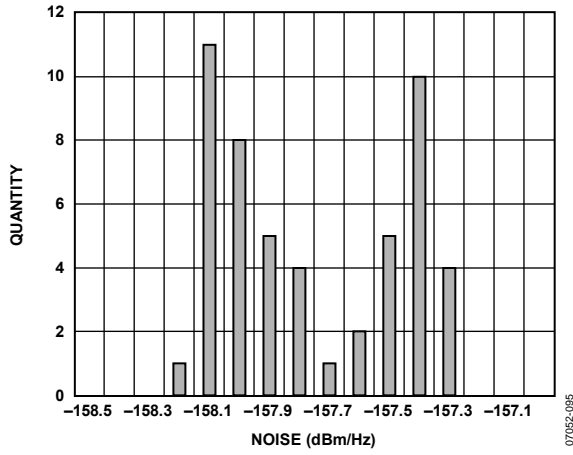

Figure 50. 20 MHz Offset Noise Floor Distribution at  $f_{LO} = 2140$  MHz (I/Q Amplitude = 0 mV p-p with 1500 mV DC Bias)

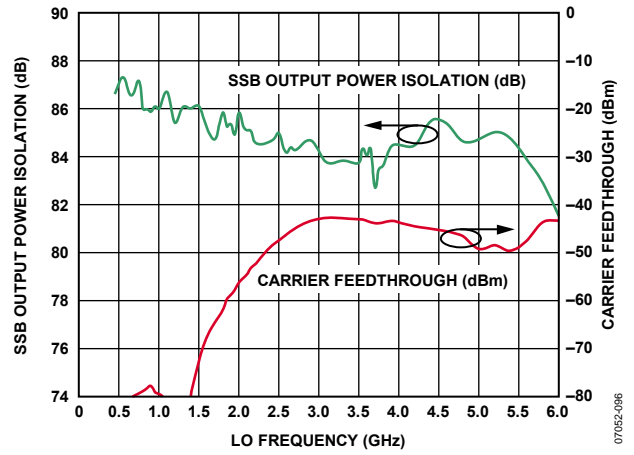

Figure 52. SSB  $P_{OUT}$  Isolation and Carrier Feedthrough with DSOP High

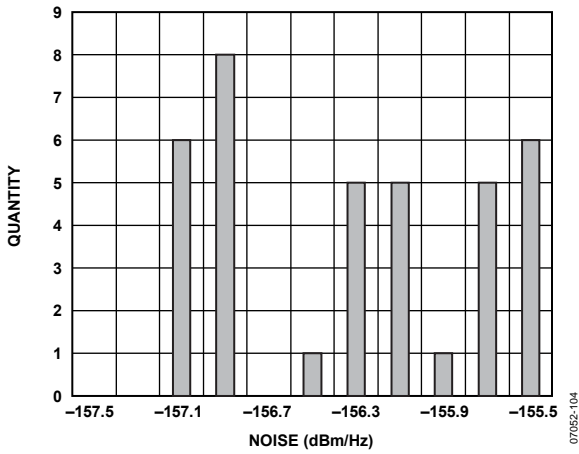

Figure 51. 20 MHz Offset Noise Floor Distribution at  $f_{LO} = 3500$  MHz (I/Q Amplitude = 0 mV p-p with 500 mV DC Bias)

## THEORY OF OPERATION

### CIRCUIT DESCRIPTION

The ADL5375 can be divided into five circuit blocks: the LO interface, the baseband voltage-to-current (V-to-I) converter, the mixers, the differential-to-single-ended (D-to-S) stage, and the bias circuit. A block diagram of the device is shown in Figure 53.

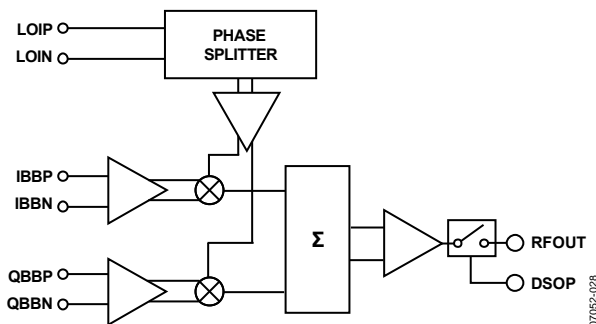

Figure 53. Block Diagram

The LO interface generates two LO signals in quadrature. These signals are used to drive the mixers. The I/Q baseband input signals are converted to currents by the V-to-I stages, which then drive the two mixers. The outputs of these mixers combine to feed the output balun, which provides a single-ended output. The bias cell generates reference currents for the V-to-I stage.

#### LO Interface

The LO interface consists of a polyphase quadrature splitter and a limiting amplifier. The LO input impedance is set by the polyphase splitter. Each quadrature LO signal then passes through a limiting amplifier that provides the mixer with a limited drive signal.

The LO input can be driven single-ended or differentially. For applications above 3 GHz, improved OIP2 and LO leakage may result from driving the LO input differentially.

#### V-to-I Converter

The differential baseband inputs (QBBP, QBNN, IBBN, and IBBP) present a high impedance. The voltages applied to these pins drive the V-to-I stage that converts baseband voltages into currents. The differential output currents of the V-to-I stages feed each of their respective mixers. The dc common-mode voltage at the baseband inputs sets the currents in the two mixer cores. Varying the baseband common-mode voltage influences the current in the mixer and affects overall modulation performance. The recommended dc voltage for the baseband common-mode voltage is 500 mV dc for the ADL5375-05 and 1500 mV for the ADL5375-15.

#### Mixers

The ADL5375 has two double-balanced mixers: one for the in-phase channel (I channel) and one for the quadrature channel (Q-channel). The output currents from the two mixers sum together into an internal load. The signal developed across this load is used to drive the D-to-S stage.

#### D-to-S Stage

The output D-to-S stage consists of an on-chip active balun that converts the differential signal to a single-ended signal. The balun presents 50  $\Omega$  impedance to the output (VOUT). Therefore, no matching network is needed at the RF output for optimal power transfer in a 50  $\Omega$  environment.

#### Bias Circuit

An on-chip band gap reference circuit is used to generate a proportional-to-absolute temperature (PTAT) reference current for the V-to-I stage.

#### DSOP

The DSOP pin can be used to disable the output stage of the modulator. If the DSOP pin is connected to ground or left unconnected, the part operates normally. If the DSOP pin is connected to the positive voltage supply, the output stage is disabled and the LO leakage is also reduced.

## BASIC CONNECTIONS

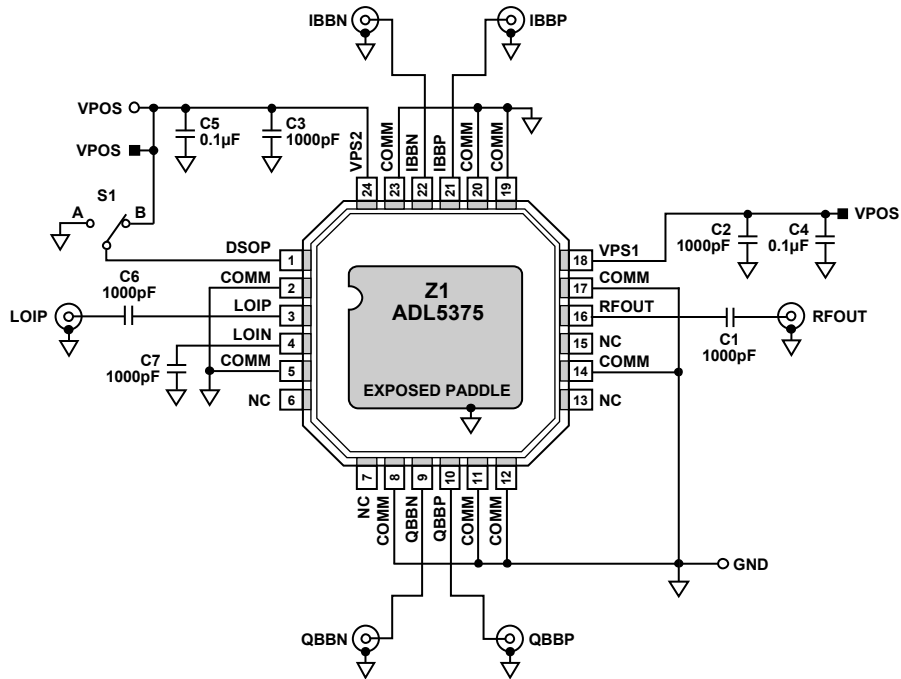

Figure 54. Basic Connections for the ADL5375

Figure 54 shows the basic connections for the ADL5375.

### POWER SUPPLY AND GROUNDING

Pin VPS1 and Pin VPS2 should be connected to the same 5 V source. Each pin should be decoupled with a 100 pF and 0.1 µF capacitor. These capacitors should be located as close as possible to the device. The power supply can range between 4.75 V and 5.25 V.

The ten COMM pins should be tied to the same ground plane through low impedance paths.

The exposed paddle on the underside of the package should also be soldered to a ground plane with low thermal and electrical impedance. If the ground plane spans multiple layers on the circuit board, they should be stitched together with nine vias under the exposed paddle as illustrated in the Evaluation Board section. The AN-772 application note discusses the thermal and electrical grounding of the LFCSP (QFN) package in detail.

### BASEBAND INPUTS

The baseband inputs (IBBP, IBBN, QBBP, and QBBN) should be driven from a differential source. The nominal drive level used in the characterization of the ADL5375 is 1 V p-p differential (or 500 mV p-p on each pin).

All the baseband inputs must be externally dc biased. The recommended common-mode level is dependent on the version of the ADL5375.

- ADL5375-05: 500 mV
- ADL5375-15: 1500 mV

### LO INPUT

The LO input is designed to be driven from a single-ended source. The LO source is ac-coupled through a series capacitor to the LOIP pin while the LOIN pin is ac-coupled to ground through a second capacitor.

The typical LO drive level, which was used for the characterization of the ADL5375, is 0 dBm.

Differential operation is also possible, in which case both sides of the differential LO source should be ac-coupled through a pair of series capacitors to the LOIP and LOIN pins.

### RF OUTPUT

The RF output is available at the RFOUT pin (Pin 16), which can drive a 50 Ω load. The internal balun provides a low dc path to ground. In most situations, the RFOUT pin must be ac-coupled to the load.

07052-029

**OUTPUT DISABLE**

The ADL5375 incorporates an output disable pin feature that shuts down the output amplifier stage to isolate the modulator from the load. This feature is enabled (output is disabled) when the voltage on the DSOP exceeds 2 V. The feature is disabled (output not enabled) when the DSOP pin is either tied to ground or left unconnected.

Asserting DSOP further reduces LO leakage (see Figure 27 and Figure 52) and drives the broadband noise of the device down

to just above the  $KT$  (thermal) noise level. Asserting DSOP also reduces the supply current of the ADL5375 from 200 mA to 131 mA.

The time delay between when the DSOP pin is forced to ground and the output power is restored is approximately 200 ns. The time delay between when the DSOP pin is forced to the positive supply voltage and the output shuts off is under 100 ns.

## OPTIMIZATION

The carrier feedthrough and sideband suppression performance of the ADL5375 can be improved by using optimization techniques.

### Carrier Feedthrough Nulling

Carrier feedthrough results from minute dc offsets that occur between each of the differential baseband inputs. In an ideal modulator, the quantities  $(V_{IBBP} - V_{IBBN})$  and  $(V_{QBBP} - V_{QBNN})$  are equal to zero, which results in no carrier feedthrough. In a real modulator, those two quantities are nonzero and, when mixed with the LO, result in a finite amount of carrier feedthrough. The ADL5375 is designed to provide a minimal amount of carrier feedthrough. Should even lower carrier feedthrough levels be required, minor adjustments can be made to the  $(V_{IBBP} - V_{IBBN})$  and  $(V_{QBBP} - V_{QBNN})$  offsets. The I-channel offset is held constant, while the Q-channel offset is varied until a minimum carrier feedthrough level is obtained. The Q-channel offset required to achieve this minimum is held constant, while the offset on the I-channel is adjusted until a new minimum is reached. Through two iterations of this process, the carrier feedthrough can be reduced to as low as the output noise. The ability to null is sometimes limited by the resolution of the offset adjustment. Figure 55 illustrates the typical relationship between carrier feedthrough and dc offset around the null.

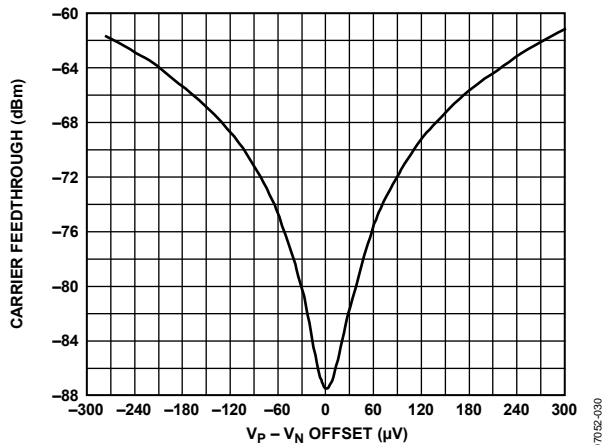

Figure 55. Example of Typical Carrier Feedthrough vs. DC Offset Voltage

Using the ADL5375-05 version as an example, note that throughout the nulling process, the dc bias for the baseband inputs remains at 500 mV. When no offset is applied,

$$V_{IBBP} = V_{IBBN} = 500 \text{ mV, or}$$

$$V_{IBBP} - V_{IBBN} = V_{IOS} = 0 \text{ V}$$

When an offset of  $+V_{IOS}$  is applied to the I-channel inputs,

$$V_{IBBP} = 500 \text{ mV} + V_{IOS}/2, \text{ and}$$

$$V_{IBBN} = 500 \text{ mV} - V_{IOS}/2, \text{ such that}$$

$$V_{IBBP} - V_{IBBN} = V_{IOS}$$

The same applies to the Q-channel. For the ADL5375-15, the same theory applies except that

$$V_{IBBP} = V_{IBBN} = 1500 \text{ mV.}$$

It is often desirable to perform a one-time carrier null calibration. This is usually performed at a given frequency and the radio allowed to operate over a frequency range on each side of that frequency. The nulled carrier feedthrough level degrades somewhat as the LO frequency is moved away from the frequency at which the null was performed. This variation is very small across a 30 MHz or 60 MHz cellular band, however. This small variation is due to the effects of LO-to-RF output leakage around the package and on the board as the frequency changes. Despite the degradation, the LO leakage can be expected to be better than when no nulling is performed.

### Sideband Suppression Optimization

Sideband suppression results from relative gain and relative phase offsets between the I-channel and Q-channel and can be suppressed through adjustments to those two parameters. Figure 56 illustrates how sideband suppression is affected by the gain and phase imbalances.

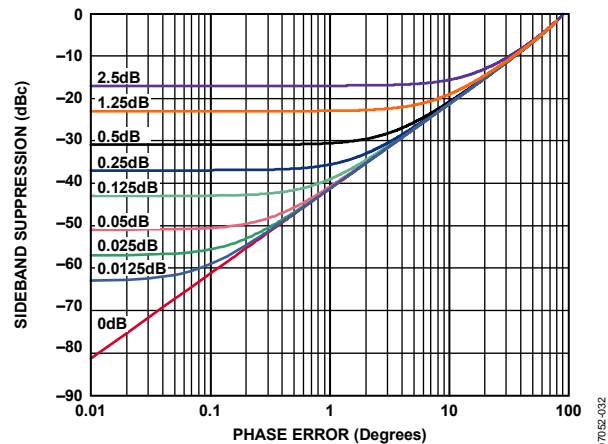

Figure 56. Sideband Suppression vs. Quadrature Phase Error for Various Quadrature Amplitude Offsets

Figure 56 underlines the fact that adjusting only one parameter improves the sideband suppression only to a point, unless the other parameter is also adjusted. For example, if the amplitude offset is 0.25 dB, improving the phase imbalance by better than  $1^\circ$  does not yield any improvement in the sideband suppression. For optimum sideband suppression, an iterative adjustment between phase and amplitude is required.

The sideband suppression nulling can be performed either through adjusting the gain for each channel or through the modification of the phase and gain of the digital data coming from the baseband signal processor.

## APPLICATIONS INFORMATION

### DAC MODULATOR INTERFACING

#### Driving the ADL5375-05 with a TXDAC®

The ADL5375-05 is designed to interface with minimal components to members of the Analog Devices, Inc. TxDAC families. These dual-channel differential current output DACs feature an output current swing from 0 mA to 20 mA. The interface described in this section can be used with any DAC that has a similar output.

An example of an interface using the AD9779 TxDAC is shown in Figure 57. The baseband inputs of the ADL5375-05 require a dc bias of 500 mV. The average output current on each of the outputs of the AD9779 is 10 mA. Therefore, a single 50 Ω resistor to ground from each of the DAC outputs results in an average current of 10 mA flowing through each of the resistors, thus producing the desired 500 mV dc bias for the inputs to the ADL5375-05.

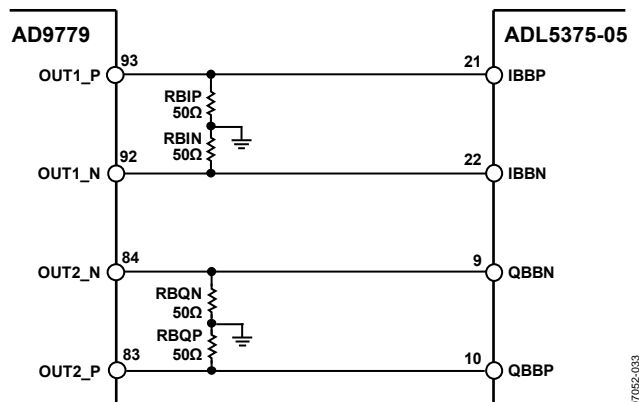

Figure 57. Interface Between the AD9779 and ADL5375-05 with 50 Ω Resistors to Ground to Establish the 500 mV DC Bias for the ADL5375-05 Baseband Inputs

The AD9779 output currents have a swing that ranges from 0 mA to 20 mA. With the 50 Ω resistors in place, the ac voltage swing going into the ADL5375-05 baseband inputs ranges from 0 V to 1 V. A full-scale sine wave out of the AD9779 can be described as a 1 V p-p single-ended (or 2 V p-p differential) sine wave with a 500 mV dc bias.

#### Limiting the AC Swing

There are situations in which it is desirable to reduce the ac voltage swing for a given DAC output current. This can be achieved through the addition of another resistor to the interface. This resistor is placed in the shunt between each side of the differential pair, as shown in Figure 58. It has the effect of reducing the ac swing without changing the dc bias already established by the 50 Ω resistors.

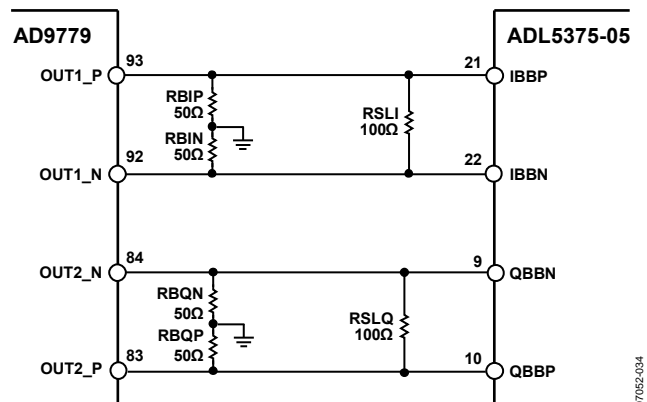

Figure 58. AC Voltage Swing Reduction Through the Introduction of a Shunt Resistor Between Differential Pair

The value of this ac voltage swing limiting resistor is chosen based on the desired ac voltage swing. Figure 59 shows the relationship between the swing-limiting resistor and the peak-to-peak ac swing that it produces when 50 Ω bias-setting resistors are used.

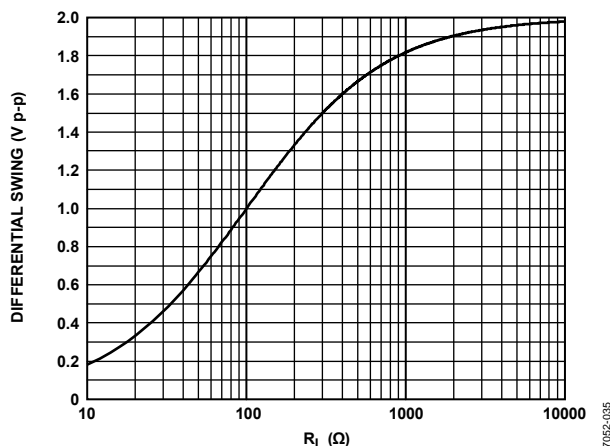

Figure 59. Relationship Between the AC Swing-Limiting Resistor and the Peak-to-Peak Voltage Swing with 50 Ω Bias-Setting Resistors

#### Filtering

It is necessary to place an antialiasing filter between the DAC and modulator to filter out Nyquist images and broadband DAC noise. The interface for setting up the biasing and ac swing discussed in the Limiting the AC Swing section lends itself well to the introduction of such a filter. The filter can be inserted between the dc bias setting resistors and the ac swing-limiting resistor. Doing so establishes the input and output impedances for the filter.

Figure 60 shows a third-order, Bessel low-pass filter with a 3 dB frequency of 10 MHz. Matching input and output impedances make the filter design easier, so the shunt resistor chosen is 100 Ω, producing an ac swing of 1 V p-p differential. The frequency response of this filter is shown in Figure 61.

# ADL5375

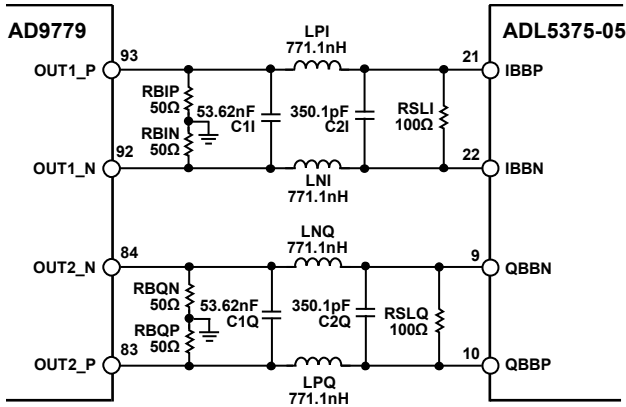

Figure 60. DAC Modulator Interface with 10 MHz Third-Order, Bessel Filter

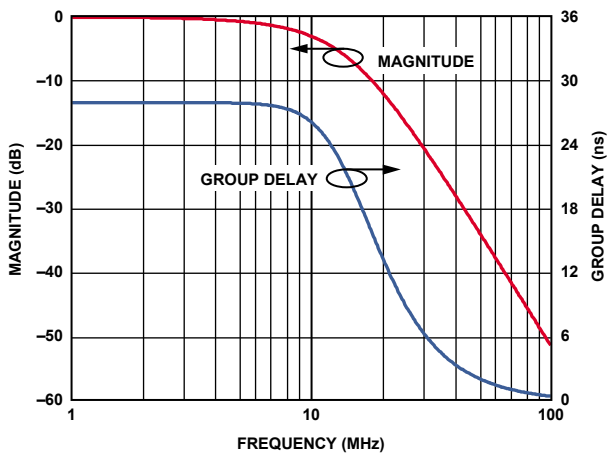

Figure 61. Frequency Response for DAC Modulator Interface with 10 MHz Third-Order, Bessel Filter

## Driving the ADL5375-15 with a TXDAC

The ADL5375-15 requires a 1500 mV dc bias and therefore requires a slightly more complex interface that performs a dc level shift on the baseband signals. It is necessary to level-shift the DAC output from a 500 mV dc bias to the 1500 mV dc bias that the ADL5375-15 requires.

Level-shifting can be achieved with either a passive network or an active circuit. A passive network of resistors is shown in Figure 62. In this network, the dc bias of the DAC remains at 500 mV while the input to the ADL5375-15 is 1500 mV. It should be noted that this passive level-shifting network introduces approximately 2 dB of loss in the ac signal.

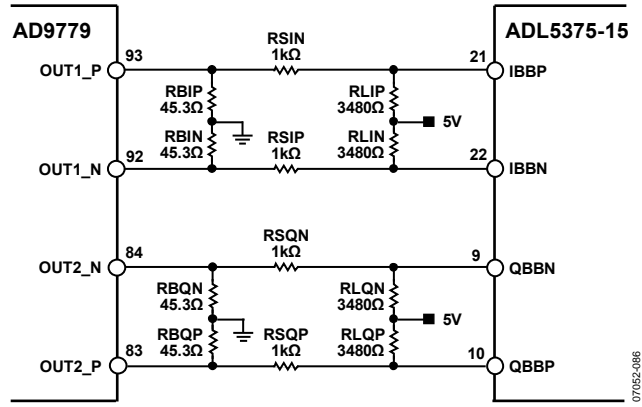

Figure 62. Passive Level-Shifting Network For Biasing ADL5375-15 from TxDAC

The active level shifting circuit involves the use of the ADA4938 dual-differential amplifier. This device has a VO<sub>CM</sub> pin that sets the output dc bias. Through this pin, the output common-mode of the amplifier can be easily set to the requisite 1.5 V for biasing the ADL5375-15 baseband inputs.

## USING THE AD9779 AUXILIARY DAC FOR CARRIER FEEDTHROUGH NULLING

The AD9779 features an auxiliary DAC that can be used to inject small currents into the differential outputs for each main DAC channel. This feature can be used to produce the small offset voltages necessary to null out the carrier feedthrough from the modulator. Figure 63 shows the interface required to use the auxiliary DACs, which adds four resistors to the interface.

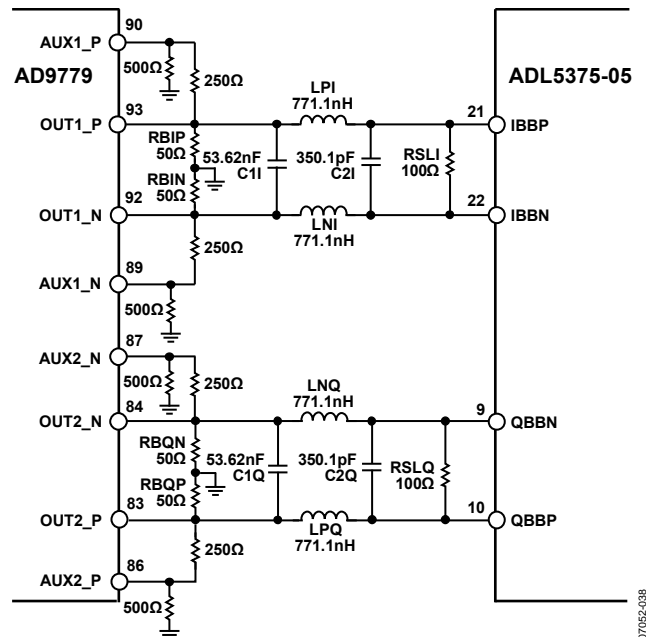

Figure 63. DAC Modulator Interface with Auxiliary DAC Resistors



### GSM/EDGE OPERATION

The performance of the ADL5375 in a GSM/EDGE environment is shown in this section.

Figure 64 illustrates the 6 MHz offset noise of the ADL5375-05 and the ADL5375-15 vs. output power at 940 MHz. Figure 65 demonstrates how the 6 MHz offset noise is affected by variations in LO drive level for both versions of the ADL5375 at 940 MHz.

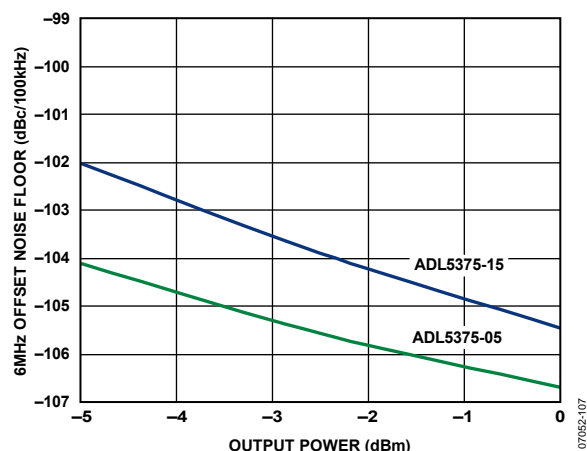

Figure 64. GSM/Edge (8-PSK) 6 MHz Offset Noise at 940 MHz vs. Output Power, LO Drive = 0 dBm

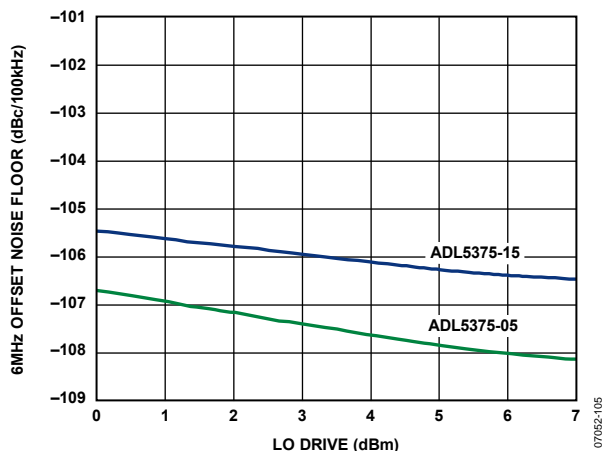

Figure 65. GSM/Edge (8-PSK) 6 MHz Offset Noise at 940 MHz vs. LO Drive, Output Power = 0 dBm

### W-CDMA OPERATION

The ADL5375 is suitable for W-CDMA operation. Figure 66 and Figure 67 show the adjacent and alternate channel power ratios for the ADL5375-05 and ADL5375-15, respectively, at an LO frequency of 2140 MHz.

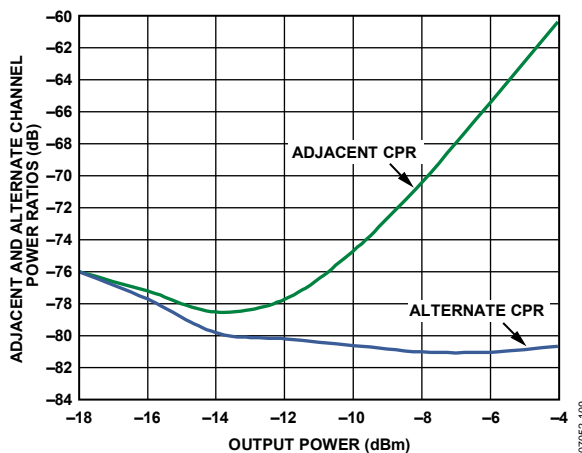

Figure 66. ADL5375-05 Single-Carrier W-CDMA Adjacent and Alternate Channel Power vs. Output Power at 2140 MHz; LO Power = 0 dBm

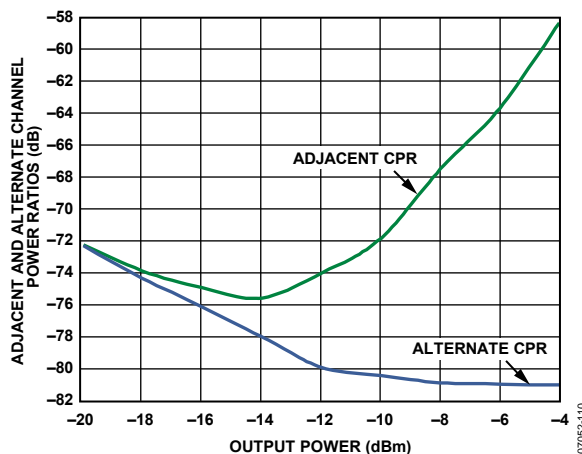

Figure 67. ADL5375-15 Single-Carrier W-CDMA Adjacent and Alternate Channel Power vs. Output Power at 2140 MHz; LO Power = 0 dBm

Figure 66 and Figure 67 show that both versions of the ADL5375 are able to deliver about or better than -72 dB ACPR at an output power of -10 dBm.

Figure 68 and Figure 69 illustrate the sensitivity of the EVM to variations in LO drive at 2140 MHz for the ADL5375-05 and ADL5375-15 respectively.

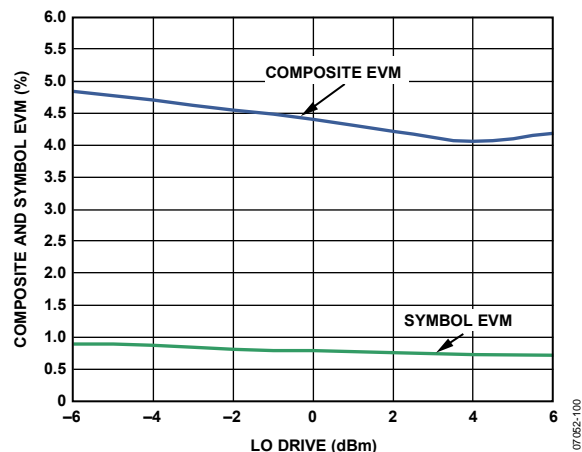

Figure 68. ADL5375-05 Single Carrier W-CDMA Composite and Symbol EVM vs. LO Drive at 2140 MHz; Output Power = -10 dBm

# ADL5375

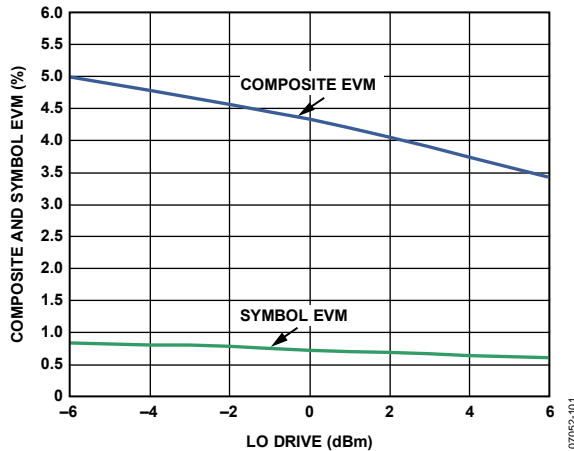

Figure 69. ADL5375-15 Single Carrier W-CDMA Composite and Symbol EVM vs. LO Drive at 2140 MHz; Output Power = -10 dBm

The EVM exhibits moderate improvements with an increase in the LO drive.

## LO GENERATION USING PLLS

Analog Devices has a line of PLLs that can be used for generating the LO signal. Table 4 lists the PLLs together with their maximum frequency and phase noise performance.

Table 4. Analog Devices PLL Selection

Part	Frequency, $f_{IN}$ (MHz)	Phase Noise @ 1 kHz Offset and 200 kHz PFD (dBc/Hz)
ADF4110	550	-91 @ 540 MHz
ADF4111	1200	-87 @ 900 MHz
ADF4112	3000	-90 @ 900 MHz
ADF4113	4000	-91 @ 900 MHz
ADF4116	550	-89 @ 540 MHz
ADF4117	1200	-87 @ 900 MHz
ADF4118	3000	-90 @ 900 MHz

The ADF4360-x comes as a family of chips with nine operating frequency ranges. Choose chips depending on the local oscillator frequency required. While the use of the integrated synthesizer may come at the expense of slightly degraded noise performance from the ADL5375, it can be a cheaper alternative to a separate PLL and VCO solution. Table 5 shows the options available.

Table 5. ADF4360-x Family Operating Frequencies

Part	Output Frequency Range (MHz)
ADF4360-0	2400 to 2725
ADF4360-1	2050 to 2450
ADF4360-2	1850 to 2150
ADF4360-3	1600 to 1950
ADF4360-4	1450 to 1750
ADF4360-5	1200 to 1400
ADF4360-6	1050 to 1250
ADF4360-7	350 to 1800
ADF4360-8	65 to 400

## TRANSMIT DAC OPTIONS

The AD9779 recommended in the previous sections of this data sheet is by no means the only DAC that can be used to drive the ADL5375. There are other appropriate DACs, depending on the level of performance required. Table 6 lists the dual TxDAC offered by Analog Devices.

Table 6. Dual TxDAC Selection

Part	Resolution (Bits)	Update Rate (MSPS Minimum)
AD9709	8	125
AD9761	10	40
AD9763	10	125
AD9765	12	125
AD9767	14	125
AD9773	12	160
AD9775	14	160
AD9777	16	160
AD9776	12	1000
AD9778	14	1000
AD9779	16	1000

All DACs listed have nominal bias levels of 0.5 V and use the same simple DAC modulator interface that is shown in Figure 60.

## MODULATOR/DEMULATOR OPTIONS

Table 7 lists other Analog Devices modulators and demodulators.

Table 7. Modulator/Demodulator Options

Part No.	Modulator/Demodulator	Frequency Range (MHz)	Comments
AD8345	Modulator	140 to 1000	External quadrature
AD8346	Modulator	800 to 2500	
AD8349	Modulator	700 to 2700	
ADL5390	Modulator	20 to 2400	
ADL5385	Modulator	50 to 2200	
ADL5370	Modulator	300 to 1000	
ADL5371	Modulator	500 to 1500	
ADL5372	Modulator	1500 to 2500	
ADL5373	Modulator	2300 to 3000	
ADL5374	Modulator	3000 to 4000	
AD8347	Demodulator	800 to 2700	
AD8348	Demodulator	50 to 1000	
ADL5387	Demodulator	50 to 2000	
AD8340	Vector modulator	700 to 1000	
AD8341	Vector modulator	1500 to 2400	

## EVALUATION BOARD

Populated RoHS-compliant evaluation boards are available for evaluation of both versions of the ADL5375. The ADL5375 package has an exposed paddle on the underside. This exposed paddle should be soldered to the board for good thermal and electrical grounding. The evaluation board is designed without any components on the underside, so heat can be applied to the

underside for easy removal and replacement of the ADL5375 should it be necessary.

Both versions of the ADL5375 share the same evaluation board and schematic. To differentiate the boards from each other, the silkscreen on the underside of the board has a table that is marked to indicate which version (-05 or -15) is populated on the board.

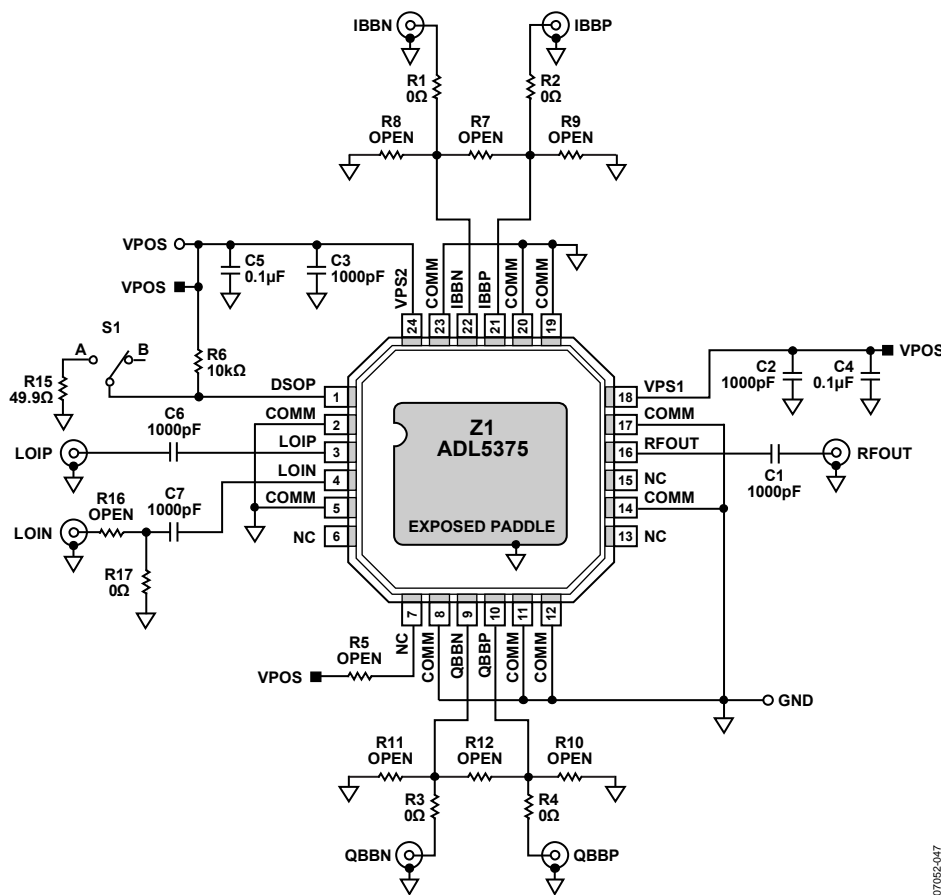

Figure 70. ADL5375 Evaluation Board Schematic

Table 8. Evaluation Board Description and Configuration Options

Component	Description	Default Condition/Option Settings
VPOS, GND Test Points	Power Supply and Ground test points for clip leads	Red = 5 V, black = GND
S1 Switch	DSOP Output Disable Select	Position A = output enabled Position B = output disabled
R1 to R4, R7 to R12	Baseband input filtering components	R1 to R4 = 0 Ω (0402) R7 to R12 = open (0402)
LOIP SMA, R16, R17	Single-ended local oscillator input	R16 = open, R17 = 0 Ω (0402)
LOIN SMA, R16, R17	Optional SMA for differential LO input	R16 = 0 Ω (0402), R17 = open

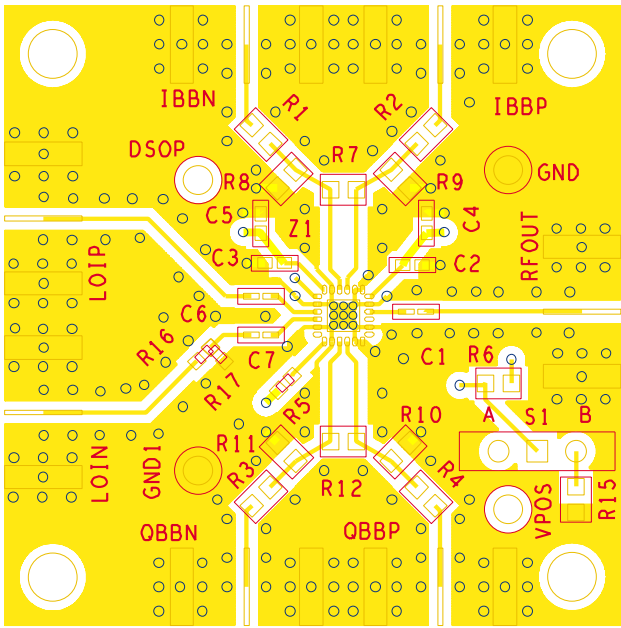

Figure 71. Evaluation Board Layout, Top Layer

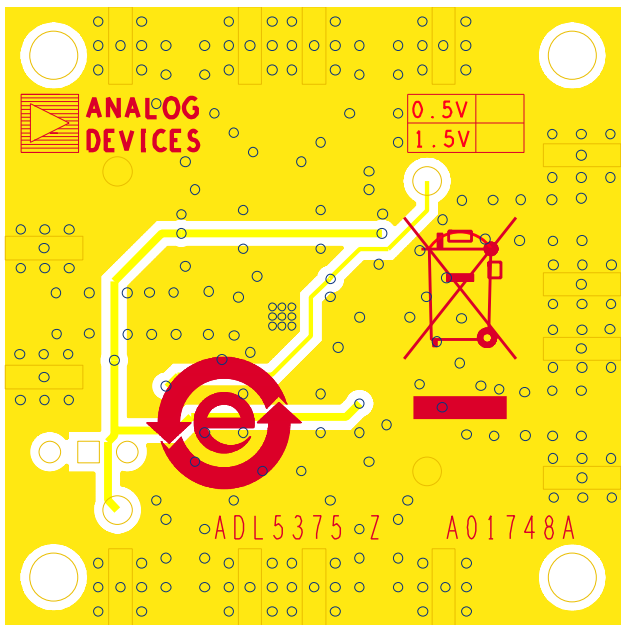

Figure 72. Evaluation Board Layout, Bottom Layer

### THERMAL GROUNDING AND EVALUATION BOARD LAYOUT

The package for the ADL5375 features an exposed paddle on the underside that should be well soldered to a low thermal and electrical impedance ground plane. This paddle is typically soldered to an exposed opening in the solder mask on the evaluation board. Figure 73 illustrates the dimensions used in the layout of the ADL5375 footprint on the ADL5375 evaluation board (1 mil. = 0.0254 mm).

Notice the use of nine via holes on the exposed paddle. These ground vias should be connected to all other ground layers on the evaluation board to maximize heat dissipation from the device package.

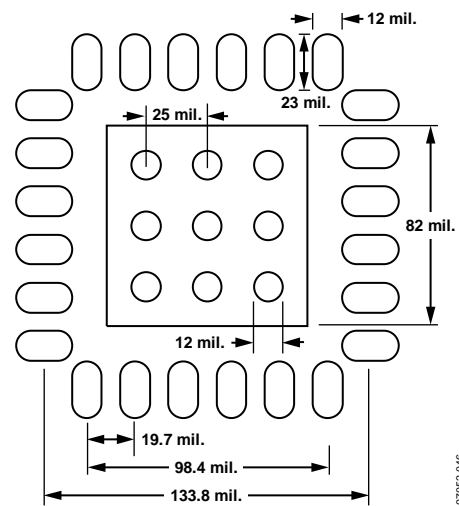

Figure 73. Dimensions for Evaluation Board Layout for the ADL5375 Package

Under these conditions, the thermal impedance of the ADL5375 was measured to be approximately 30°C/W in still air.

## CHARACTERIZATION SETUP

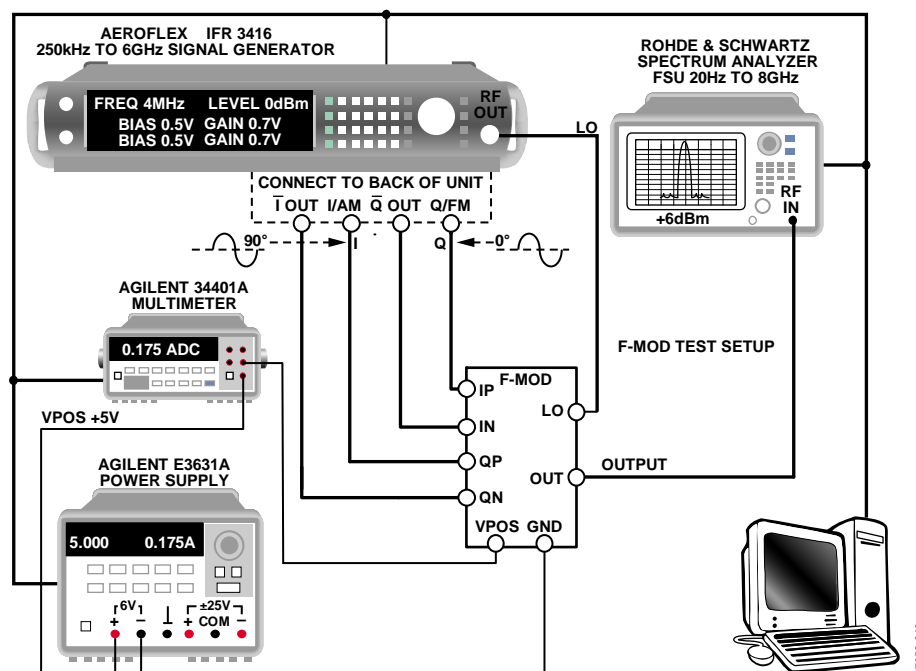

Figure 74. Characterization Bench Setup

The primary setup used to characterize the ADL5375 is shown in Figure 74. This setup was used to evaluate the product as a single-sideband modulator. The Aeroflex signal generator supplied the LO and differential I and Q baseband signals to the device under test (DUT). The typical LO drive was 0 dBm. The I-channel is driven by a sine wave, and the Q-channel is driven by a cosine wave. The lower sideband is the single-sideband (SSB) output.

The majority of characterization for the ADL5375 was performed using a 1 MHz sine wave signal with a 500 mV (ADL5375-05) or 1500 mV (ADL5375-15) common-mode voltage applied to the baseband signals of the DUT. The baseband signal path was calibrated to ensure that the  $V_{IOS}$  and  $V_{QOS}$  offsets on the baseband inputs were minimized as close as possible to 0 V before connecting to the DUT. See the Carrier Feedthrough Nulling section for the definitions of  $V_{IOS}$  and  $V_{QOS}$ .

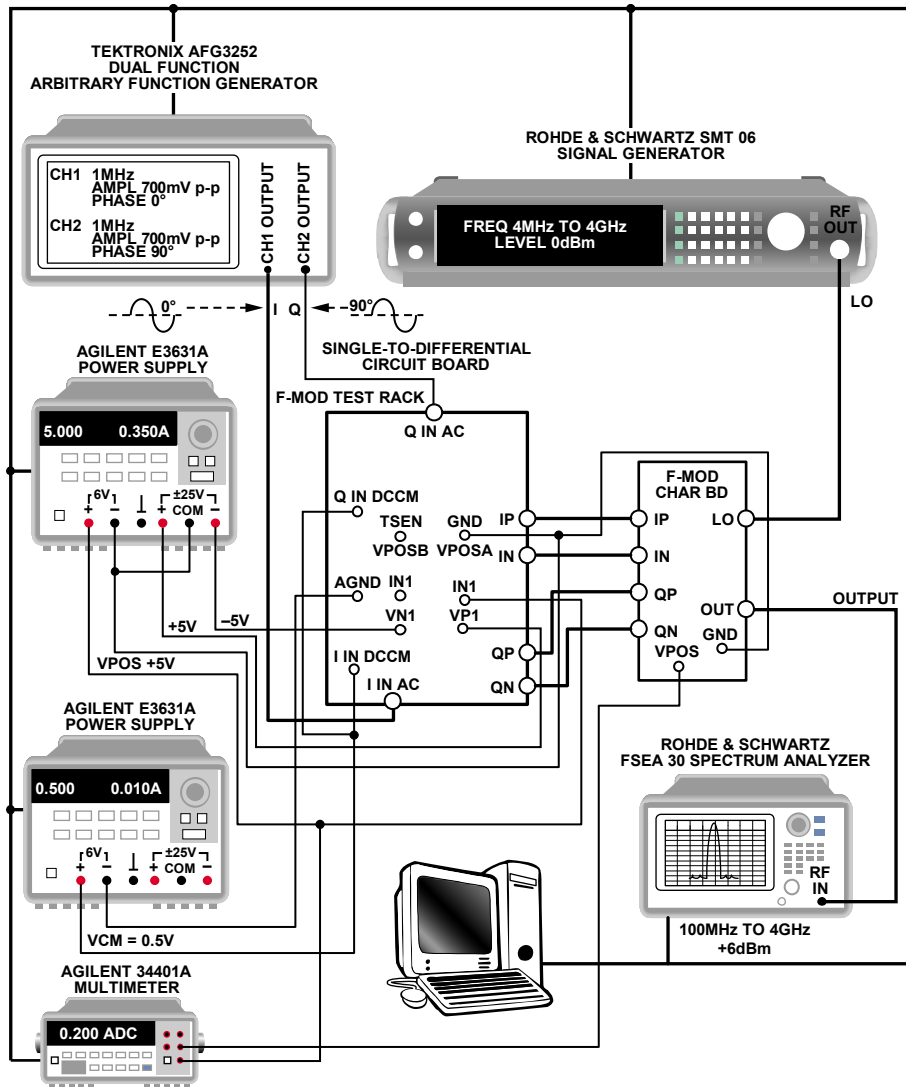
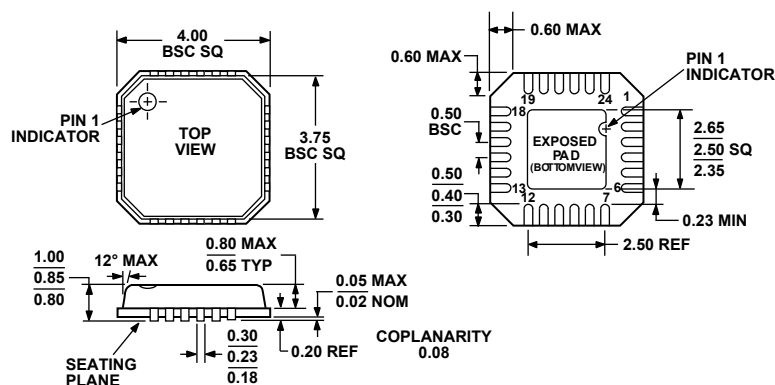

Figure 75. Setup for Baseband Frequency Sweep and Undesired Sideband Nulling

The setup used to evaluate baseband frequency sweep and undesired sideband nulling of the ADL5375 is shown in Figure 75. The interface board has circuitry that converts the single-ended I input and Q input from the arbitrary function generator to differential I and Q baseband signals with a dc bias of 500 mV

(ADL5375-05) or 1500mV (ADL5375-15). Undesired sideband nulling was achieved through an iterative process of adjusting amplitude and phase on the Q-channel. See the Sideband Suppression Optimization section for a detailed description on sideband nulling.

## OUTLINE DIMENSIONS



COMPLIANT TO JEDEC STANDARDS MO-220-VGGD-8

Figure 76. 24-Lead Lead Frame Chip Scale Package [LFCSP\_VQ]  
 4 mm × 4 mm Body, Very Thin Quad  
 (CP-24-3)  
 Dimensions shown in millimeters

## ORDERING GUIDE

Model	Temperature Range	Package Description	Package Option	Ordering Quantity
ADL5375-05ACPZ-R7 <sup>1</sup>	-40°C to +85°C	24-Lead LFCSP_VQ, 7" Tape and Reel	CP-24-3	1,500
ADL5375-05ACPZ-WP <sup>1</sup>	-40°C to +85°C	24-Lead LFCSP_VQ, Waffle Pack	CP-24-3	64
ADL5375-05-EVALZ <sup>1</sup>		Evaluation Board		
ADL5375-15ACPZ-R7 <sup>1</sup>	-40°C to +85°C	24-Lead LFCSP_VQ, 7" Tape and Reel	CP-24-3	1,500
ADL5375-15ACPZ-WP <sup>1</sup>	-40°C to +85°C	24-Lead LFCSP_VQ, Waffle Pack	CP-24-3	64
ADL5375-15-EVALZ <sup>1</sup>		Evaluation Board		

<sup>1</sup> Z = RoHS Compliant Part/Evaluation Board.

**ADL5375**

**NOTES**