

High-precision Sensing with Auto- and Manual-tuning

Solves All the Problems of Conventional Models

- Suitable for high-precision positioning using the fine sensitivity adjustment function.
- Manual-tuning allows threshold adjustments while sensing objects are moving.
- Operation conditions can be seen at a glance through the incident level indicators and threshold indicators.
- Auto-tuning feature incorporates an automatic sensitivity compensation function ensuring an optimum margin for changes in sensing objects or ambient environments.
- Offers the longest sensing distance.
- Newly added mark-sensing models (blue LED).



Ordering Information

■ Amplifier Units

Item		General-purpose models		Timer-function models		Mark-sensing models
		NPN	PNP	NPN	PNP	
Output						NPN
Model		E3X-NH11	E3X-NH41	E3X-NH21	E3X-NH51	E3X-NHB11
Appearance						
Light source (Wave length)		Red LED (680 nm)				Blue LED (470 nm)
Power supply voltage		12 to 24 VDC ±10%, ripple (p-p) 10% max.				
Current consumption		75 mA max.				
Output	Control output	NPN open collector, load current: 50 mA max., residual voltage: 1 V max.	PNP open collector, load current: 50 mA max., residual voltage: 1 V max.	NPN open collector, load current: 50 mA max., residual voltage: 1 V max.	PNP open collector, load current: 50 mA max., residual voltage: 1 V max.	NPN open collector, load current: 50 mA max., residual voltage: 1 V max.
	Alarm output					
Circuit protection		Output short-circuit, reverse polarity, mutual interference prevention				
Response time		1 ms max. for operation and reset respectively				
Sensitivity setting		Teaching method				
Fine sensitivity adjustment		Automatic or manual fine threshold adjustment (13 levels)				
Timer function		---		OFF-delay timer set to 40 ms		---

■ Fiber Units

Through-beam/Slot Sensors



Indicates models that allow free cutting. Models without this mark do not allow free cutting.

■ : E3X-NH











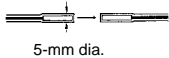





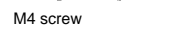





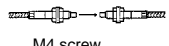

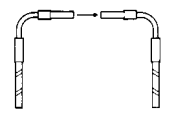

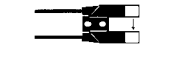

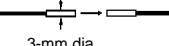

□ : E3X-NHB

Application	Features	Appearance	Sensing distance (mm) * (Values in parentheses: when using the E39-F1 Lens Unit)	Standard object (min. sensing object: opaque)	Model	Permissible bending radius
Long distance	M4		700 (2,000) 90 (250)	1.4-mm dia. (0.06-mm dia.)	E32-T11L	25 mm
	3 dia.		700 90		E32-T12L	
	M3		200	0.9-mm dia. (0.04-mm dia.)	E32-T21L	
	2 dia.; small diameter		200		E32-T22L	
	M14; with lens; ideal for explosion-proof applications		14,000 2,000	10-mm dia. (0.2-mm dia.)	E32-T17L	
General-purpose	M4		400 (3,000) 55 (420)	1.0-mm dia. (0.04-mm dia.)	E32-TC200	25 mm
	M3; possible to mount the reflective side-view conversion attachment E39-F5		360 55		E32-TC200A	
	M3; for detecting minute sensing objects		100	0.5-mm dia. (0.04-mm dia.)	E32-TC200E	
Thin fiber	2 dia.; for detecting minute sensing objects		100	0.5-mm dia. (0.04-mm dia.)	E32-T22	25 mm
	1.2 dia.; with sleeve		400 55	1.0-mm dia. (0.04-mm dia.)	E32-TC200B E32-TC200B4	
	0.9 dia.; with sleeve		100		0.5-mm dia. (0.04-mm dia.)	
Flexible (resists breaking) (R1)	Possible to bend like electric wires (R1);		280 (2,100)	1-mm dia. (0.1-mm dia.)	E32-T11R	1 mm
			60	0.5-mm dia. (0.1-mm dia.)	E32-T21R	
Flexible (resists breaking) (R4);	Ideal for mounting on moving sections (R4)		360 50	1.0-mm dia. (0.04-mm dia.)	E32-T11	4 mm
			100	0.5-mm dia. (0.04-mm dia.)	E32-T21	
Side-view	Long distance; space-saving		240 30	1.0-mm dia. (0.08-mm dia.)	E32-T14L	25 mm
	Suitable for detecting minute sensing objects		90	0.5-mm dia. (0.04-mm dia.)	E32-T24	
	Screw-mounting type		1,800 200	4.0-mm dia. (0.08-mm dia.)	E32-T14	

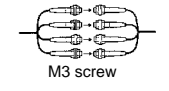
- Note:**
- For common specifications of the Fiber Unit, refer to page 6.
 - The size of standard sensing object is the same as the fiber core diameter (lens diameter for models with lens).
 - The sensing distance of the minimum sensing object indicates the rated sensing distance unless otherwise specified.
 - Curled-cord models are also available for through-beam and reflective models.
- * Sensing distance indicates values for white paper.

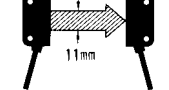
 Indicates models that allow free cutting. Models without this mark do not allow free cutting.

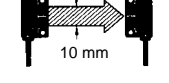
 : E3X-NH  : E3X-NHB











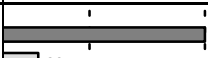

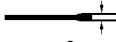















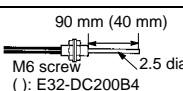



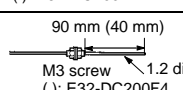



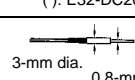













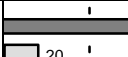

Application	Features	Appearance	Sensing distance (mm) *1 (Values in parentheses: when using the E39-F1 Lens Unit)	Standard object (min. sensing object: opaque)	Model	Permissible bending radius
Chemical-resistant	Teflon-covered ^{*4} ; withstands chemicals and harsh environments (operating ambient temperature: -30°C to 70°C)	 5-mm dia.	 1,600 220	4.0-mm dia. (0.12-mm dia.)	E32-T12F 	40 mm
	Teflon covered ^{*4} ; side-view; withstands chemicals and harsh environments (operating ambient temperature: -30°C to 70°C)	 5-mm dia.	 200	3.0-mm dia. (0.12-mm dia.)	E32-T14F 	
Heat-resistant	Resists 150°C ^{*3} ; fiber sheath material: fluoro-resin (operating ambient temperature: -40°C to 150°C)	 M4 screw	 400 35	1.5-mm dia. (0.4-mm dia.)	E32-T51 	35 mm
	Side-view; resists 150°C ^{*3} ; suitable for detecting minute sensing objects; fiber sheath material: fluoro-resin (operating ambient temperature: -40°C to 150°C)	 2-mm dia.	 130	1.0-mm dia. (0.16-mm dia.)	E32-T54 	
	Resists 300°C ^{*5} , with spiral tube; high mechanical strength; fiber sheath material: stainless steel (operating ambient temperature: -40°C to 300°C)	 M4 screw	 300 (3,000)	1.0-mm dia. (0.12-mm dia.)	E32-T61	25 mm
	Resists 200°C ^{*5} ; L-shaped; fiber sheath material: stainless steel		 700	1.7-mm dia. (0.12-mm dia.)	E32-T84S	
Slot	Suitable for film sheet detection; no optical axis adjustment required; easy to mount		 10	4.0-mm dia. (0.16-mm dia.)	E32-G14 	25 mm
Narrow vision field	Suitable for detecting wafers;	 3-mm dia.	 1,000	1.7-mm dia. (0.08-mm dia.)	E32-T22S 	10 mm
	Side-view; suitable for detecting wafers;	 3.5 x 3 mm dia.	 700	2-mm dia. (0.04-mm dia.)	E32-T24S 	
Area sensing through-beam	Multi-point sensing (4-head)	 M3 screw	 300	2.0-mm dia. (0.04-mm dia.)	E32-M21	25 mm
	Stable for detecting minute sensing objects in a wide area; degree of protection: IEC60529 IP50	 11 mm	 600	(0.4-mm dia.)* ⁶	E32-T16P 	10 mm
	Suitable for detecting over a 10-mm area; long distance	 10 mm	 1,500 700	(2.0-mm dia.)* ⁶	E32-T16 	25 mm

- Note:**
- For common specifications of the Fiber Unit, refer to page 6.
 - The size of standard sensing object is the same as the fiber core diameter (lens diameter for models with lens).
 - The sensing distance of the minimum sensing object indicates the rated sensing distance unless otherwise specified.
- *1 Sensing distance indicates values for white paper.
*2 For continuous operation, use the products within the temperature ranging from -40°C to 130°C.
*3 Teflon is a registered trademark of the Dupont Company and the Mitsui Dupont Chemical Company for their fluoride resin.
*4 Indicates the heat-resistant temperature at the fiber tip. For further details, refer to page 26.
*5 Indicates values for the sensing distance of 100 mm.

Reflective Sensors

 Indicates models that allow free cutting. Models without this mark do not allow free cutting.











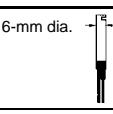

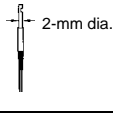

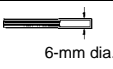



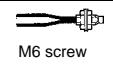



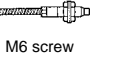

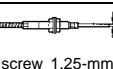

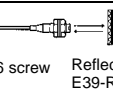

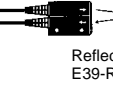





 : E3X-NH  : E3X-NHB

Application	Features	Appearance	Sensing distance (mm) *	Min. sensing object (Copper strand)	Model	Permissible bending radius
Long distance	M6	 M6 screw	 200  26	0.012-mm dia.	E32-D11L 	25 mm
	3 dia.; small diameter	 3-mm dia.	 120  16		E32-D12 	
	M4	 M4 screw	 50		E32-D21L 	
	3 dia.; small diameter	 3-mm dia.	 50		E32-D22L 	
General-purpose	M6	 M6 screw	 150  20	0.012-mm dia.	E32-DC200 	25 mm
	M3; small diameter	 M3 screw	 36		E32-DC200E 	
Thin fiber	2.5 dia.; with sleeve	 90 mm (40 mm) M6 screw 2.5 dia. (): E32-DC200B4	 150  20	0.012-mm dia.	E32-DC200B  E32-DC200B4 	25 mm
	1.2 dia.; with sleeve	 90 mm (40 mm) M3 screw 1.2 dia. (): E32-DC200F4	 36		E32-DC200F  E32-DC200F4 	
	Minute object sensing (0.8 mm dia.)	 3-mm dia. 0.8-mm dia.	 10		E32-D33 	
Flexible (R1)	Possible to bend like electric wires (R1);	 M6 screw	 90	0.02-mm dia.	E32-D11R 	1 mm
		 M3 screw	 14		E32-D21R 	
Flexible (resists breaking) (R4)	Ideal for mounting on moving sections (R4)	 M6 screw	 90  12	0.012-mm dia.	E32-D11 	4 mm
		 M3 screw	 14		E32-D21 	
Coaxial reflective	M6 Coaxial; positioning accuracy	 M6 screw	 150  20	0.012-mm dia.	E32-CC200 	25 mm
	3-dia. Coaxial; positioning accuracy	 3-mm dia.	 80  10		E32-D32L 	
	2-dia. Coaxial; high-precision positioning possible; possible to mount small-spot (0.5-mm dia) lens (E39-F3A)	 2-mm dia.	 40		E32-D32 	

- Note:**
- For common specifications of the Fiber Unit, refer to page 6.
 - The size of standard sensing object is the same as the fiber core diameter (lens diameter for models with lens).
 - The sensing distance of the minimum sensing object indicates the rated sensing distance unless otherwise specified. In case of the reflective Fiber Units, however, the sensing distance indicates the distance where the smallest object can be sensed.
- * Sensing distance indicates values for white paper.

 Indicates models that allow free cutting. Models without this mark do not allow free cutting.

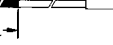
 : E3X-NH  : E3X-NHB

Application	Features	Appearance	Sensing distance (mm) *1	Min. sensing object	Model	Permissible bending radius		
Side-view reflective	6 dia.; long distance		 40	0.015-mm dia.	E32-D14L 	25 mm		
	2 dia.; small diameter space-saving		 15				0.012-mm dia.	E32-D24 
Heat-resisting reflective	Teflon-covered*3; withstands chemicals and harsh environments (operating ambient temperature: -30°C to 70°C)		 50  10	0.012-mm dia.	E32-D12F 	40 mm		
	Resists 150°C*2; fiber sheath material: fluoro resin (operating ambient temperature: -40°C to 150°C)		 120  12				E32-D51 	35 mm
	Resists 300°C*4; fiber sheath material: stainless steel (operating ambient temperature: -40°C to 300°C)		 45				E32-D61	25 mm
	Resists 400°C*4; fiber sheath material: stainless steel (operating ambient temperature: -40°C to 400°C)		 30				E32-D73	
Retroreflective	Transparent object detection		 10 to 250	0.3-mm dia.	E32-R21 +E39-R3 	25 mm		
	Transparent object detection (operating ambient temperature: -25°C to 55°C); degree of protection: IEC60529 IP66		 150 to 1,500	0.5-mm dia.	E32-R16 +E39-R1 			
Limited reflective	Detects wafers and small differences in height; (operating ambient temperature: -40°C to 105°C); degree of protection: IEC60529 IP50		 7.2±0.8	0.012-mm dia.	E32-L25L 	10 mm		
			 4±2				E32-L24L 	
	Detects wafers and small differences in height; degree of protection: IEC60529 IP50		 3.3		E32-L25 	25 mm		
			 3.3		E32-L25A 			
Fluid-level detection	Fluid contact type: unbendable section L 150 mm, 350 mm (two types)			Pure water at 25°C	E32-D82F1 E32-D82F2	40 mm		
	Tube-mounting type			Fluid	E32-L25T	10 mm		

- Note:**
- For common specifications of the Fiber Unit, refer to page 6.
 - The size of standard sensing object is the same as the fiber core diameter (lens diameter for models with lens).
 - The sensing distance of the minimum sensing object indicates the rated sensing distance unless otherwise specified. In case of the reflective Fiber Units, however, the sensing distance indicates the distance where the smallest object can be sensed.
- *1 Sensing distance indicates values for white paper.
*2 For continuous operation, use the products within the temperature ranging from -40°C to 130°C.
*3 Teflon is a registered trademark of the Dupont Company and the Mitsui Dupont Chemical Company for their fluoride resin.
*4 Indicates the heat-resistant temperature at the fiber tip. For further details, refer to page 26.

Specifications

Item	General-purpose models		Timer-function models		Mark-sens-ing models
	NPN	PNP	NPN	PNP	NPN
Output	NPN	PNP	NPN	PNP	NPN
Model	E3X-NH11	E3X-NH41	E3X-NH21	E3X-NH51	E3X-NHB11
Indicator	Operation indicator (orange LED), 8-level incident level indicator (green LED), 13-level threshold indicator (red LED)				
Ambient illumination	Incandescent lamp: 3,000 lx max.; Sunlight: 10,000 lx max.				
Ambient temperature	Operating: -25°C to 55°C (with no icing) Storage: -40°C to 70°C (with no icing)				
Ambient humidity	Operating: 35% to 85% (with no condensation)				
Insulation resistance	20 MΩ min. (at 500 VDC)				
Dielectric strength	1,000 VAC at 50/60 Hz for 1 minute				
Vibration resistance	10 to 55 Hz, 1.5-mm double amplitude or 300 m/s ² (approx. 30G) for 2 hrs each in X, Y, and Z directions				
Shock resistance	500 m/s ² (approx. 50G) for 3 times each in X, Y, and Z directions				
Degree of protection	IEC60529 IP50				
Connection method	Prewired (standard cord length: 2 m)				
Weight (packed state)	Approx. 100 g				
Material	Case: PBT; Cover: Polycarbonate				
Accessory	Mounting Brackets				

Fiber Sheath Materials

E32-T11R, -T21R, -T22S, -T24S, -D11R, -D21R	Copolymer vinyl chloride
E32-T11, -T21, -T16P, -D11, -D21	Vinyl chloride
E32-L25L, -L24L	Reinforced polyethylene
Other than the above	Black polyethylene

Specifications of Models Other than those in the Left Table

Operating ambient temperature	-40°C to 70°C
Operating ambient humidity	35% to 85% (with no icing)
Differential travel (Reflective models)	20% max. of sensing distance
Degree of protection	IEC 60529 IP67

Attachments

Name		Long Distance Lens Unit			
Applications		Increasing sensing distance			
Model		E39-F1			
Appearance		Through-beam (separate) 			
Applicable fibers		E32-T11L	E32-TC200 E32-T61	E32-T11R	E32-T11
With E3X-NH11/41	Sensing distance	2,000 mm	3,000 mm	2,100 mm	2,000 mm
	Standard object	Opaque objects: 4-mm dia. min.			
Directivity		5° to 40°			
Differential travel		---			
Ambient temperature		E32-T61: -40°C to 200°C (Do not exceed the operating temperature of the fiber.)			
Material	Shaft	Brass			
	Lens	Optical glass			
	Base	---			
	Reflector	---			

Name		Side-view Unit			
Applications		Changing the sensing direction at °90			
Model		E39-F2			
Appearance		Through-beam (separate) 			
Applicable fibers		E32-T11L	E32-TC200	E32-T11R	E32-T61/11
With E3X-NH11/41	Sensing distance	400 mm	500 mm	350 mm	400 mm
	Standard object	Opaque objects: 3-mm dia. min.			
Directivity		20° to 60°			
Differential travel		---			
Ambient temperature		E32-T61: -40°C to 200°C (Do not exceed the operating temperature of the fiber.)			
Material	Shaft	Brass			
	Lens	Optical glass			
	Base	---			
	Reflector	---			

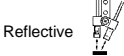
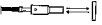
Name			Lens-equipped Reflective Unit				Small Spot Lens Unit
Applications			Converting through-beam sensors to reflective sensors				Detection over 0.5-mm-dia. spots
Model			E39-F3				E39-F3A
Appearance							Reflective 
Applicable fibers			E32-T11L	E32-TC200	E32-T61	E32-T11R	E32-T11
With E3X-NH11/41	Sensing distance (standard object)	White paper	10 to 300 mm* ¹ (20 x 20 cm)	35 to 180 mm* ¹ (20 x 20 cm)		25 to 120 mm (20 x 20 cm)	35 to 180 mm* ¹ (20 x 20 cm)
		Black paper	---	5 to 120 mm* ¹ (200 x 200 cm)	5 to 80 mm* ¹ (200 x 200 cm)	25 to 120 mm	5 to 70 mm* ¹ (200 x 200 cm)
Directivity			---				---
Differential travel			20% of sensing distance				20% of sensing distance
Ambient temperature			E32-T61: -40°C to 200°C (Do not exceed the operating temperature of the fiber.)				Operating: -40°C to 70°C
Material	Shaft	Brass					Aluminum
	Lens	Optical glass					Optical glass
	Base	Aluminum					---
	Reflector	---					---

*1These values are possible when the angle of the E39-F3 is smallest (parallel).

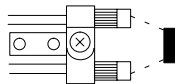

Name			Side-view Reflective Unit	
Applications			Converting through-beam to reflective sensor	
Model			E39-F5	
Appearance			Reflective 	
Applicable fibers			E32-TC200A	
With E3X-NH11/41	Sensing distance (standard object)	White paper	60 mm (10 x 10 cm)	
		Black paper	5 to 20 mm (10 x 10 cm)	
Directivity			---	
Differential travel			20% of sensing distance	
Ambient temperature			Operating: -40°C to 70°C	
Material	Shaft	---		
	Lens	---		
	Base	Brass		
	Reflector	Stainless		

Beam Spot Characteristics

E39-F3A with E32-D32

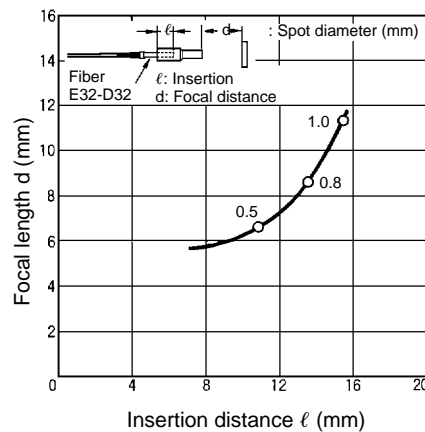

Spiral Tubes

Model	E39-F32A5	E39-F32A	E39-F32B5	E39-F32B	E39-F32C5	E39-F32C	E39-F32D5	E39-F32D
Appearance								
Length (L)	500 mm	1,000 mm	500 mm	1,000 mm	500 mm	1,000 mm	500 mm	1,000 mm
Head outer diameter (A)	6 dia.				7 dia.		8.5 dia.	
Head inner diameter (B)	M3 x 0.5, depth: 4				M4 x 0.7, depth: 4		M6 x 0.75, depth: 4	
Tube outer diameter (C)	4.6 dia.				5.6 dia.		7 dia.	
Applicable fiber	E32-DC200E E32-DC200F(4) E32-D21		E32-TC200E E32-TC200F(4) E32-T21 E32-T21L		E32-TC200 E32-TC200B(4) E32-T11 E32-T51 E32-T11L		E32-DC200 E32-DC200B(4) E32-CC200 E32-D11 E32-D51 E32-D11L	
Ambient temperature	Operating: -40°C to 150°C (Do not exceed the operating temperature of the fiber)							
Ambient humidity	Operating: 35% to 85%							
Permissible bending radius	30 mm min.							
Tensile strength	Between head connector and end cap with tube: 1.5 N • m (15 kgf • cm) Tube: 2 N • m (20 kgf • cm)							
Compression load	Tube: 29.4 N (3 kgf)							

Accessories

Name	Fiber Cutter	Fine-fiber Attachment	Fiber Connector	Sleeve Bender
Model	E39-F4	E39-F9	E39-F10	E39-F11
Appearance				
Features	Used to cut fibers to desired lengths	Used when inserting fine fibers into the amp	Used to connect additional fibers for extension	Used to bend fiber sleeves
Applicable fiber	All models equipped with fibers that can be trimmed.	E32-DC200E, -TC200E E32-DC200F(4), -TC200F(4) E32-D21, -D21L, -D22L E32-T21, -T21L, -T22L E32-D32, -T22 E32-D24, -T24 E32-D33 E32-R21, E32-D21R	E32-DC200, -TC200 E32-DC200B(4), -TC200B(4) E32-TC200A E32-T14, -G14 E32-D11L, -T11L, -T12L E32-D14L, -T14L E32-T17L	E32-TC200B(4) E32-DC200F(4), -TC200F(4) E32-DC9G(4)
	Provided with Fiber Units		Sold Separately	

Engineering Data

■ Excess Gain Ratio (Typical) With standard sensing object.

- E3X-NH 1

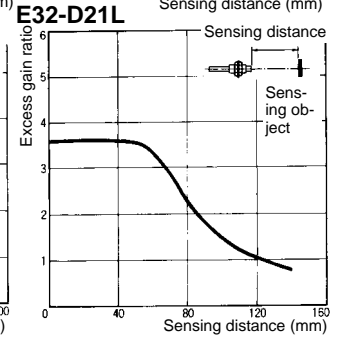
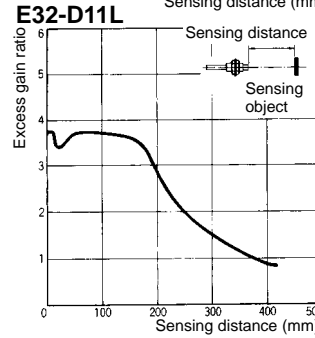
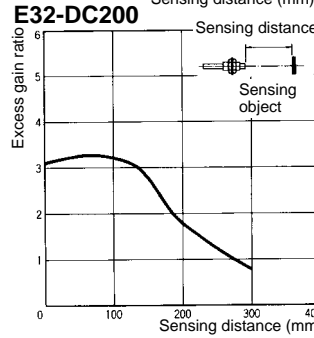
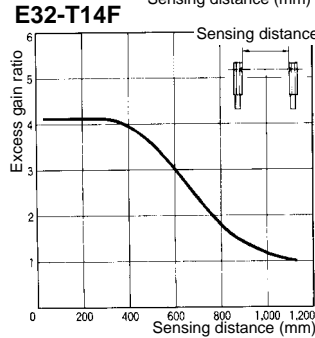
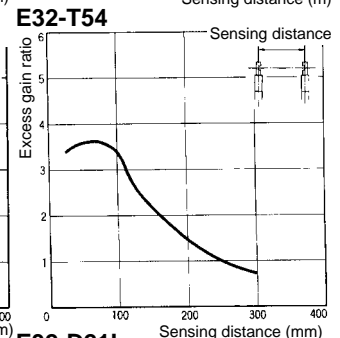
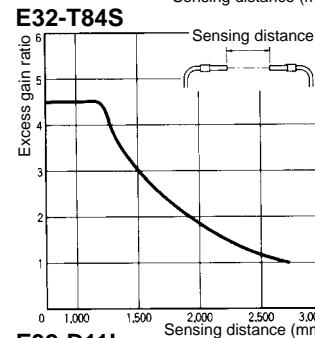
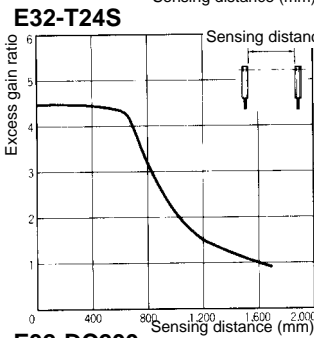
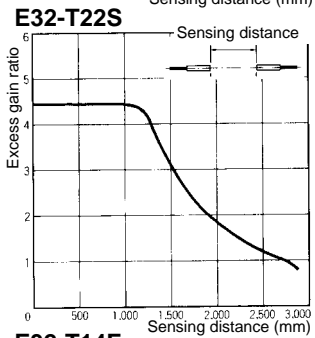
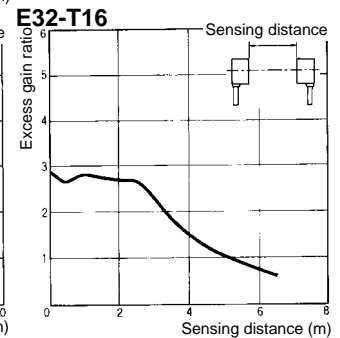
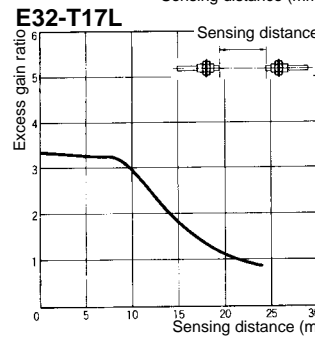
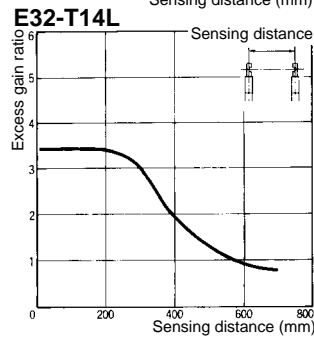
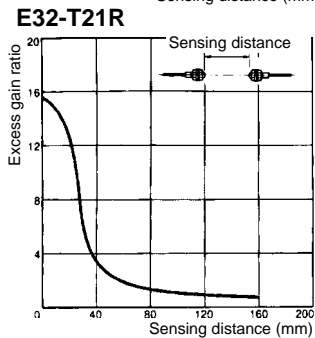
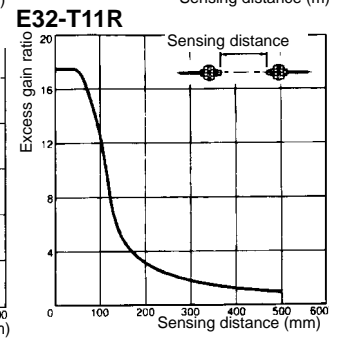
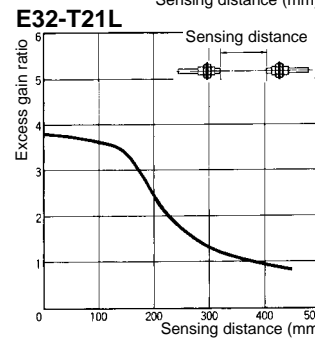
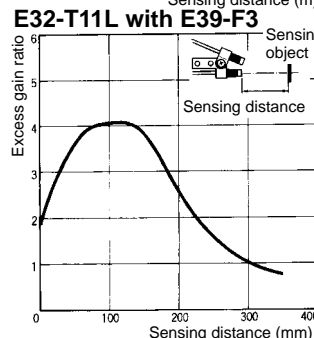
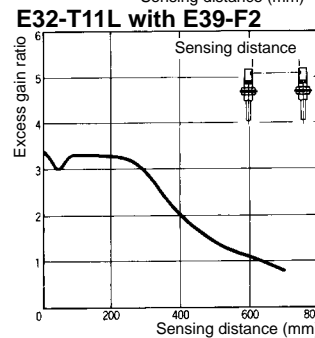
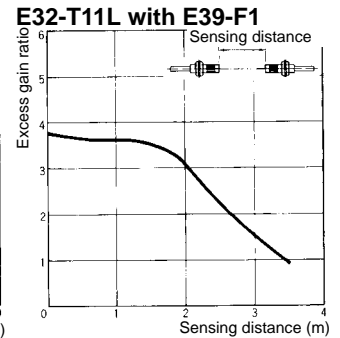
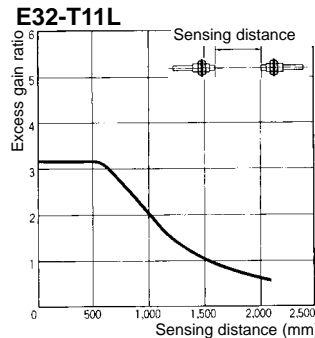
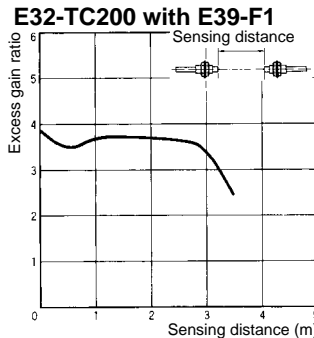
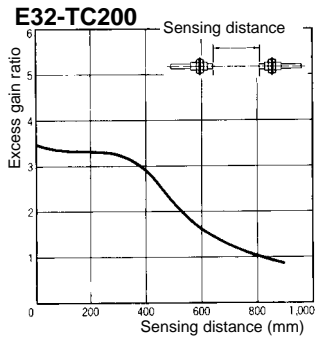

■ **Excess Gain Ratio (Typical)**

With standard sensing object

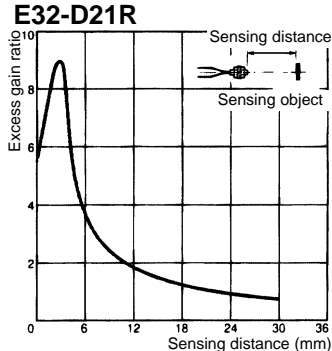
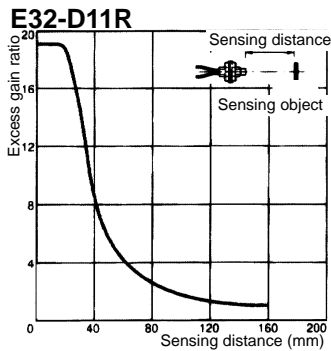

● **E3X-NHB11**

E32-TC200

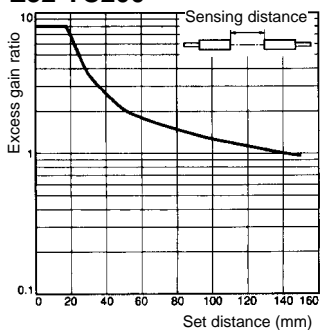

E32-TC200 + E39-F1

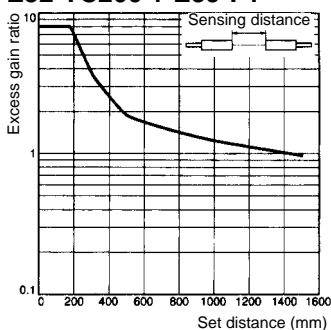

E32-D11

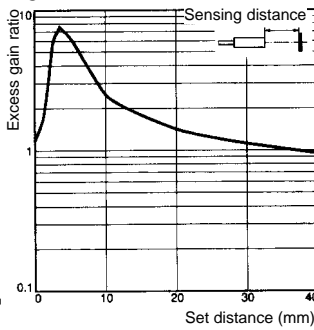

E32-D12

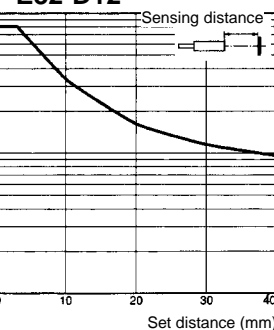

■ **Operating Range (Typical)**

With standard sensing object at max. sensitivity.

● **E3X-NH 1**

E32-T11L with E39-F3

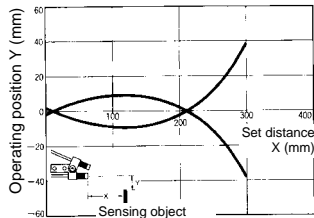

E32-DC200

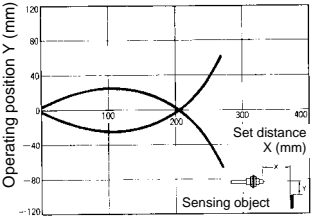

E32-D11L

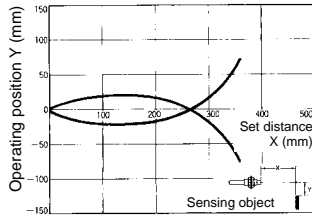

E32-D12

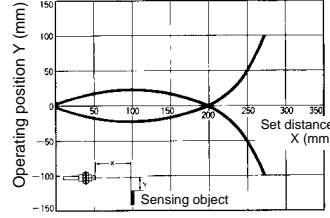

E32-D21L

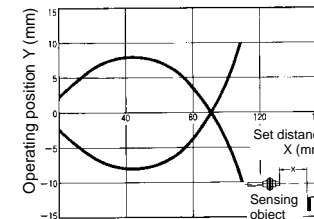

E32-DC200E

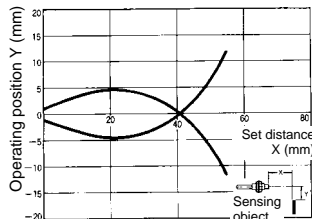

E32-D21

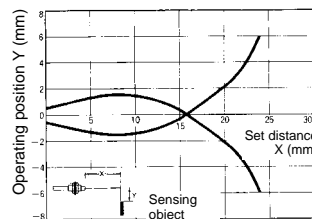

E32-D11R

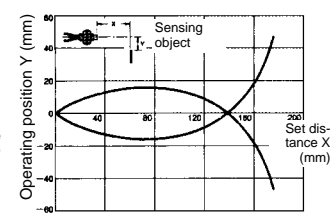

E32-D21R

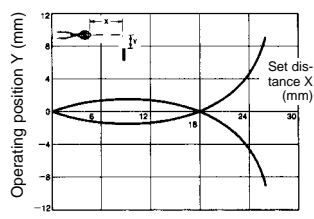

E32-D11

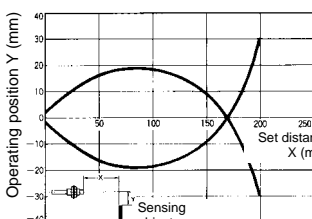

E32-CC200

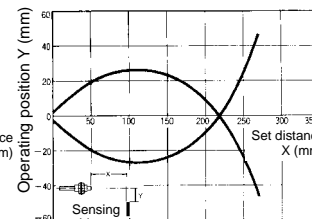

E32-D32

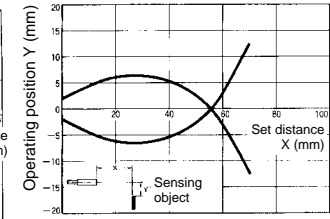

■ Operating Range (Typical)

With standard sensing object at max. sensitivity.

E32-D32L

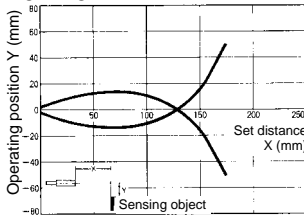

E32-D33

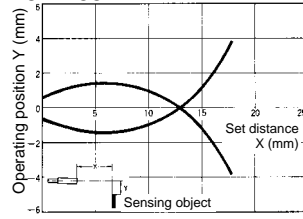

E32-D51

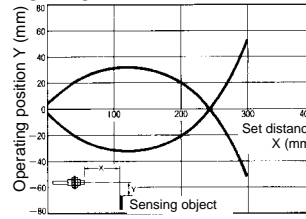

E32-L25L

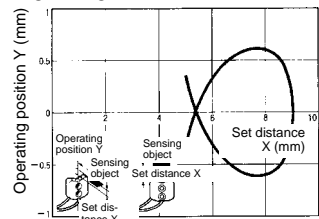

● E3X-NHB11

E32-DC200

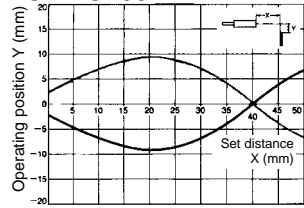

E32-D11L

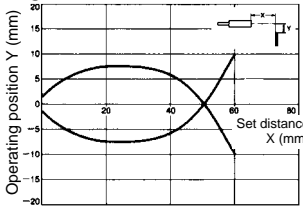

E32-CC200

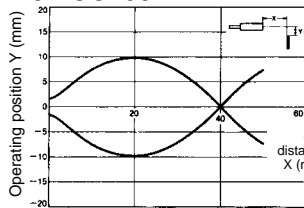

E32-D51

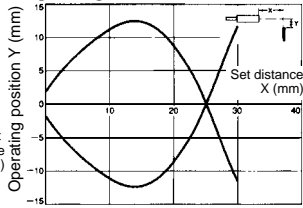

■ Parallel Operating Range (Typical)

At max. sensitivity.

● E3X-NH 1

E32-TC200

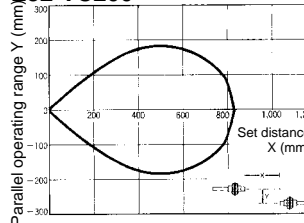

E32-TC200 with E39-F2

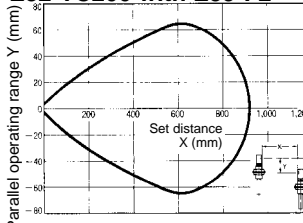

E32-T11L

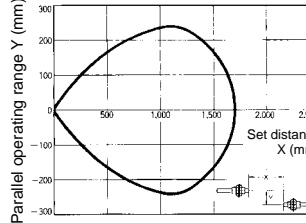

E32-T11L with E39-F1

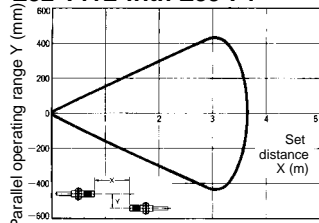

E32-T11L with E39-F2

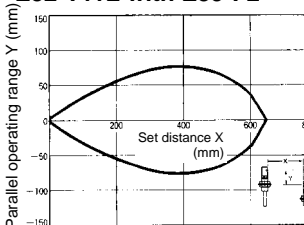

E32-T21L

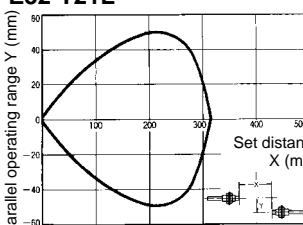

E32-T22

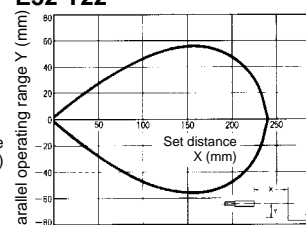

E32-T11R

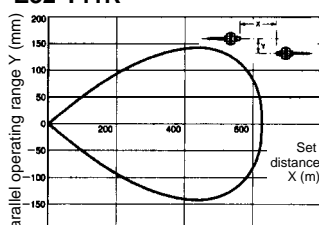

■ Parallel Operating Range (Typical)

At max. sensitivity.

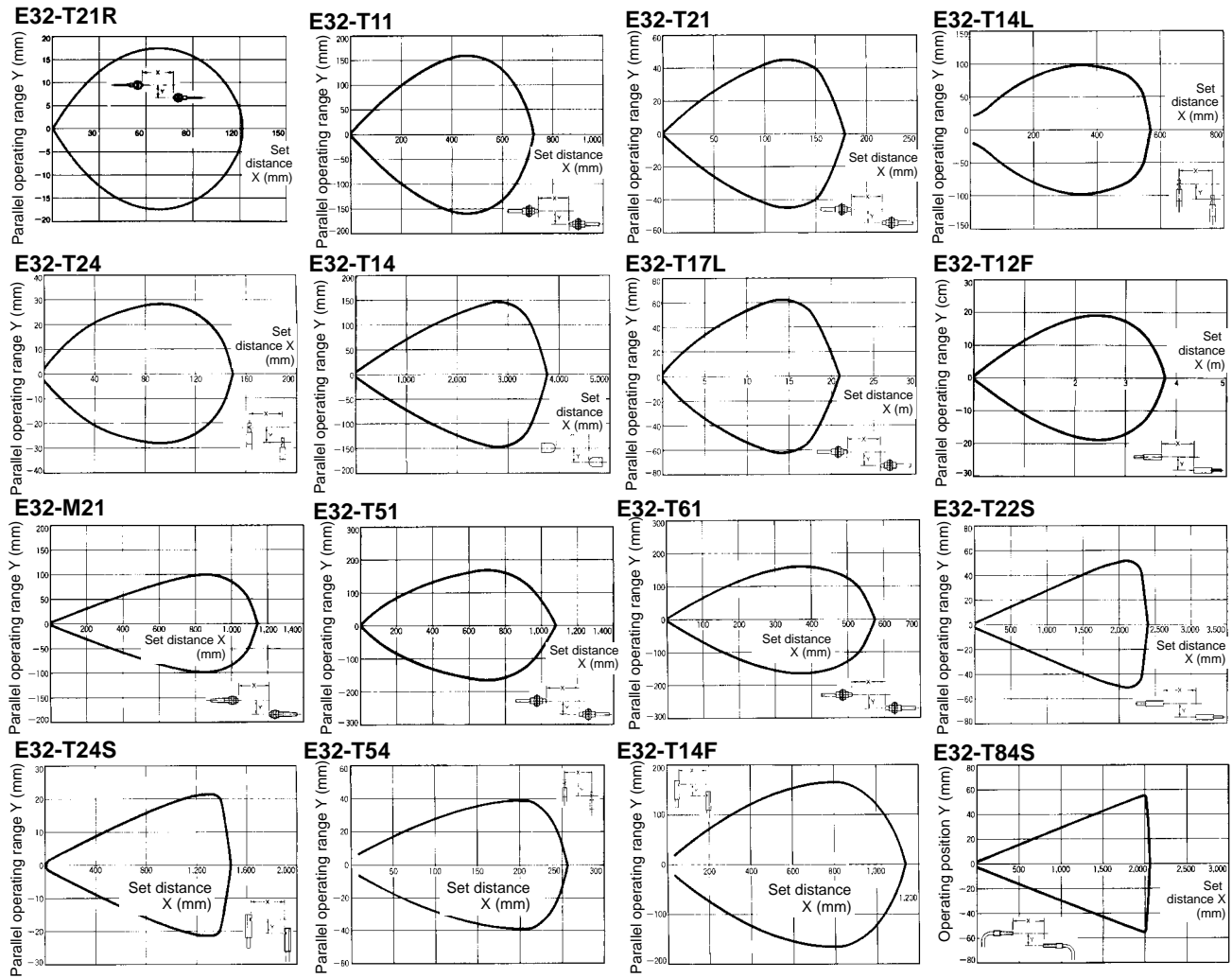

● E3X-NHB11

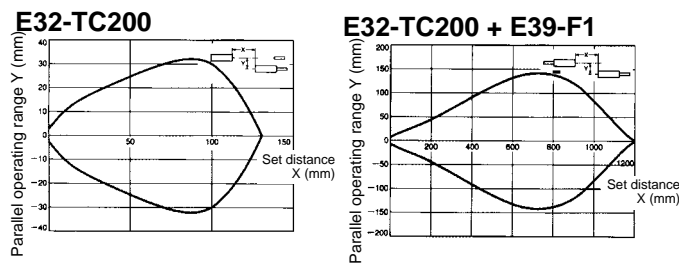

Nomenclature

- E3X-NH11 (NPN) E3X-NH41 (PNP)
- E3X-NH21 (NPN) E3X-NH51 (PNP)
- E3X-NHB11 (NPN)

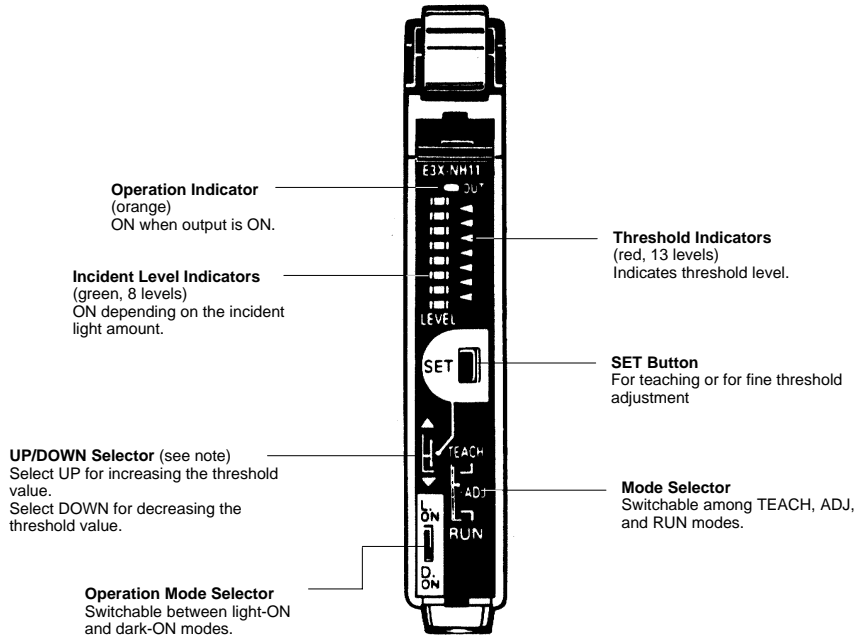

Operation

Output Circuits

Output	Model	Mode selector	State of output transistor	Output circuit	Timing chart
NPN	E3X-NH11 E3X-NHB11	LIGHT ON (L/ON)	Light ON		Light received Light not received Operation indicator (orange) ON OFF Output transistor ON OFF Load (relay) Operate Release (Between brown and black)
		DARK ON (D/ON)	Dark ON		Light received Light not received Operation indicator (orange) ON OFF Output transistor ON OFF Load (relay) Operate Release (Between brown and black)
	E3X-NH21	LIGHT ON (L/ON)	Light ON		Light received Light not received Operation indicator (orange) ON OFF Output transistor ON OFF Load (relay) Operate Release T: OFF-delay timer set to 40 ms
		DARK ON (D/ON)	Dark ON		Light received Light not received Operation indicator (orange) ON OFF Output transistor ON OFF Load (relay) Operate Release T: OFF-delay timer set to 40 ms
PNP	E3X-NH41	LIGHT ON (L/ON)	Light ON		Light received Light not received Operation indicator (orange) ON OFF Output transistor ON OFF Load (relay) Operate Release (Between blue and black)
		DARK ON (D/ON)	Dark ON		Light received Light not received Operation indicator (orange) ON OFF Output transistor ON OFF Load (relay) Operate Release (Between blue and black)
	E3X-NH51	LIGHT ON (L/ON)	Light ON		Light received Light not received Operation indicator (orange) ON OFF Output transistor ON OFF Load (relay) Operate Release T: OFF-delay timer set to 40 ms
		DARK ON (D/ON)	Dark ON		Light received Light not received Operation indicator (orange) ON OFF Output transistor ON OFF Load (relay) Operate Release T: OFF-delay timer set to 40 ms

■ Sensitivity Setting and Adjustment

Refer to the following to select the most suitable sensitivity setting method. It is recommended that with/without-object teaching and manual-tuning be tried first.

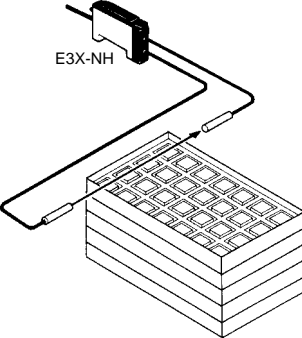
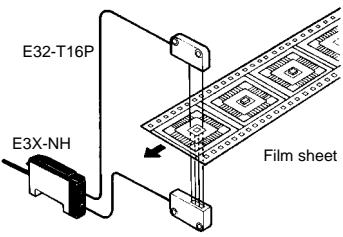
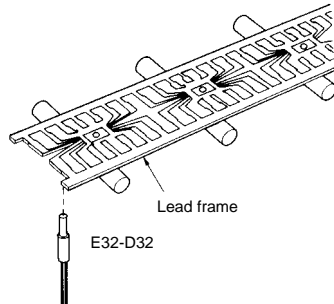
Sensitivity Setting	<p>Using the Sensor at the Maximum Sensitivity</p> <p>Application Examples Detection of passing objects with through-beam sensor. Detection of the existence of objects that interrupt light perfectly. Detection of objects with no background objects.</p> <p>Checking IC Tray Arrangements</p> 	<p>Sensing Slight Differences</p> <p>Application Examples Detection of slight differences in reflection. Detection of translucent objects. Detection of object surface irregularities. Color discrimination.</p> <p>Detecting IC Chips on Film Sheet</p> 	<p>Sensitivity Setting Without Objects</p> <p>Application Examples Detection of minute passing objects. Detection of lead wires. High-precision positioning.</p> <p>Detecting Lead Frame Position</p> 
	1. Maximum Sensitivity Setting	2. With/Without-object Teaching	3. Positioning/No-object Teaching

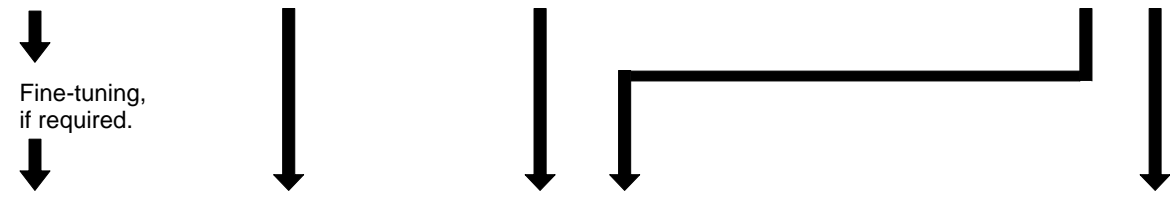

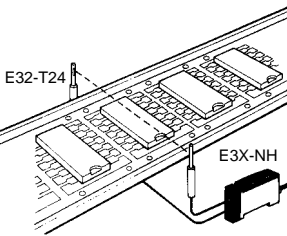
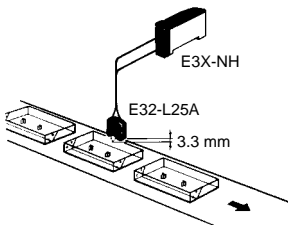
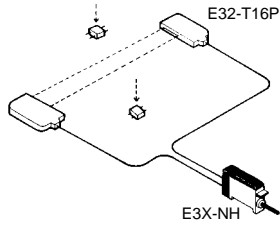
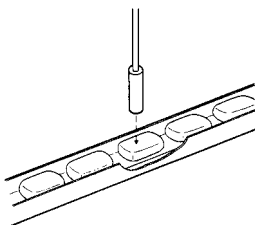
Sensitivity Adjustment (Fine-tuning)	<p>Fine-tuning on Production Lines</p> <p>Occasion Marginal sensitivity adjustment is required considering the differences of objects. High-precision positioning of electronic parts is required.</p> <p>Detecting Lead Frame Rises</p>  <p>Detecting Cassette Tape Cases</p> <p>Ensuring reliable detection without being influenced by the difference in color or mark.</p> 	<p>Ideal Operation Under Frequently Changing Environments</p> <p>Occasion Dust sticking to the fiber head. Sensing objects are slightly different to one another in color or surface conditions.</p> <p>Detecting Passing Chip Parts</p>  <p>Counting Number Of Pills</p> 
	A. Manual-tuning (Fine Sensitivity Adjustment)	B. Auto-tuning (Automatic Sensitivity Compensation)

■ Sensitivity Setting (Teaching)

Note: The sensitivity of the E3X-NH/NHB is factory-set to maximum. When resetting the sensitivity of the E3X-NH to maximum after with/without-object teaching, follow the steps described below.

1. Maximum Sensitivity Setting

1. Set the mode selector to TEACH.
Press the SET button for three seconds minimum. Be sure that all the threshold indicators (red) are ON. The built-in buzzer beeps once when the threshold indicators are ON.

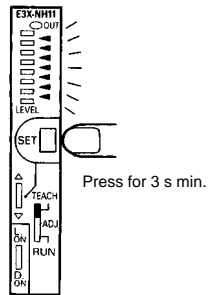

2. The sensitivity will be set when the built-in buzzer beeps continuously and all the incident level indicators (green) are ON.

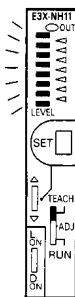

3. Set the mode selector to RUN. Be sure that only the bottom threshold indicator is ON.

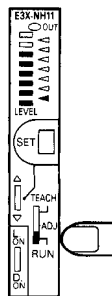

2. With/Without-object Teaching

1. Set the mode selector to TEACH.
Locate the sensing object in the sensing area and press the SET button once. Be sure that all the threshold indicators (red) are ON. The built-in buzzer beeps once when the threshold indicators are ON.

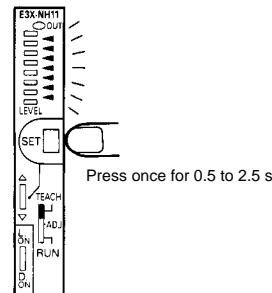

Through-beam Model

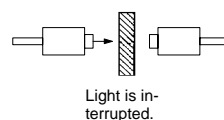

Reflective Model

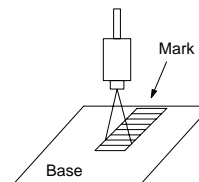

Reflective Model

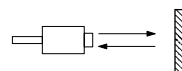

2. Move the object and press the SET button.

If teaching is OK:

All the incident level indicators (green) are ON. The built-in buzzer beeps once.

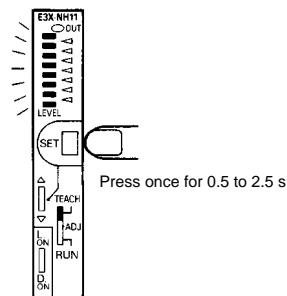

If teaching is NG:

The threshold indicator (red) flashes. The built-in buzzer beeps 3 times. Change the position of the object and the sensing distance that have been set and repeat from the beginning.

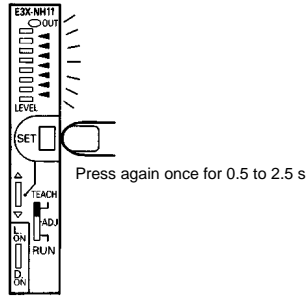

3. Positioning/No-object Teaching

1. Set the mode selector to TEACH. Press the SET button once without a sensing object in the sensing area. Be sure that all the threshold indicators (red) are ON. The built-in buzzer beeps once when the threshold indicators are ON.

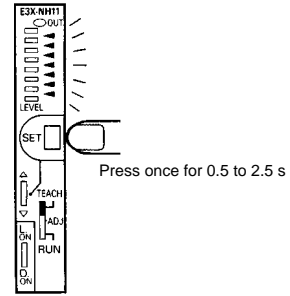

Through-beam Model

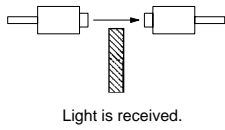

Reflective Model

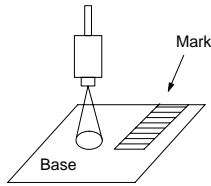

Reflective Model

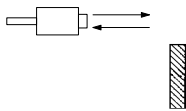

2. Set the mode selector to RUN. The threshold is set automatically.

Use the manual tuning function for making fine adjustments.

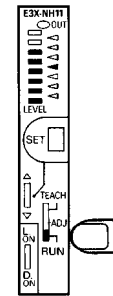

3. Set the mode selector to RUN. Be sure that the middle threshold indicator is ON, which means the threshold will be set to the middle between the values obtained with and without the sensing object.

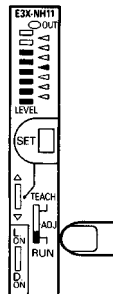

■ Sensitivity Adjustment (Tuning)

A. Manual-tuning (Fine Sensitivity Adjustment)

Note: The auto-tuning function will be disabled if manual-tuning is executed.

1. After setting the sensitivity of the E3X-NH, select the adjustment direction with the UP/DOWN selector in the ADJ mode.

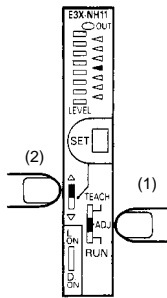

2. Press the SET button in ADJ mode. Be sure that the threshold changes whenever the SET button is pressed. If two threshold indicators are ON, the threshold will be set to the middle value between the values corresponding to these indicators.

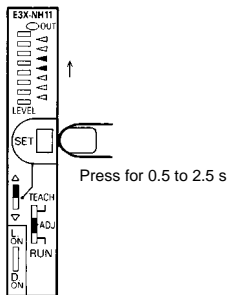

3. Set the mode selector to RUN.

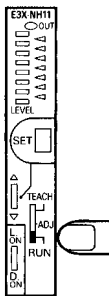

B. Auto-tuning (Automatic Sensitivity Compensation)

1. Set the mode selector to TEACH.
Press the SET button once without a sensing object in the sensing area. Be sure that all the threshold indicators (red) are ON. The built-in buzzer beeps once when the threshold indicators are ON.

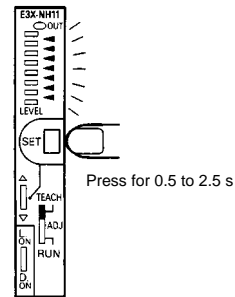

2. Set the mode selector to ADJ and press the SET button for three seconds minimum. Be sure that the threshold indicator (red) flashes. The built-in buzzer beeps continuously.

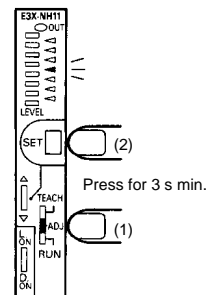

3. Set the mode selector to RUN. The threshold indicator (red) will continue to flash while the the auto-tuning function is enabled.

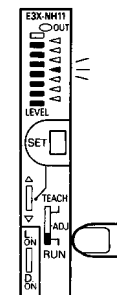

■ Threshold Setting and Indicators at Sensitivity Setting

Threshold indicators													
Level	1	2	3	4	5	6	7	8	9	10	11	12	13

Maximum Sensitivity Setting

- Use the Through-beam Sensor for detection of opaque objects.
- Use the Reflective Sensor for detection of objects with no background objects.

The threshold will be set to a level slightly higher than the no-light received by the E3X-NH if the sensitivity is set to maximum for the detection of objects that completely interrupt light or the incident of the Sensor is very low.

Reflective Sensor

The number of lit indicators of the incident level indicators will depend on the incident. The bottom indicator of the threshold indicators is ON.

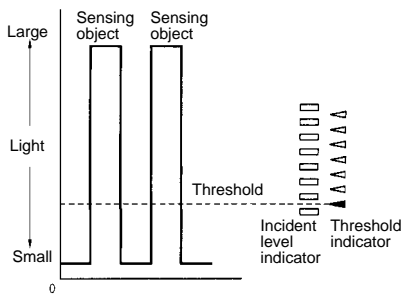

With/Without-object Teaching

- Ideal for the detection of object surface irregularities or minute objects.
- Ideal for the detection of objects with background objects reflecting light irregularly.

1. With/Without-object Teaching

Reflective Sensor:

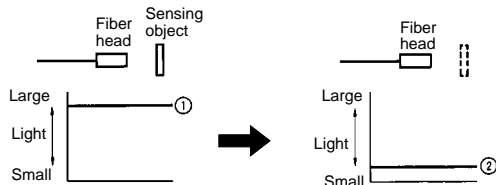

Press the SET button with the sensing object in the sensing area.

Press the SET button without sensing object in the sensing area.

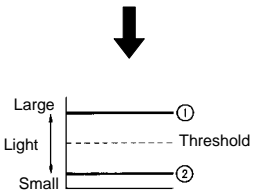

Set the threshold to the middle value between the values obtained with and without the sensing object.

2. RUN/ADJ Mode

Reflective Sensor:

The number of lit indicators of the incident level indicators depends on the incident. At the time of manual-tuning, it is possible to adjust the threshold in six levels. The default threshold is set to 7.

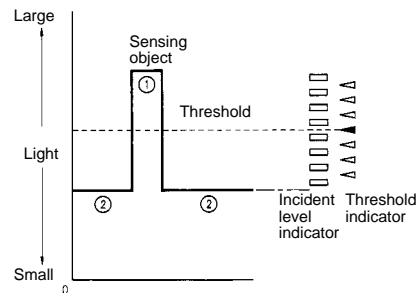

Positioning/No-object Teaching

- Ideal if it is impossible to perform teaching with the sensing object stationary in the sensing area.
- Ideal for high-precision positioning.
- Ideal for teaching with only background objects for the detection of bright or dark objects.

Reflective (Light-ON) Fiber Unit

1. Press the SET button without sensing object in the sensing area.

Tentatively set the threshold to the value that is $\pm 6\%$ of the incident level.

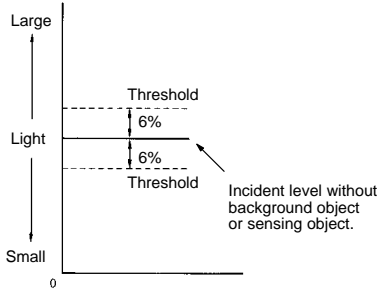

Note: If the incident is low at the time of teaching and the threshold cannot be set to the position corresponding to -6% of the incident level, the sensitivity will be set to maximum automatically when the E3X-NH is in RUN mode.

2. Detecting the first object in RUN/ADJ mode.

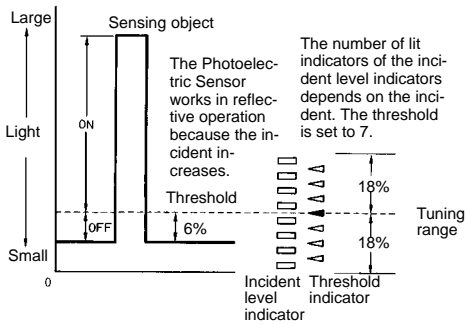

Through-beam (Dark-ON) Fiber Unit

1. Press the SET button without sensing object in the sensing area.

Tentatively set the threshold to the value that is $\pm 6\%$ of the incident level.

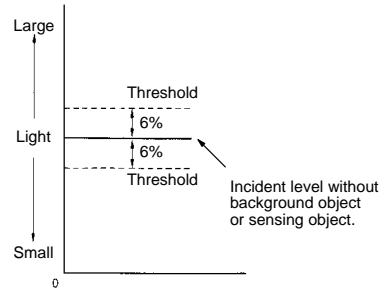

Note: If the incident is low at the time of teaching and the threshold cannot be set to the position corresponding to -6% of the incident level, the sensitivity will be set to maximum automatically when the E3X-NH is in RUN mode.

2. Detecting the first object in RUN/ADJ mode.

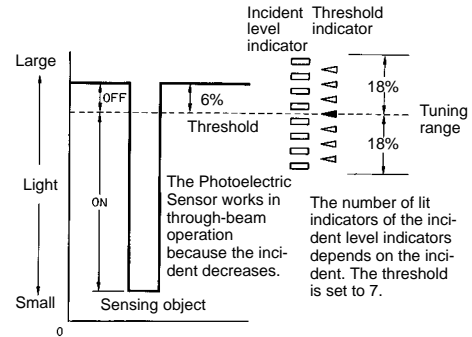

Threshold vs. Indicators after Auto-tuning Setting

1. Set the initial threshold by performing positioning/no-object teaching in TEACH mode.
2. Press the SET button for three seconds minimum in ADJ mode.

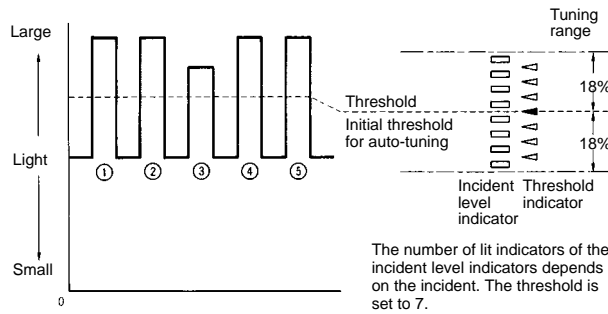

Taking into consideration the vibration of the sensing objects on the in-line operation, sample the incident with the first five sensing objects after setting the threshold and set the threshold again to the middle value between the highest and lowest incident values obtained with the sensing objects. The E3X-NH will then perform auto-tuning within a range of $\pm 18\%$ of this value.

3. With sensing objects passing.

The threshold is automatically compensated within the tuning area that has been preset. When the threshold is automatically compensated, the threshold indicator will be flash according to the adjusted value.

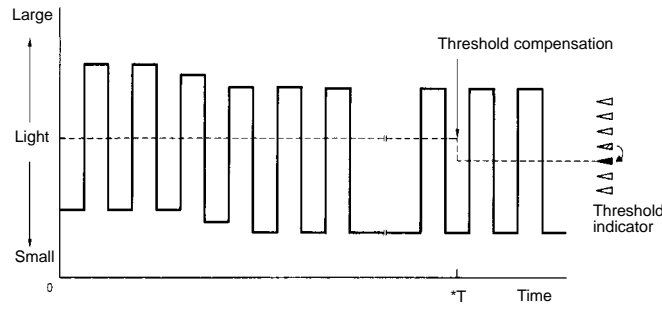

*T The threshold is compensated 1, 3, 6, 10, 15, 22, and 30 minutes after the E3X-NH/NHB is turned on. After that, the threshold is compensated every 30-minute period.

- Note:**
1. The alarm signal is output if the threshold compensation range is not within the tuning range.
 2. Perform sensitivity setting again if the alarm signal is output.

Dimensions

Note: All units are in millimeters unless otherwise indicated.

■ Amplifier

E3X-NH 1
E3X-NHB11

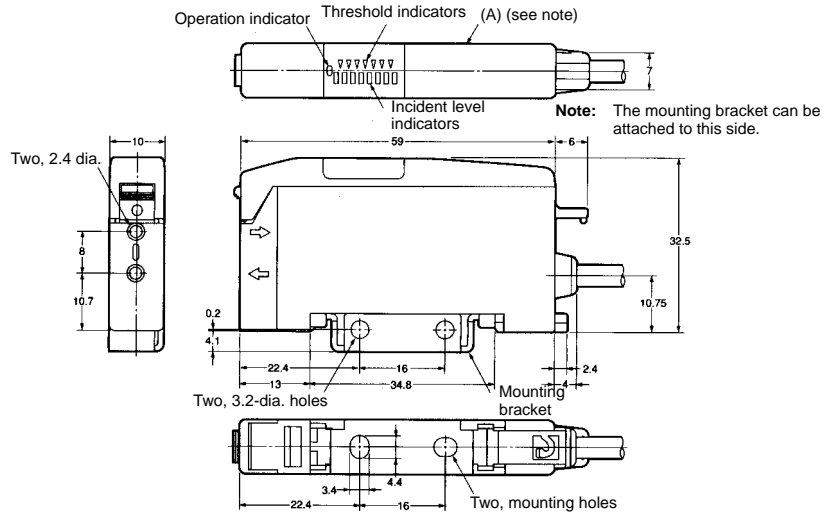
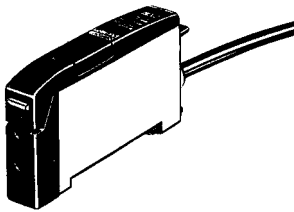

Cord: Polyvinyl chloride-covered cord
4-mm dia. (18/0.12 dia), 4 cores
Standard length: 2 m

Weight: Approx. 100 g

Fiber Units

Through-beam (Sold in Pairs)

 Indicates models that allow free cutting. Models without this mark do not allow free cutting.

E32-T11L 

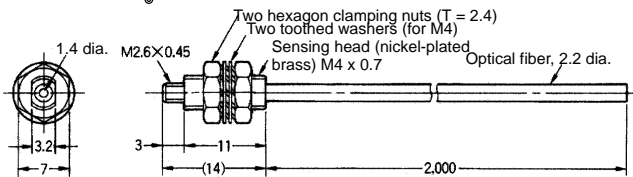

E32-T12L 

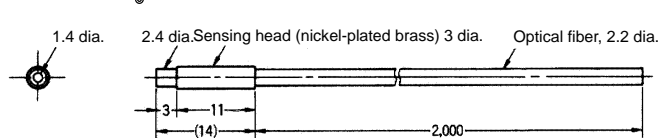

E32-T21L 

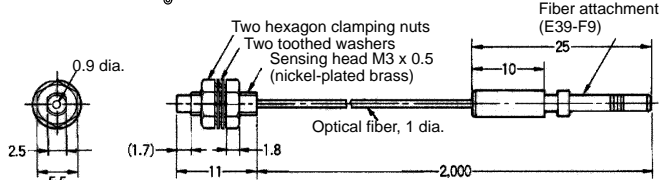

E32-T22L 

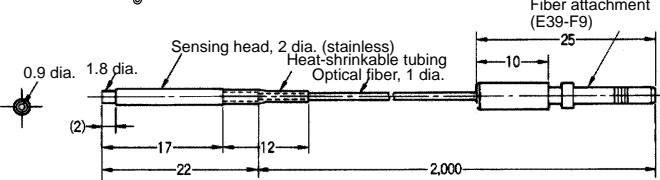

E32-TC200 

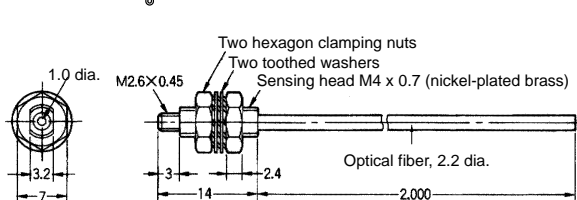

E32-TC200B
E32-TC200B4 

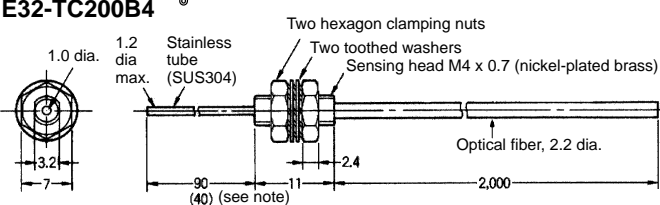

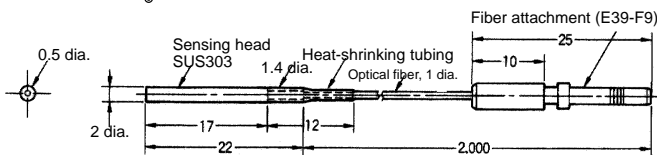

Note: The value in the parentheses is for the E32-TC200B4.

E32-T22 

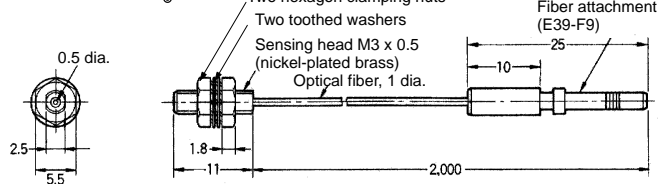

E32-TC200E 



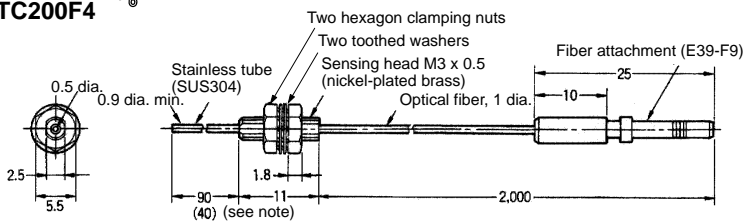

E32-TC200F
E32-TC200F4 

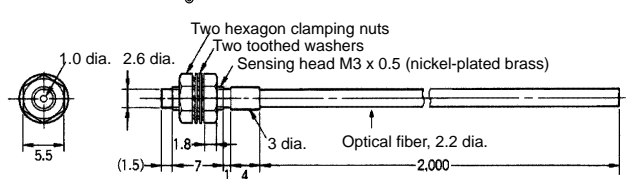

Note: The value in the parentheses is for the E32-TC200F4.

E32-TC200A 



E32-T11R 

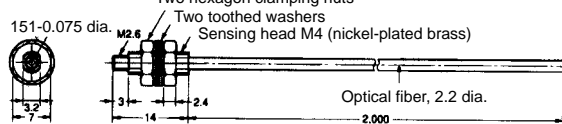

E32-T21R

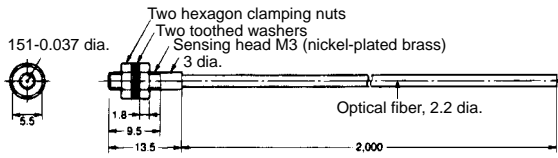

E32-T11

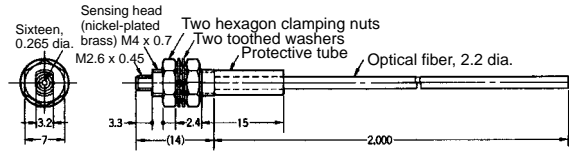

E32-T21

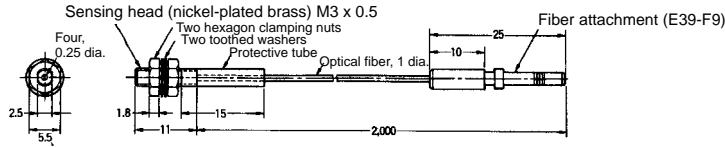

E32-T14L

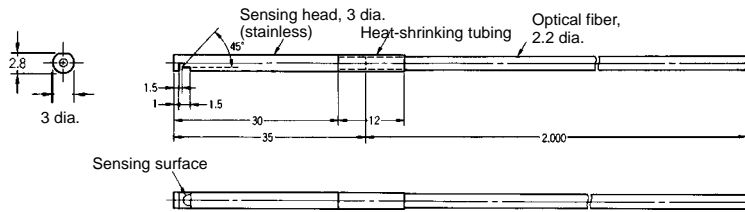

E32-T24

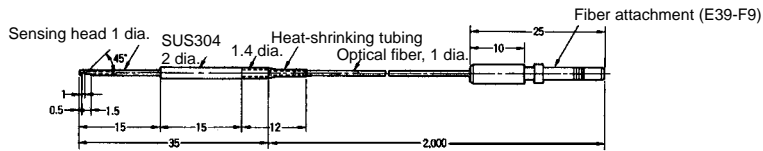

E32-T14

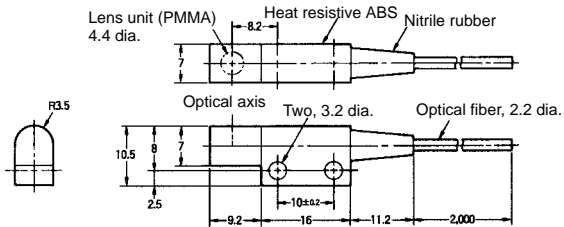

E32-T17L

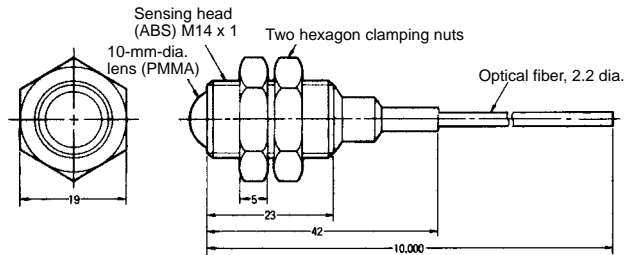

E32-T12F

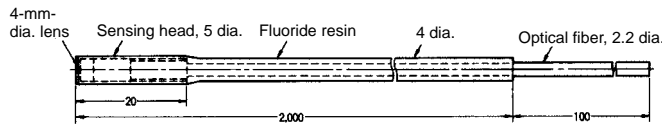

E32-T14F

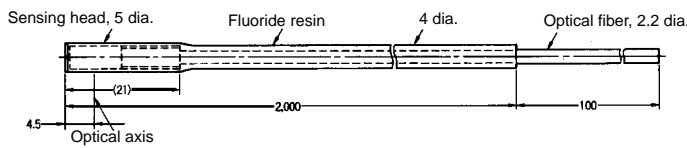

E32-T16

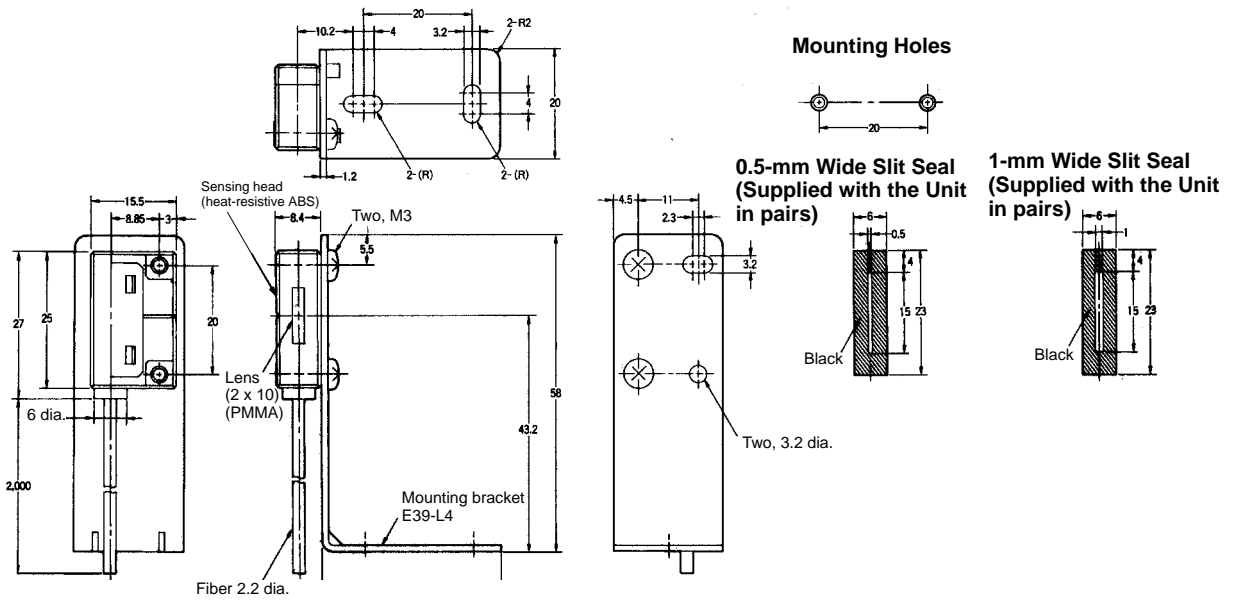

E32-T16P

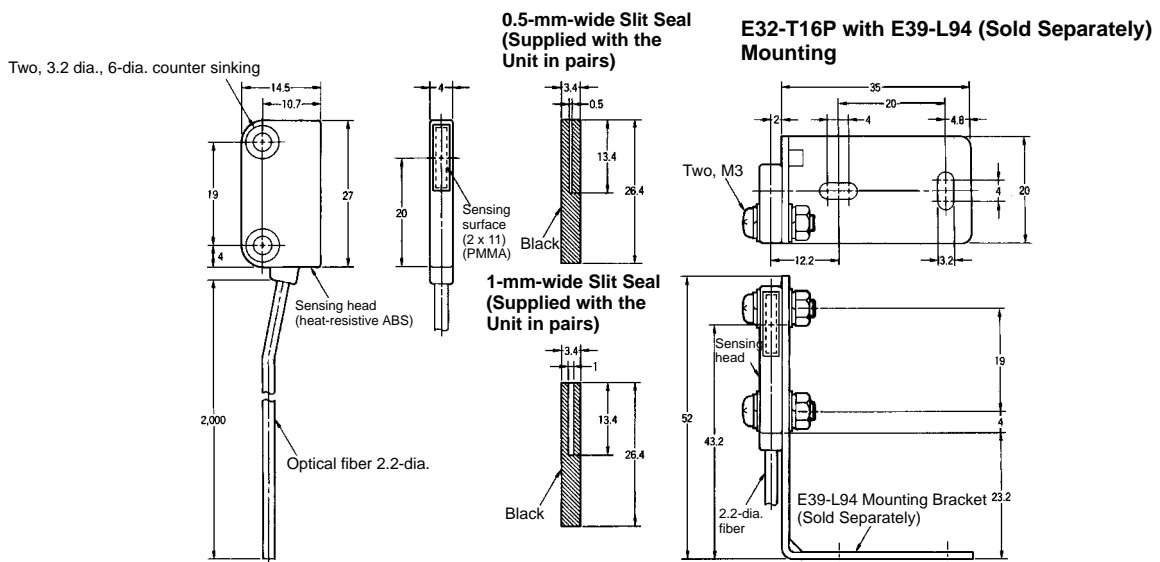

E32-M21

Note: One set of silicone tubes is black while the other set is grey for easy identification when they are connected to the emitter and receiver.

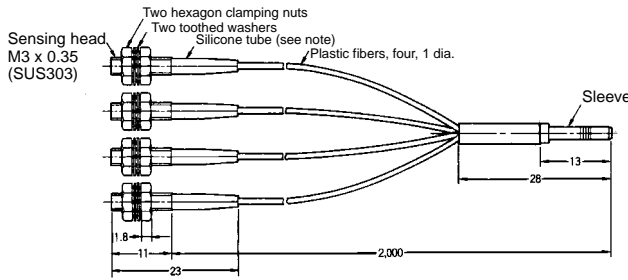

E32-T51

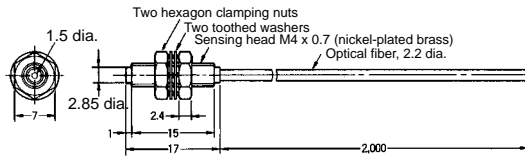

Note: Resistant temperature is 150°C.
Resistant temperature is 130°C when used continuously.

E32-T54

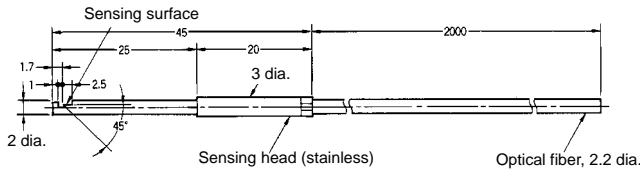

Note: Resistant temperature is 150°C.
Resistant temperature is 130°C when used continuously.

E32-T61

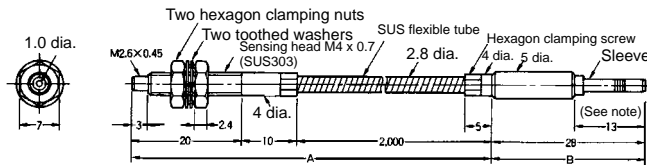

Note: Section A resists 300°C and section B (which is inserted to the Amplifier) resists 110°C.
The operating temperature of the section to be inserted (marked with *) must be within the operating temperature range of the Amplifier.

E32-T84S

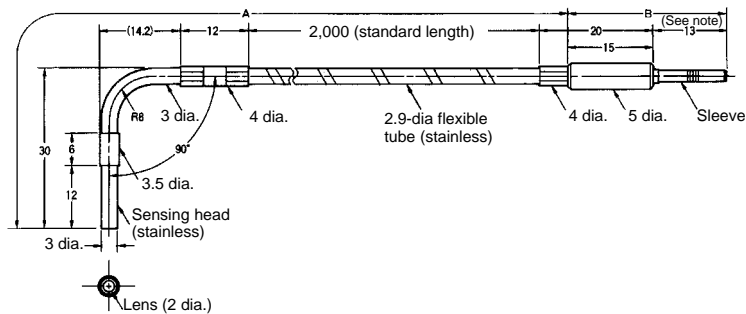



Note: Section A resists 200°C and section B (which is inserted to the Amplifier) resists 110°C.
The operating temperature of the section to be inserted (marked with *) must be within the operating temperature range of the Amplifier.

Reflective

 Indicates models that allow free cutting. Models without this mark do not allow free cutting.

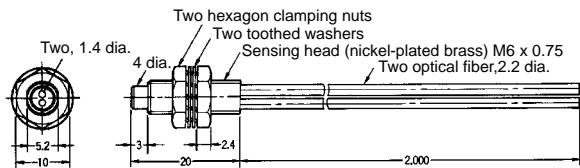
E32-D11L 



E32-D12 

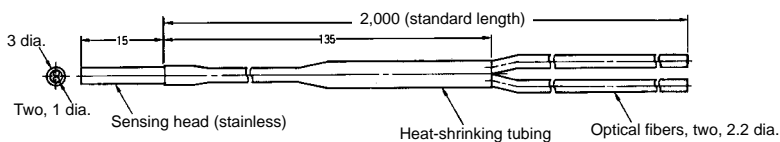

E32-D21L 

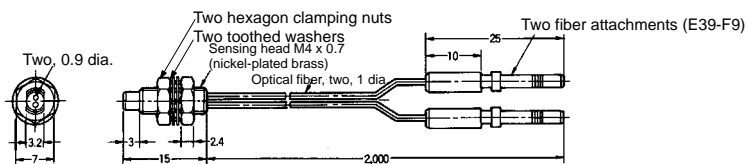

E32-D22L 

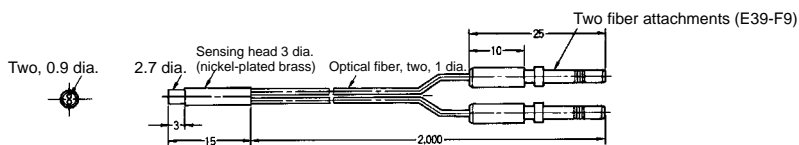

E32-DC200 

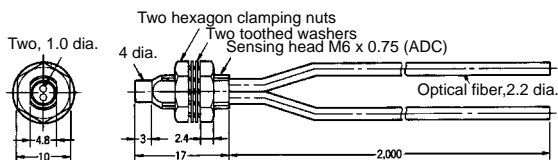

E32-DC200B
E32-DC200B4 

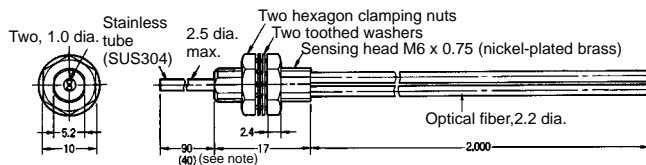

Note: The value in the parentheses is for the E32-DC200B4.

E32-DC200E 

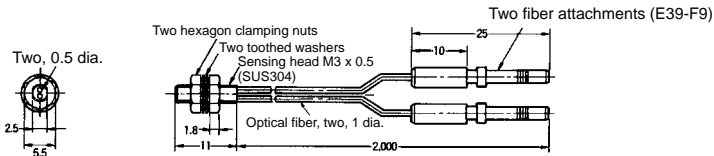

E32-DC200F
E32-DC200F4

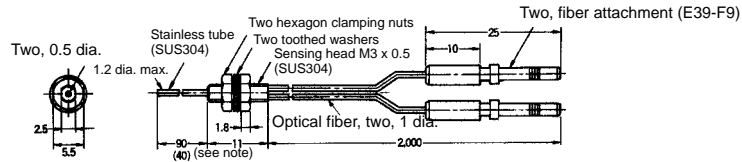

Note: The value in the parentheses is for the E32-DC200F4.

E32-D11R

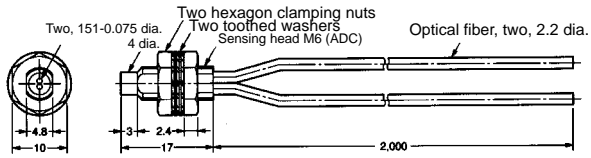

E32-D21R

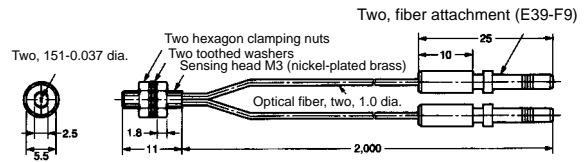

E32-D11

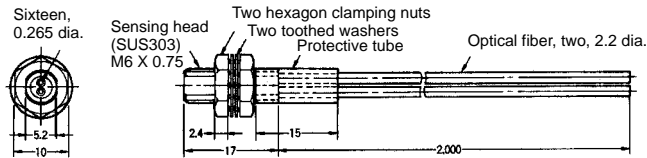

E32-D21

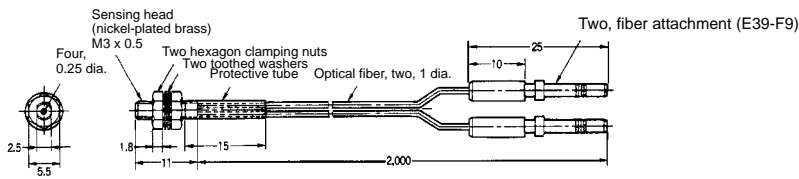

E32-D33

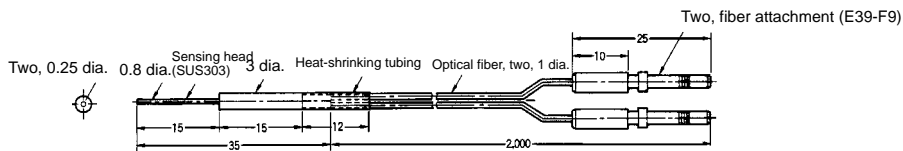

E32-CC200

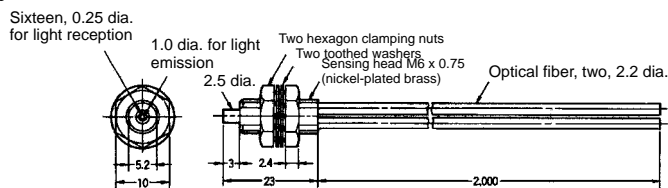

Note: The fiber for the emitter is identified by a white line.

E32-D32

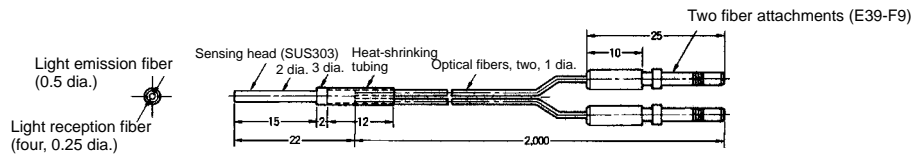

Note: The fiber for the emitter is identified by a white line.

E32-D32L ✂

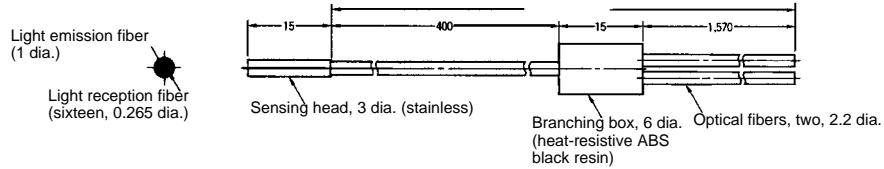

Note: The fiber for the emitter is identified by a yellow dotted line.

E32-D14L ✂

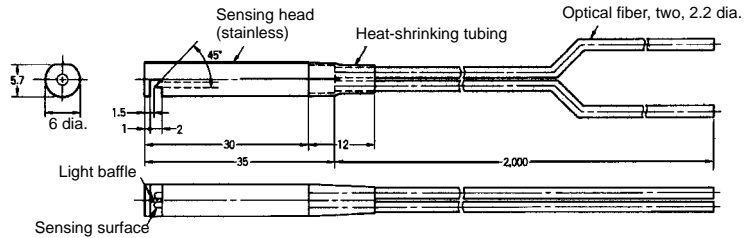

E32-D24 ✂

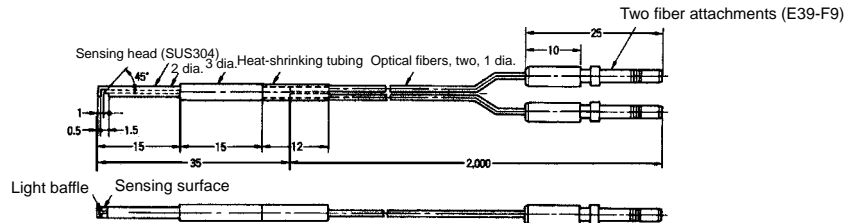

E32-D12F ✂

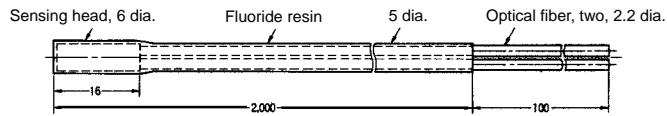

E32-D51 ✂

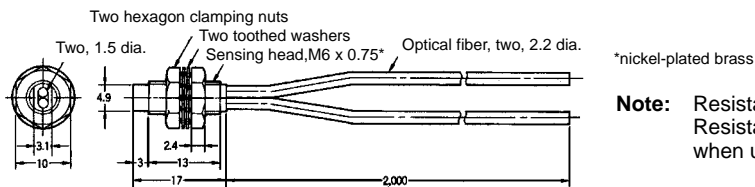

Note: Resistant temperature is 150°C.
Resistant temperature is 130°C when used continuously.

E32-D61

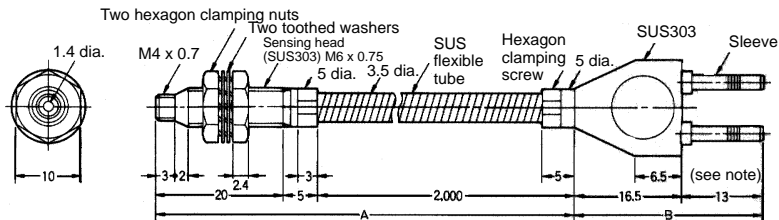

Note: Section A resists 300°C and section B (which is inserted to the Amplifier) resists 110°C. The operating temperature of the section to be inserted (marked with *) must be within the operating temperature range of the Amplifier.

E32-D73

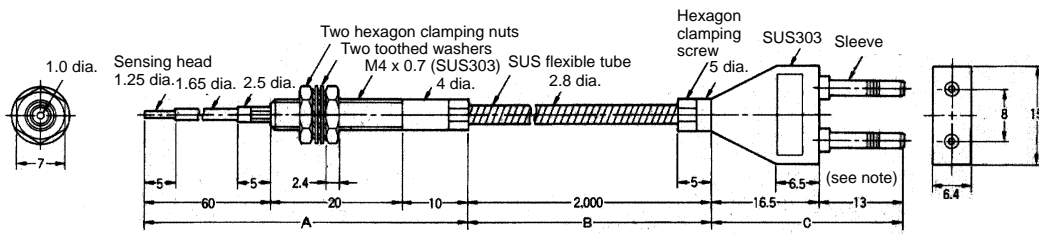

Note: Section A resists 400°C, section B resists 300°C, and section C (which is inserted to the Amplifier) resists 110°C. The operating temperature of the section to be inserted (marked with *) must be within the operating temperature range of the Amplifier.

E32-R21
 (One E39-R3 Reflector is supplied with the Sensor.)

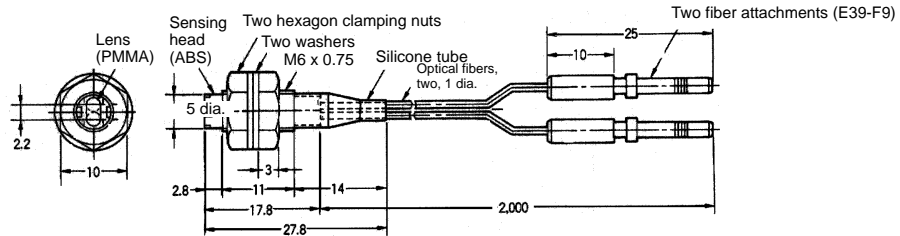

E32-R16
 (One E39-R1 Reflector is supplied with the Sensor.)

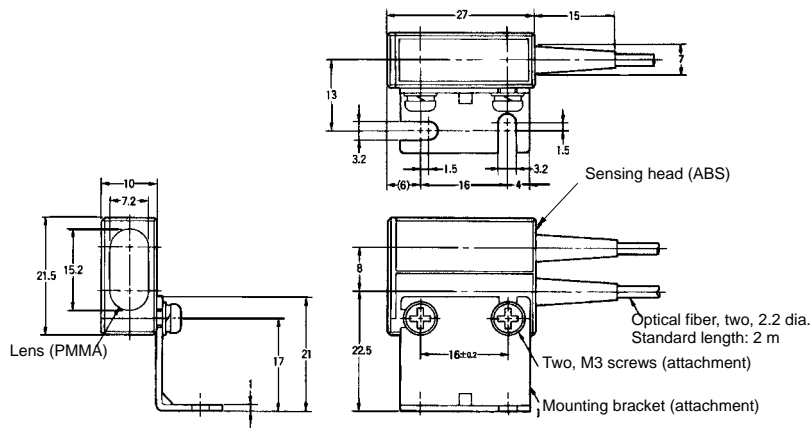

E32-L25

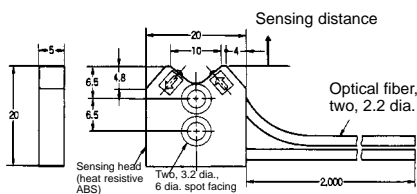

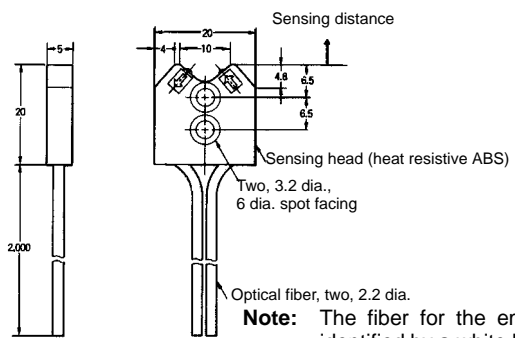

E32-L25A

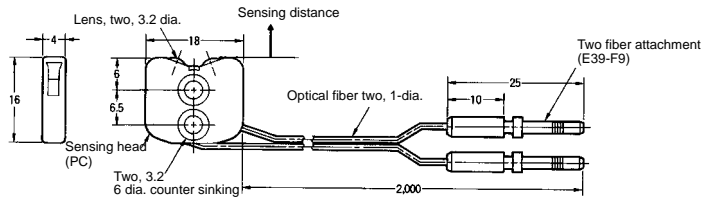

Note: The fiber for the emitter is identified by a white line.

E32-L25L 



E32-L24L 

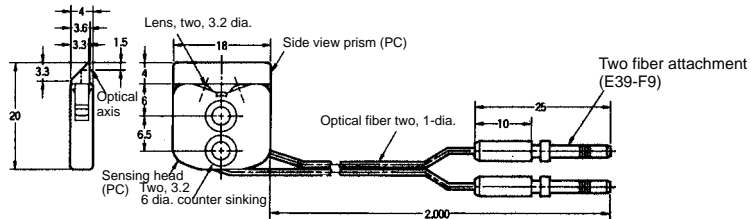

Fine Through-beam

 Indicates models that allow free cutting. Models without this mark do not allow free cutting.

E32-T22S 

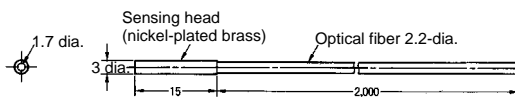

E32-T24S 

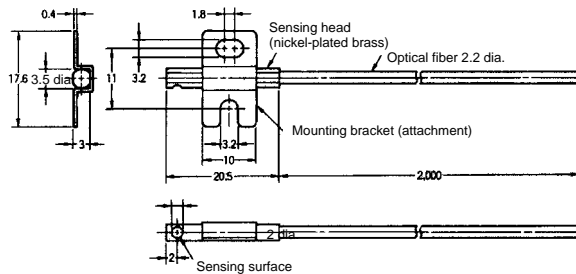

■ Slot Sensor

E32-G14

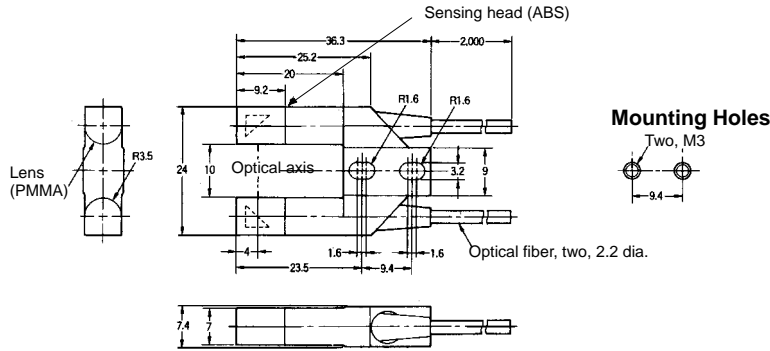

■ Liquid Level Fiber Units

Fluid-contact model

E32D82F1

F32D82F2

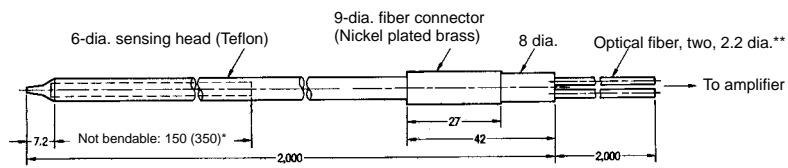

*: Values in parentheses indicate dimensions for the E32-D82F2.

** : The optical fiber on the Amplifier side (2m) is a plastic fiber and can be freely cut.

Tube-mounting model

E32-L25T

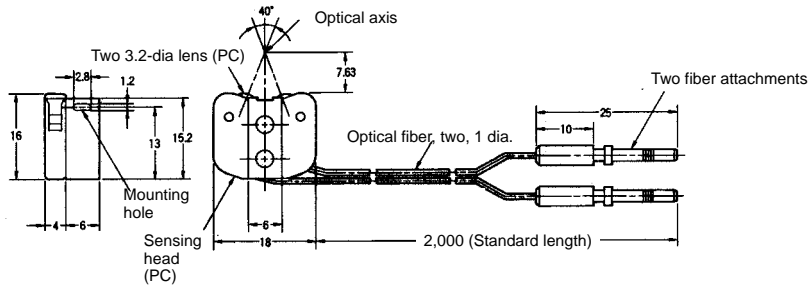

■ Reflector

Reflector (Miniature)

E39-R3 (Supplied with E32-R21)

Note: Mounting bracket is attached.

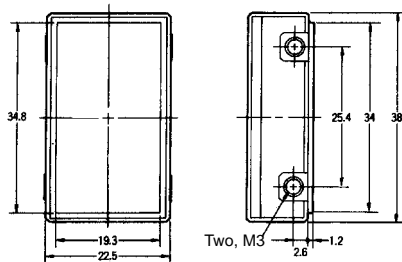
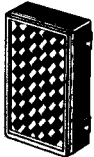

Reflector

E39-R1 (Supplied with E32-R16)

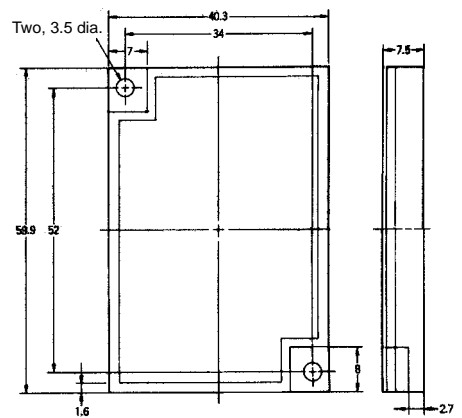
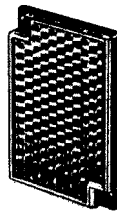

■ Attachments

E39-F1
Long-distance Lens Unit

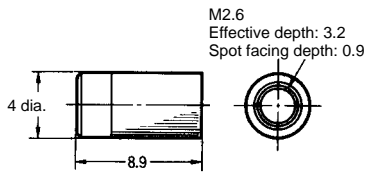

Note: One set includes two units.

E39-F2
Side-view Unit

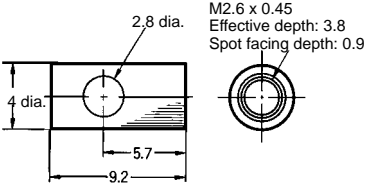

Note: One set includes two units.

E39-F3
Lens-equipped Reflective Unit

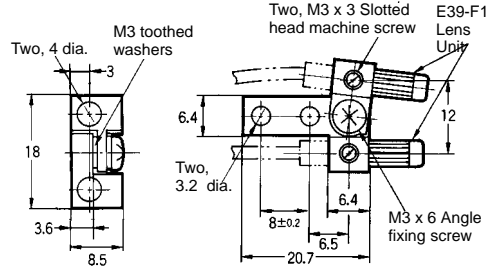

E39-F5
Side-view Reflective Unit

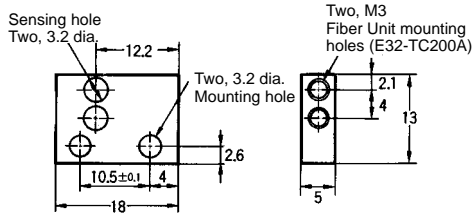

Note: When mounting, remove all of the accompanying screws first and then screw the E32-TC200A into the E39-F5 until the stopper comes into contact.

E39-F3A
Small Spot Lens Unit

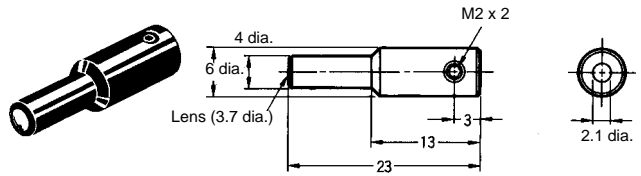

Installation

■ Connection

Connection with S3D2 Sensor Controller

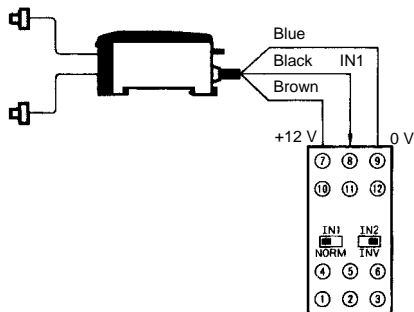

Note: A maximum of two E3X-NH Sensors can be connected.

Power supply voltage	Output	Functions	Model	
100 to 240 VAC	Relay	AND, OR	S3D2-AK	
		AND, OR, and timer	S3D2-CK	
		Flip-flop	S3D2-BK	
	Transistor	AND, OR, and timer	S3D2-CC	
	24 VDC	Relay	2 inputs, 2 outputs,	S3D2-DK
			2 inputs, 2 outputs, and timer	S3D2-EK
			AND, OR	S3D2-AKD
			AND, OR, and timer	S3D2-CKD

Precautions

Be sure to heed the following precautions to fully utilize the capabilities of the E3X-NH/NHB.

General

Do not impose any voltage exceeding the rated voltage on the E3X-NH/NHB. Do not impose 100 VAC or more on models that operate with DC. In both cases, the E3X-NH/NHB may be damaged.

Do not short-circuit the load connected to the E3X-NH/NHB, otherwise the E3X-NH/NHB may be damaged.

When supplying power to the E3X-NH/NHB, make sure that the polarity of the power is correct, otherwise the E3X-NH/NHB may be damaged.

The load must be connected to the E3X-NH/NHB in operation, otherwise the E3X-NH/NHB may be damaged.

■ Fiber Unit

Tightening Force

The tightening force applied to the Fiber Unit should be as follows:

Screw-mounting Model

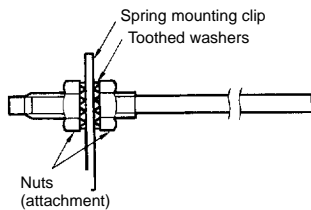

Cylindrical Model

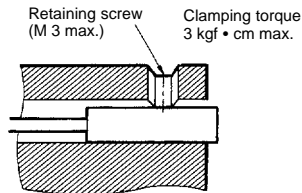

Fiber Units	Clamping torque
M3/M4 screw	0.78 N • m (8 kgf • cm)
M6 screw	0.98 N • m (10 kgf • cm)
2-mm-dia. column	0.29 N • m (3 kgf • cm)
3-mm-dia. column	0.29 N • m (3 kgf • cm)
E32-D14L	0.98 N • m (10 kgf • cm)
E32-T12F	0.78 N • m (8 kgf • cm)
E32-D12F	0.78 N • m (8 kgf • cm)
E32-T16	0.49 N • m (5 kgf • cm)
E32-R21	0.59 N • m (6 kgf • cm)
E32-M21	Up to 5 mm to the tip: 0.49 N • m (5 kgf • cm) Up to 5 mm from the tip: 0.78 N • m (8 kgf • cm)
E32-L25A	0.78 N • m (8 kgf • cm)
E32-T16P E32-T24S E32-L24L E32-L25L	0.29 N • m (3 kgf • cm)

Use a proper-sized spanner.

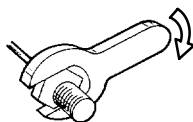

Fiber Connection and Disconnection

The E3X-NH/NHB Amplifier has a lock button. Connect or disconnect the fibers to or from the E3X-NH/NHB Amplifier using the following procedures:

1. Connection

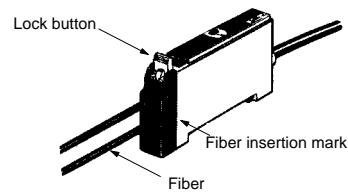

Remove the protective cover, insert the fiber into the Amplifier, and lower the lock button until a click is heard.

After cutting the fiber using the E39-F4 Fiber Cutter, put an insertion mark on the fiber as a guide for correct insertion into the Amplifier, and then insert the fiber up to this mark.

2. Disconnection

Remove the protective cover and raise the lock lever to pull off the fiber. (Before removing the fiber, be sure to confirm that the lock is released so as to maintain the fiber properties.)

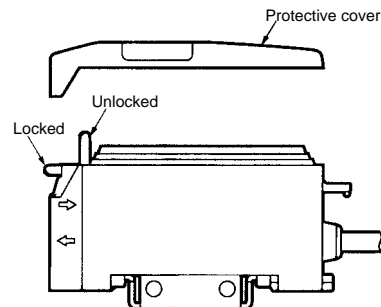

3. The fiber must be locked or released in a temperature range of -10°C to 40°C .

Fiber Insertion

If the portion from the tip to the insertion mark of the fibers are not inserted into the Amplifier Unit, the sensing distance will be reduced.

2.2-mm-dia. Fiber

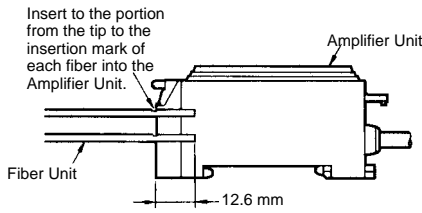

Thin Fiber with the E39-F9 Attachment

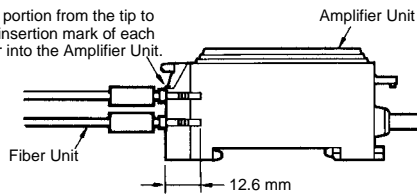

Fiber with Fixed Length

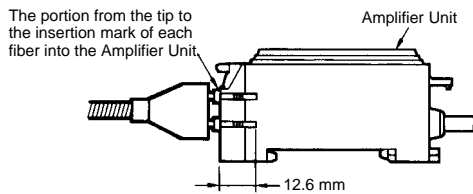

Cutting Fiber

Insert a fiber into the Fiber Cutter and determine the length of the fiber to be cut.

Press down the Fiber Cutter in a single stroke to cut the fiber.

An insertion mark can be placed on the fiber to serve as a reference when inserting the fiber into the Amplifier. Use the following procedure.

Confirm through the Cutter hole that the fiber is inserted beyond the insertion mark hole so that the insertion mark is properly indicated, and then press firmly down on the Cutter.

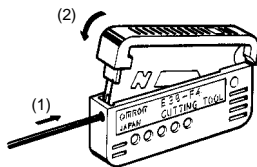

Insert the fiber into the Amplifier up to the insertion mark. Proper fiber performance will not be achieved unless the fiber is inserted all the way to the insertion mark. (This method is applicable to standard, 2.2-mm-diameter fibers only.)

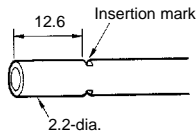

The cutting holes cannot be used twice. If the same hole is used twice, the cutting face of the fiber will be rough and the sensing distance will be reduced. Always use an unused hole.

Use either one of the two holes on the right (refer to the following figure) to cut a thin fiber as follows:

1. An attachment is temporarily fitted to a thin fiber before shipment.

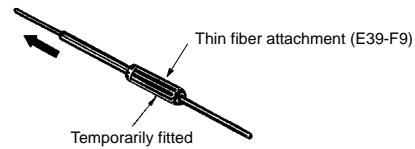

2. Secure the attachment after adjusting the position of it in the direction indicated by the arrow.



3. Insert the fiber into the E39-F4 to cut.

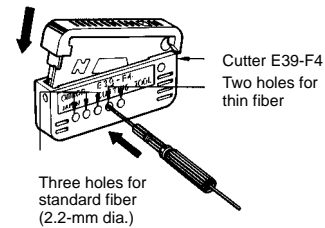

4. Finished state (proper cutting state)



Note: Insert the fiber in the direction indicated by the arrow.

Connection

Do not pull or press the Fiber Units. The Fiber Units have a withstand force of 9.8 N (1 kgf) or 29.4 N (3 kgf) (pay utmost attention because the fibers are thin).

Do not bend the Fiber Units beyond the permissible bending radius.

Do not bend the edge of the Fiber Units (excluding the E32-T□R and E32-D□R).

Correct

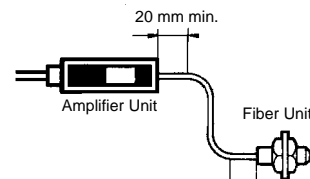

Incorrect

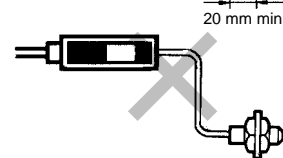

Do not apply excess force on the Fiber Units.

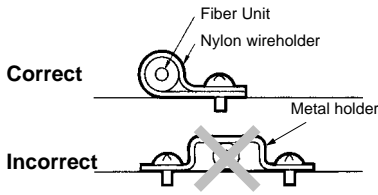

The Fiber Head could be break by excessive vibration. To prevent this, the following is effective:

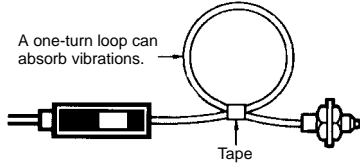

Bending Radius

E39-F11 Sleeve Bender

The bending radius of the stainless tube should be as large as possible. The smaller the bending radius becomes, the shorter the sensing distance will be.

Insert the tip of the stainless tube to the Sleeve Bender and bend the stainless tube slowly along the curve of the Sleeve Bender (refer to the figure).

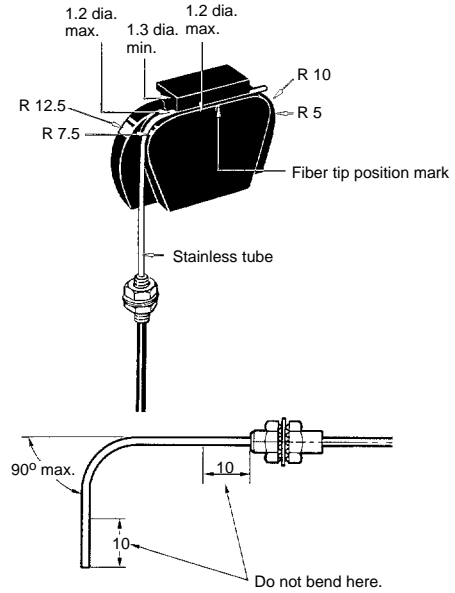

Amplifier Units

Mounting

Mounting

1. Mount the front part on the mounting bracket (attachment) or a DIN track.
2. Press the back part onto the mounting bracket or the DIN track.

Note: Do not mount the back part onto the mounting bracket or the DIN track first and then mount the front part on the mounting bracket or the DIN track, or the mounting strength of the Amplifier Unit may decrease.

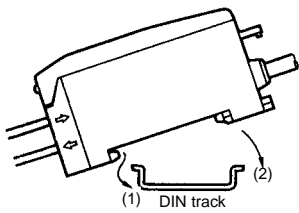

Dismounting

By pressing the Amplifier Unit in direction (3) and lifting the fiber insertion part in direction "4" as shown in the following, the Amplifier can be dismounted with ease.

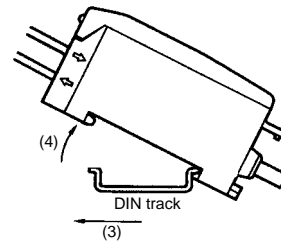

In the case of side mounting, attach the mounting bracket on the Amplifier first, and secure the Amplifier with M3 screws and washers. The diameter of the washers should be 6 mm max.

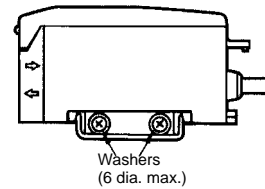

Turning the Power ON

After the E3X-NH/NHB is turned ON, the E3X-NH/NHB will be ready to operate in 100 ms maximum. If power is supplied to the E3X-NH and the load is connected to the E3X-NH/NHB independently, be sure to turn ON the power supply connected to the E3X-NH/NHB first.

When the power is turned ON, the operation indicator will be ON momentarily. Note that this will not have an effect on performance since no control output will be generated.

Mutual Interference Protection Function

Perform two-point teaching if two to three Fiber Units are closely mounted together, at which time supply power only to the Unit in teaching operation in turn or block the emitters of the Fiber Units not in teaching operation.

EEPROM Writing Error

Write errors may result at the time of teaching due to power failure or static noise, in which case the Unit beeps and the operation indicators flash. If any of these occur, re-input teaching using the teaching button on the Amplifier.

Minute Sensing Object

This datasheet shows typical examples for detecting minute objects. These typical examples are for reference use only, because these example operations were tested on Units sampled at random from a lot and the values described are average values. Do not assume that all Units ensure such operations.

Others

When the power is OFF:

The moment power is turned OFF, the E3X-NH/NHB may output a pulse signal which could affect the operation of the devices connected to it. This will occur more often if power is supplied to the E3X-NH from an external power supply, thus affecting the connected timer and counter. Use a built-in power supply as much as possible to avoid this.

In a case where the cord is extended, use a wire with 0.3 mm² min. The total length of the cord should be 100 m max.

Power supply:

If a standard switching regulator is used as a power supply, the frame ground (FG) terminal and the ground (G) terminal must be grounded, or otherwise the E3X-NH can malfunction influenced by the switching noise of the power supply.

The supplied voltage must be within the rated voltage range. Unregulated full- or half-wave rectifiers must not be used as power supplies.

Do not lay wiring to the Optical Sensor together with power lines in the same piping or ducts. Doing so will cause induction between the lines, possibly resulting in faulty operation or destruction. Always lay wiring to the Optical Sensor in separate or dedicated piping.

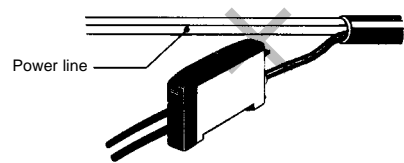

■ Attachment Units

Applications

E39-F10 Fiber Connector

Use the following procedure (refer to the figure) to connect fibers via the Fiber Connector.

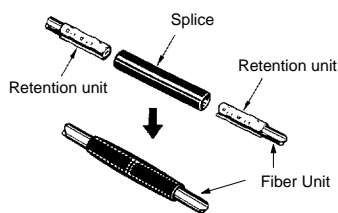

Each Fiber Unit should be as close as possible before they are connected.

Sensing distance will be reduced by approximately 25% when fibers are connected.

Only fibers with a 2.2-mm dia. can be connected. (Refer to page 9 for applicable Fiber Units.)

Protective Spiral Tube

Insert a fiber to the Protective Spiral Tube from the head connector side (screwed) of the tube.

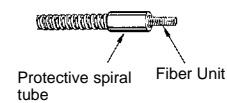

Push the fiber into the Protective Spiral Tube. The tube should be straight so that the fiber is not twisted when inserted. Then turn the end cap of the spiral tube.

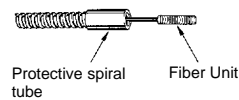

Secure the Protective Spiral Tube on a suitable place with the attached nut.

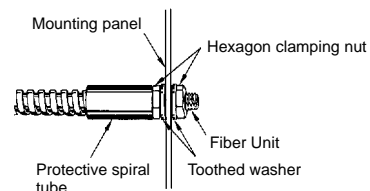

Use the attached saddle to secure the end cap of the Protective Spiral Tube. To secure the Protective Spiral Tube at a position other than the end cap, apply tape to the tube so that the portion becomes thicker in diameter.

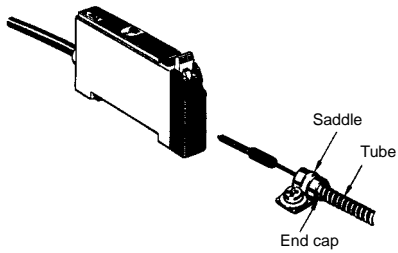
**WARNING**

The E3X-NH/NHB is not a safety component for ensuring the safety of people as defined in EC Directive 91/368/EEC, or as covered by separate European standards or by any other regulations or standards.

■ Reflector

Observe the Following Precautions when Using the Reflector (E39-R3)

Use detergent, etc., to remove any dust or oil from the surfaces where tape is applied. Adhesive tape will not be attached properly if oil or dust remains on the surface.

The E39-R3 cannot be used in places where it is exposed to oil or chemicals.

ALL DIMENSIONS SHOWN ARE IN MILLIMETERS.

To convert millimeters into inches, multiply by 0.03937. To convert grams into ounces, multiply by 0.03527.

Cat. No. E258-E1-3 **In the interest of product improvement, specifications are subject to change without notice.**

OMRON Corporation

Industrial Sensors Division
Sensing Devices and Components Division H.Q.
28th Fl., Crystal Tower Bldg.
1-2-27, Shiromi, Chuo-ku,
Osaka 540-6028 Japan
Phone: (81)6-949-6012 Fax: (81)6-949-6021

Printed in Japan
0698-1.5M (0297) Ⓐ