

ESAD92M-02R (20A)

(200V / 20A)

LOW LOSS SUPER HIGH SPEED RECTIFIER

Outline drawings, mm

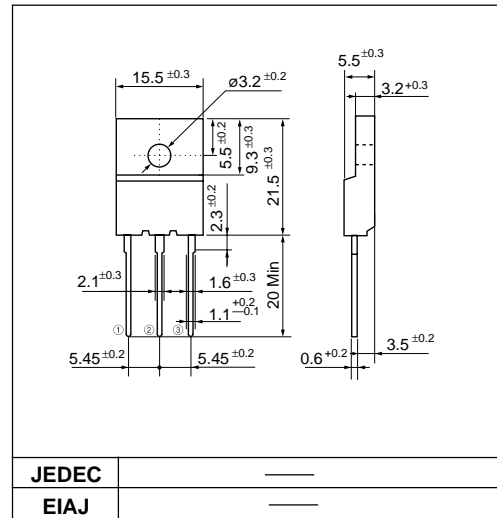

Features

- Insulated package by fully molding
- Low V_F
- Super high speed switching
- High reliability by planer design

Applications

- High speed power switching

Maximum ratings and characteristics

- Absolute maximum ratings

Item	Symbol	Conditions	Rating	Unit
Repetitive peak reverse voltage	V_{RRM}		200	V
Average output current	I_o	Square wave, duty=1/2, $T_j=108^\circ\text{C}$	20*	A
Surge current	I_{FSM}	Sine wave 10ms	100	A
Operating junction temperature	T_j		-40 to +150	$^\circ\text{C}$
Storage temperature	T_{stg}		-40 to +150	$^\circ\text{C}$

*Average forward current of centertap full wave connection

- Electrical characteristics ($T_a=25^\circ\text{C}$ Unless otherwise specified)

Item	Symbol	Conditions	Max.	Unit
Forward voltage drop	V_{FM}	$I_{FM}=10\text{A}$	0.95	V
Reverse current	I_{RRM}	$V_R=V_{RRM}$	100	μA
Reverse recovery time	t_{rr}	$I_F=0.1\text{A}$, $I_R=0.2\text{A}$, $I_{rec}=0.05\text{A}$	40	ns
Thermal resistance	$R_{th(j-c)}$	Junction to case	2.0*	$^\circ\text{C/W}$

Connection diagram

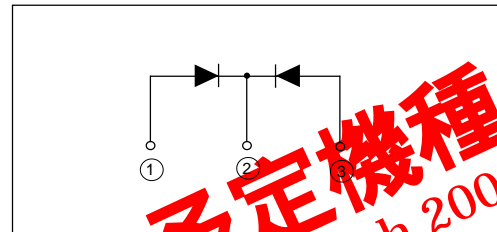

2007年3月 保守廃止予定機種
 This product is scheduled to be obsolete on march 2007.
 Not recommend for new design.

■ Characteristics

Forward characteristics

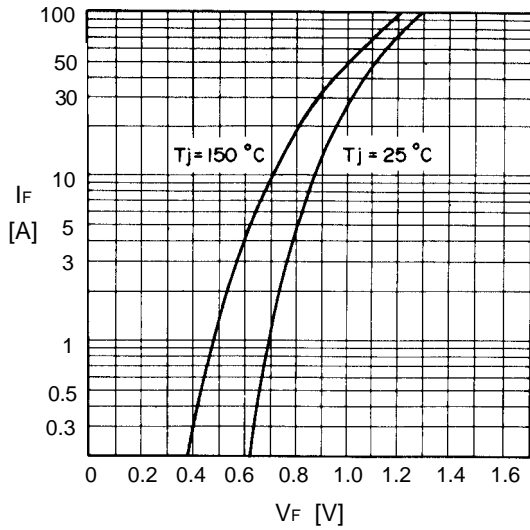

Reverse characteristics

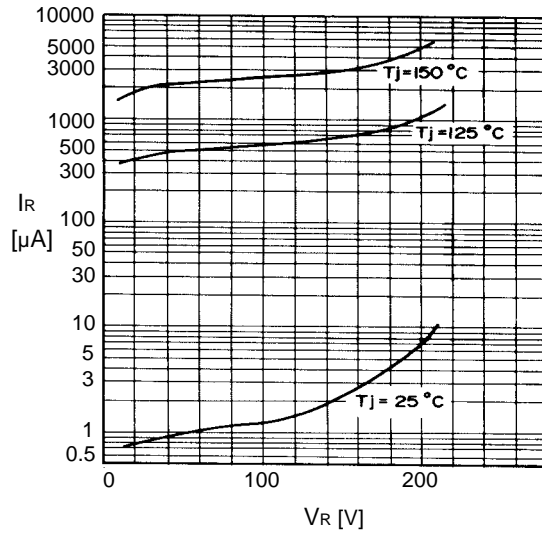

Forward power dissipation

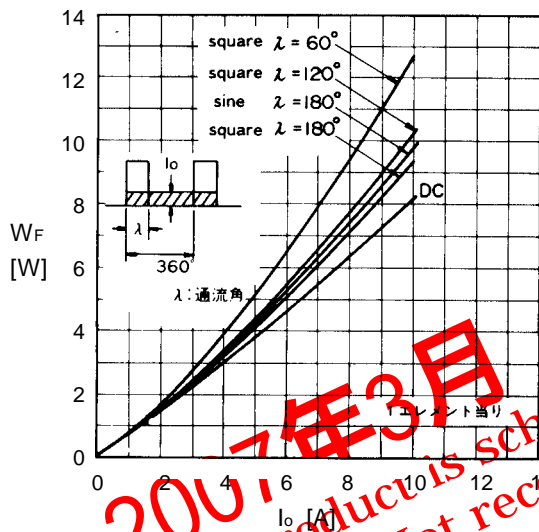

Output current-case temperature

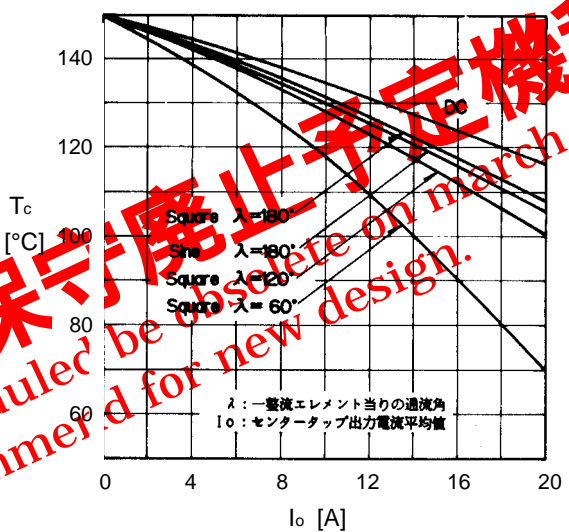

Junction capacitance characteristics

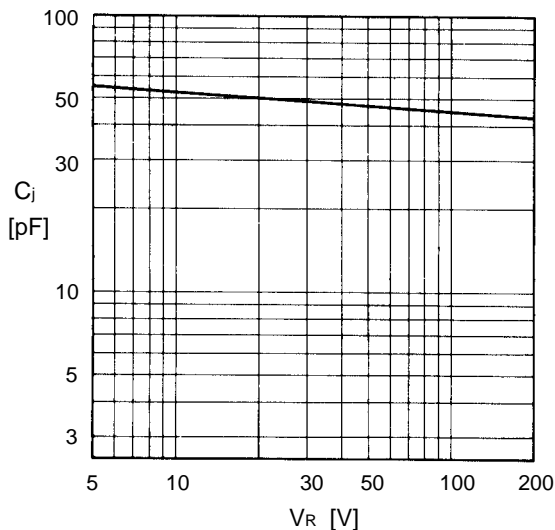

Surge capability

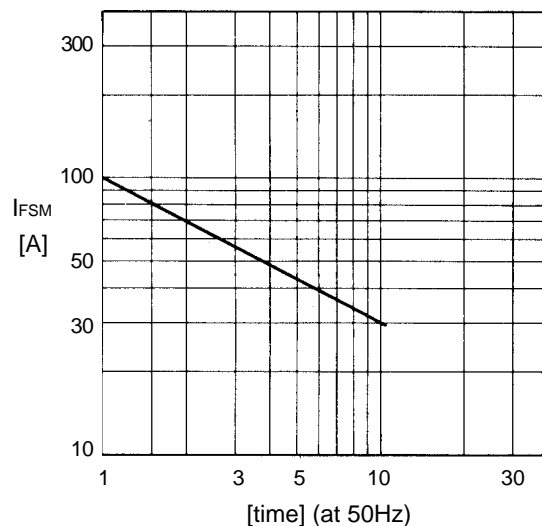

2007年3月保守停止予定機種
This product is scheduled to be obsolete on march 2007.
Not recommended for new design.

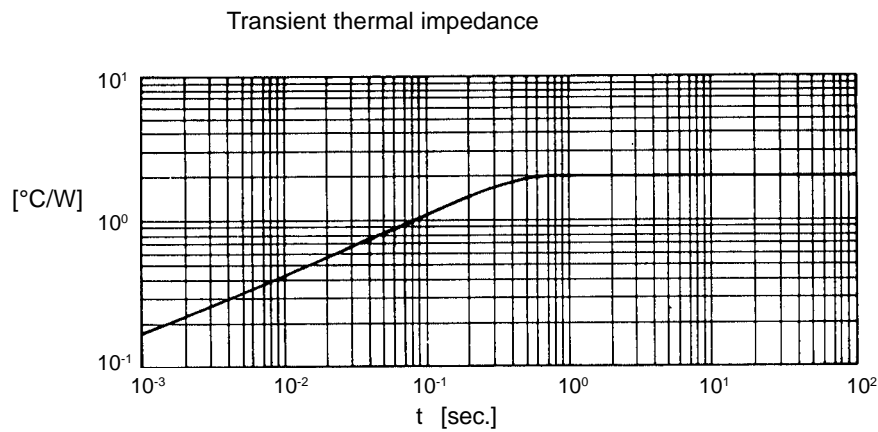

2007年3月 保守廃止予定機種
This product is scheduled be obsolete on march 2007.
Not recommend for new design.