

150mA Low-Noise Low-Dropout Linear Regulator

DESCRIPTION

The EUP7965 is designed for portable and wireless applications with demanding performance and space requirements.

The EUP7965 is stable with a small $1\mu\text{F} \pm 30\%$ ceramic output capacitor. The EUP7965's performance is optimized for battery powered systems to deliver low noise, low dropout voltage, low quiescent current and excellent line and load transient response.

An optional external bypass capacitor reduces the output noise further without slowing down the load transient response. Power supply rejection is better than 65dB at low frequencies. High power supply rejection is maintained down to low input voltage levels common to battery operated circuits. Other features include a logic-controlled shutdown mode, short-circuit and thermal-shutdown protection. The EUP7965 is available in a SOT23-5, SOT23-6 package.

FEATURES

- 2.5 to 5.5V Input Range
- 150mA Guaranteed Output
- 70dB PSRR at 1kHz @ $V_{\text{IN}}=V_{\text{OUT}}+1\text{V}$
- $50\mu\text{V}_{\text{rms}}$ Output Noise (typ) over 10Hz to 100kHz
- 100mV Maximum Dropout with 150mA Load
- Low $85\mu\text{A}$ No-load Supply Current
- $\leq 1.5\mu\text{A}$ Shutdown Current
- Fast Start-up time.
- Stable with $1\mu\text{F}$ Ceramic Capacitors
- Thermal Shutdown and Short-circuit Protection
- Preset Output Voltage 1.5V, 1.8V, 2.5V, 2.8V, 2.85V, 3.0V, 3.3V, 4.8V, 5.0V and adjustable
- SOT23-5, SOT23-6 package
- RoHS Compliant and 100% Lead (Pb)-Free

APPLICATIONS

- Cellular and Cordless Handsets
- Bluetooth, Wireless LAN
- PDAs and Palmtop Computers
- Portable Information Appliances

Block Diagram

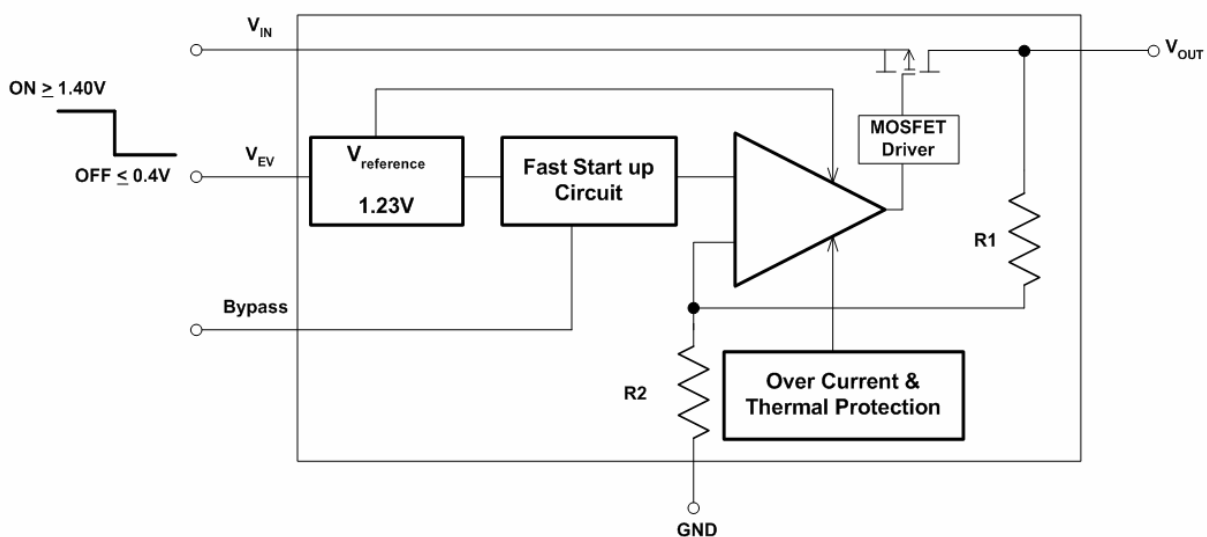

Figure 1.

Typical Application Circuit

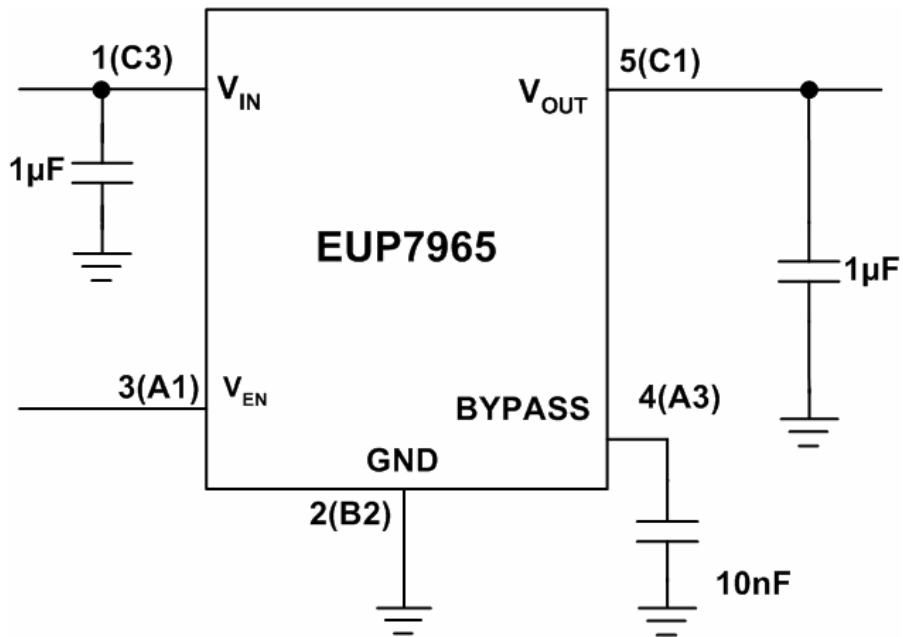

Figure 2.

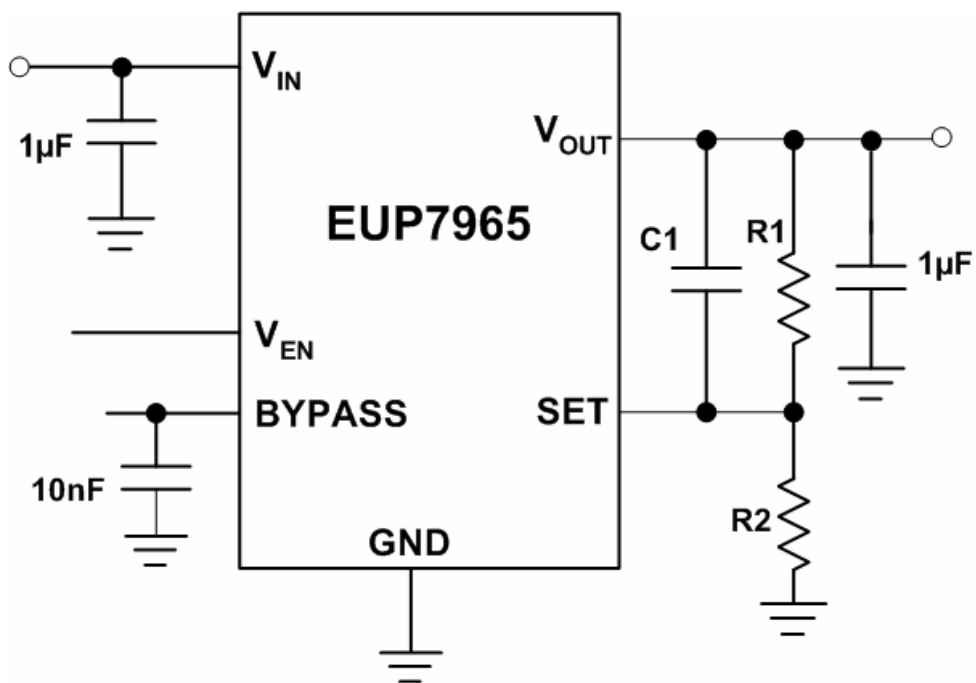

Figure 3.

Pin Configurations

Part Number	Pin Configurations
EUP7965 SOT23-5	
EUP7965 SOT23-6	

Pin Description

PIN	SOT23-5	SOT23-6	DESCRIPTION
V_{IN}	1	1	Input voltage of the LDO
GND	2	2	Common ground
V_{EN}	3	3	Enable input logic, enable high
BYPASS	4	4	Optional bypass capacitor for noise reduction
SET		5	Output voltage set. Not externally connected for the fixed versions. Connect to resistor-divider for adjustable output voltage.
V_{OUT}	5	6	Output voltage of the LDO

Ordering Information

Order Number	Package Type	Marking	Operating Temperature range
EUP7965-15VIR1	SOT23-5	G0	-40 °C to 85°C
EUP7965-18VIR1	SOT23-5	G1	-40 °C to 85°C
EUP7965-25VIR1	SOT23-5	G2	-40 °C to 85°C
EUP7965-28VIR1	SOT23-5	G6	-40 °C to 85°C
EUP7965-285VIR1	SOT23-5	G8	-40 °C to 85°C
EUP7965-30VIR1	SOT23-5	G5	-40 °C to 85°C
EUP7965-33VIR1	SOT23-5	G3	-40 °C to 85°C
EUP7965-48VIR1	SOT23-5	G7	-40 °C to 85°C
EUP7965-50VIR1	SOT23-5	G4	-40 °C to 85°C
EUP7965VIR1	SOT23-6	GA	-40 °C to 85°C

EUP7965-

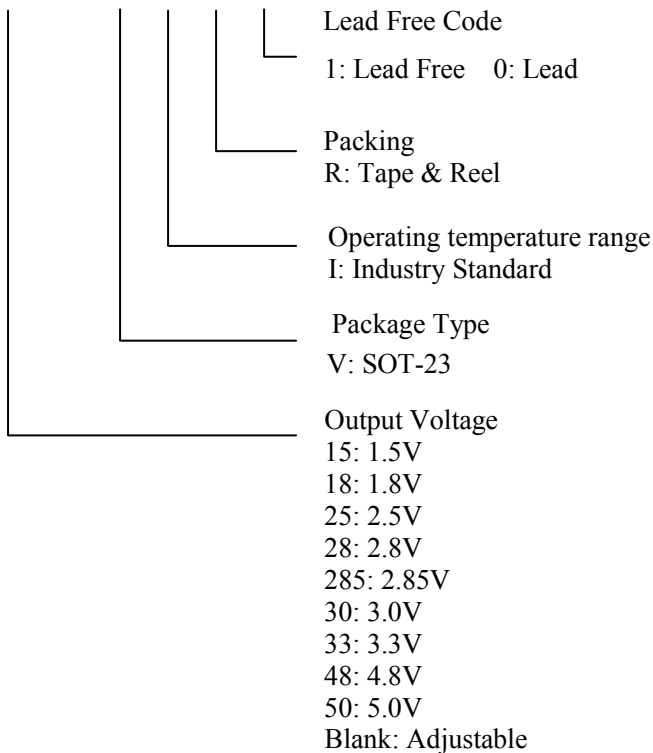

Absolute Maximum Ratings

- V_{IN}, V_{EN} ----- -0.3 to 6V
- V_{OUT} ----- -0.3 to $(V_{IN}+0.3) \leq 6V$
- Junction Temperature ----- 150°C
- Storage Temperature ----- -65°C to +150°C
- Lead Temp ----- 235°C
- Pad Temp ----- 235°C
- Maximum Power Dissipation SOT23-5 ----- 364mW
- Thermal Resistance $\theta_{JA}(SOT23-5)$ ----- 220°C/W
- ESD Rating
Human Body Model ----- 2kV

Operating Ratings

- V_{IN} ----- 2.5 to 5.5V
- V_{EN} ----- 0 to $(V_{IN}+0.3) \leq 5.5V$
- Junction Temperature ----- -40°C to +125°C

Electrical Characteristics

Unless otherwise specified, all limits guaranteed for $V_{IN} = V_{OUT(nom)} + 0.5V$, $C_{IN} = 1\mu F$, $I_{OUT} = 1mA$, $C_{OUT} = 1\mu F$, $C_{BYPASS} = 0.01\mu F$. Typical values and limits appearing in standard typeface are for $T_J = 25^\circ C$.

Symbol	Parameter	Conditions	EUP7965			Unit
			Min	Typ	Max.	
V_{OUT}	Output Voltage Tolerance	$I_{OUT} = 1mA$	-2		2	% of $V_{OUT(nom)}$
	Line Regulation Error	$V_{IN} = (V_{OUT(nom)} + 0.5V)$ to 5.5V, For 4.8 to 5.0 options For all other options	-0.19 -0.1		0.19 0.1	%/V
	Load Regulation Error	$I_{OUT} = 1mA$ to 150mA		0.0025	0.005	%mA
PSRR	Power Supply Rejection Ratio	$V_{IN} = V_{OUT(nom)} + 1V$, $f = 1kHz$, $I_{OUT} = 50mA$ *		70		dB
I_Q	Quiescent Current	$V_{EN} = 1.4V$, $I_{OUT} = 0mA$ For 4.8 to 5.0 options For all other options		100 85	165 150	μA
		$V_{EN} = 1.4V$, $I_{OUT} = 0$ to 150mA For 4.8 to 5.0 options For all other options		155 140	250 200	
		$V_{EN} = 0.4V$		0.06	1.5	
	Dropout Voltage	$I_{OUT} = 1mA$		0.5	2	mV
		$I_{OUT} = 50mA$		25	35	
		$I_{OUT} = 100mA$		50	70	
		$I_{OUT} = 150mA$		75	100	

Electrical Characteristics

Unless otherwise specified, all limits guaranteed for $V_{IN} = V_{OUT(nom)} + 0.5V$, $C_{IN} = 1\mu F$, $I_{OUT} = 1mA$, $C_{OUT} = 1\mu F$, $C_{BYPASS} = 0.01\mu F$. Typical values and limits appearing in standard typeface are for $T_J = 25^\circ C$.

Symbol	Parameter	Conditions	EUP7965			Unit
			Min	Typ	Max.	
I_{SC}	Short Circuit Current Limit	Output Grounded (Steady State)		600		mA
T_{ON}	Turn-On Time	$C_{BYPASS} = 0.01\mu F$		150		μs
e_n	Output Noise Voltage	BW = 10Hz to 100kHz, $C_{OUT} = 1\mu F$		50		μV_{rms}
I_{EN}	Maximum Input Current at EN	$V_{EN} = 0.4$ and $V_{IN} = 5.5$		± 1		nA
V_{IL}	Maximum Low Level Input Voltage at EN	$V_{IN} = 2.5$ to $5.5V$			0.4	V
V_{IH}	Minimum High Level Input Voltage at EN	$V_{IN} = 2.5$ to $5.5V$	1.4			V
TSD	Thermal Shutdown Temperature			160		$^\circ C$
	Thermal Shutdown Hysteresis			20		$^\circ C$

Typical Operating Characteristics

Unless otherwise specified, $C_{IN}=C_{OUT}=1\mu F$ Ceramic, $C_{BYPASS}=10nF$, $V_{IN}=V_{OUT}+0.2V$, $T_A=25^\circ C$, Enable pin is

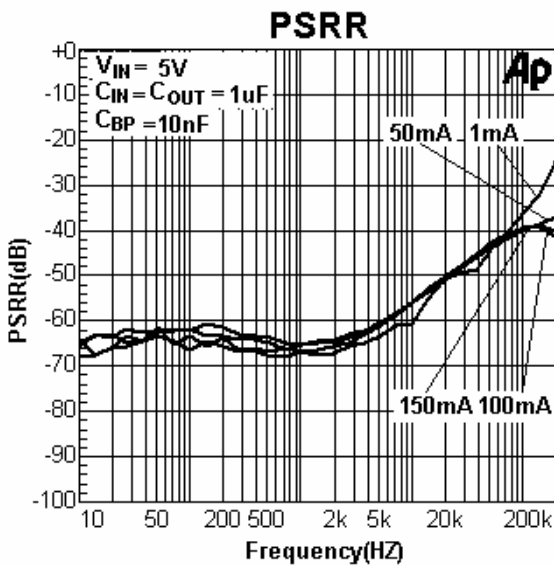
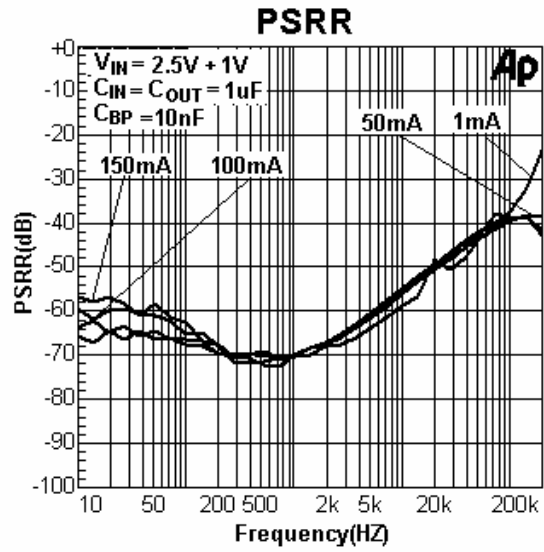
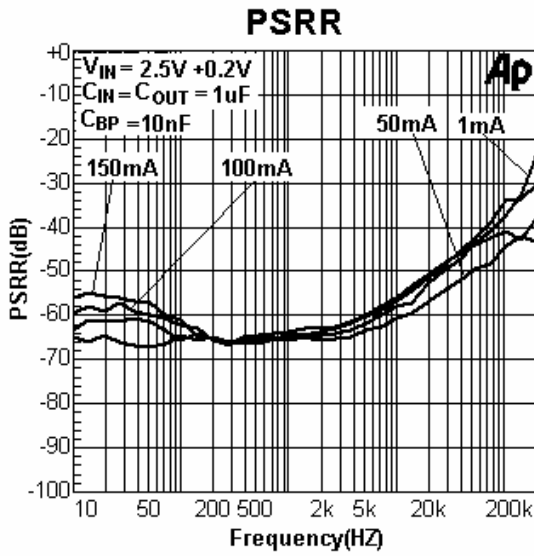

Output Voltage Change vs. Temperature

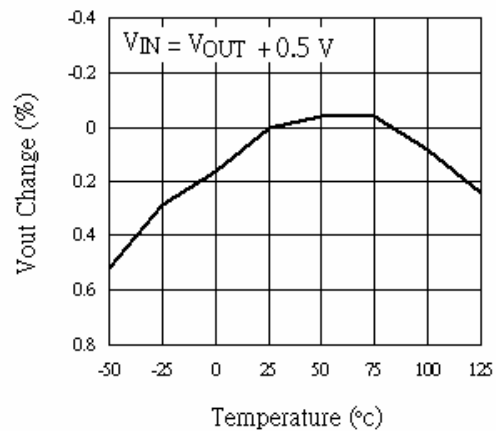

Dropout Voltage vs. Load Current

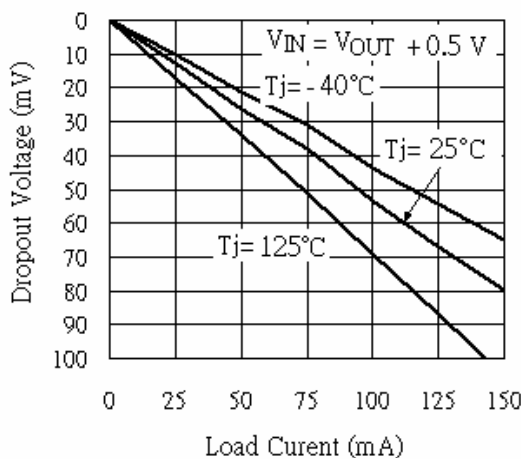

Ground Current vs. Load Current

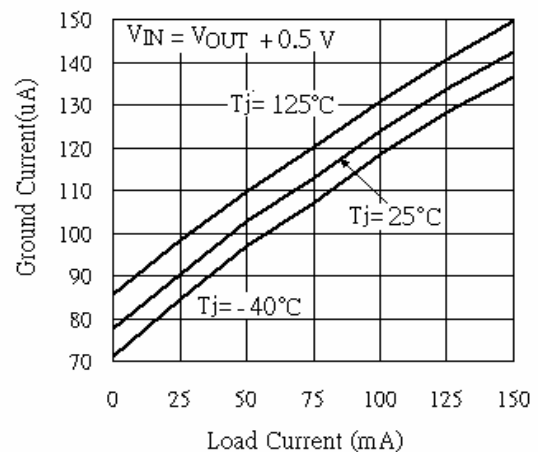

Ground Current vs. VIN @ 25 °C

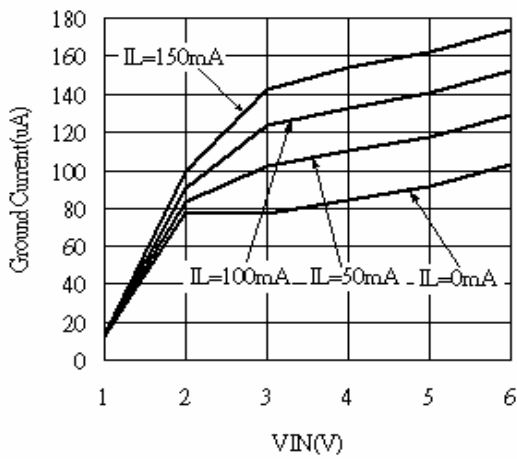

Ground Current vs. VIN @ - 40 °C

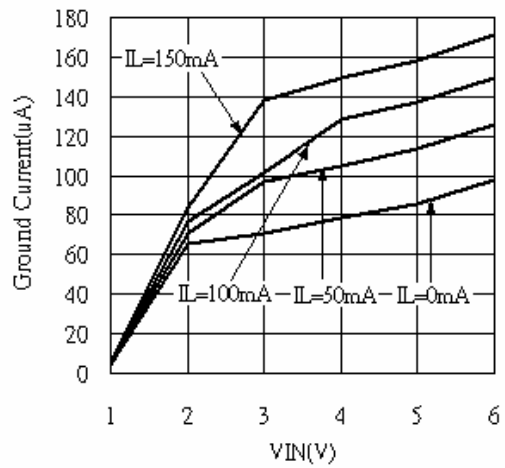

Ground Current vs. VIN @ 125 °C

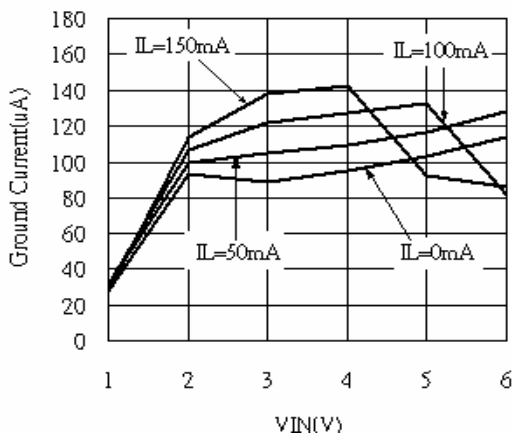

Start Up Time (VIN=VOUT+0.2V)

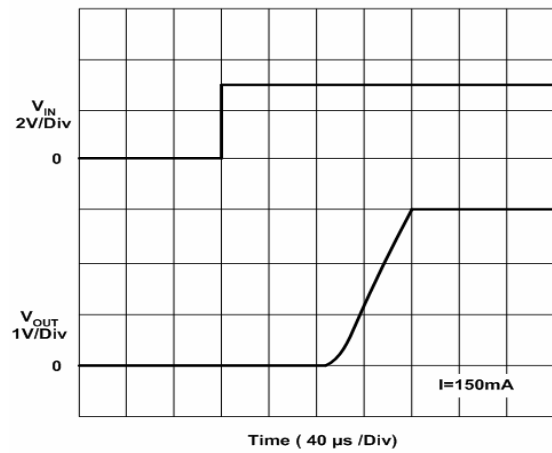

Start Up Time (VIN=4.2V)

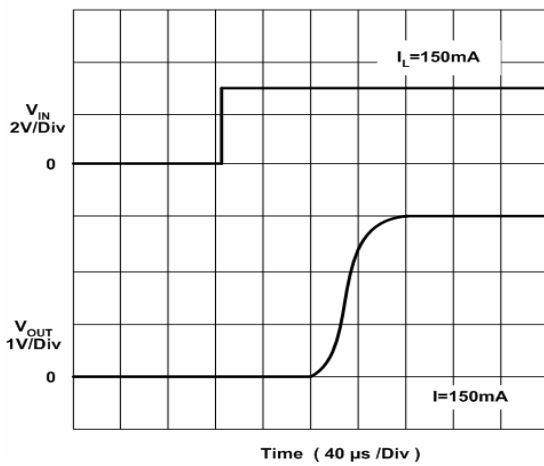

Start Up Time (VIN=VOUT+0.2V)

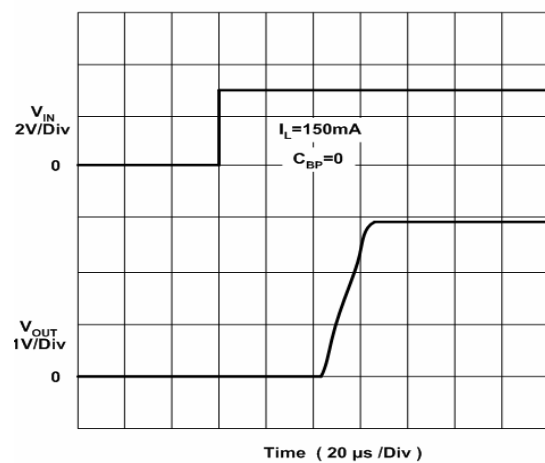

Start Up Time ($V_{IN}=4.2V$)

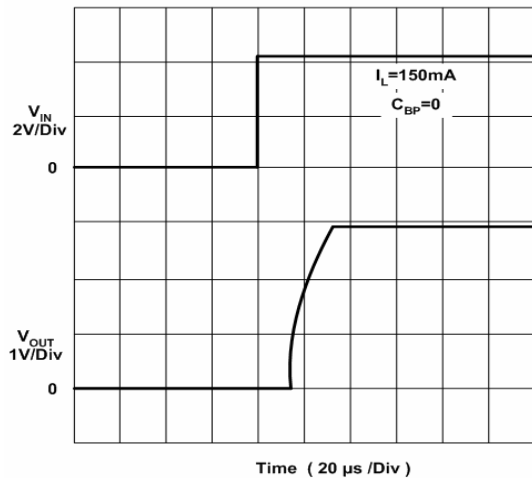

Start Up Time ($V_{IN}=V_{OUT}+0.2V$)

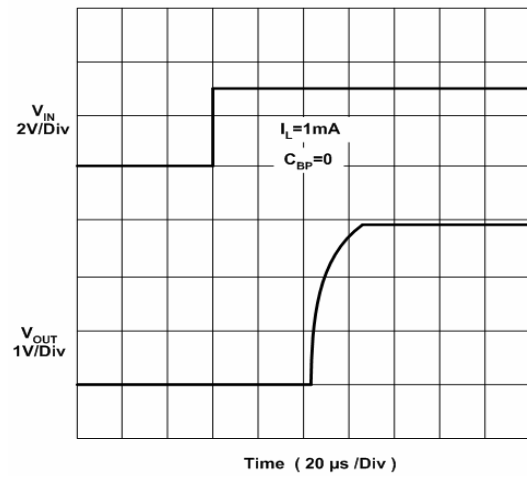

Start Up Time ($V_{IN}=4.2V$)

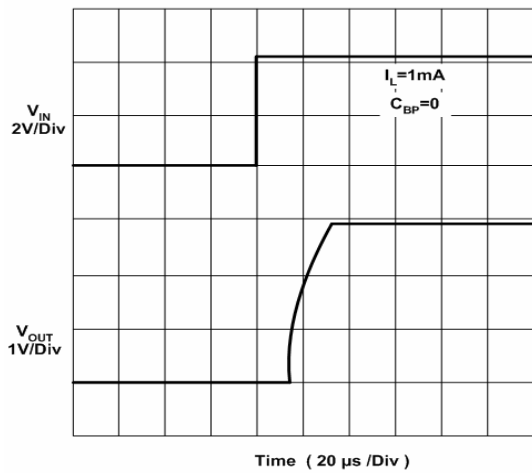

Line Transient Response

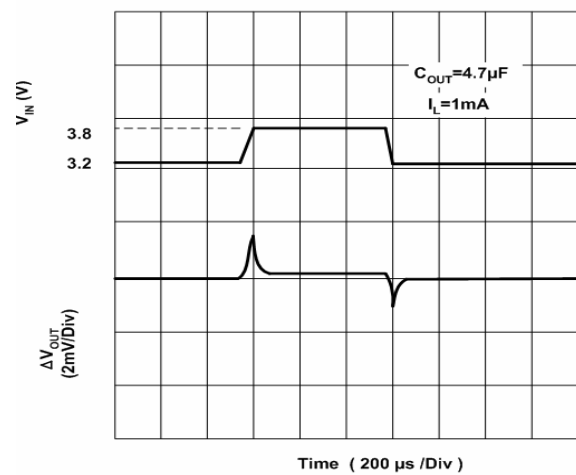

Line Transient Response

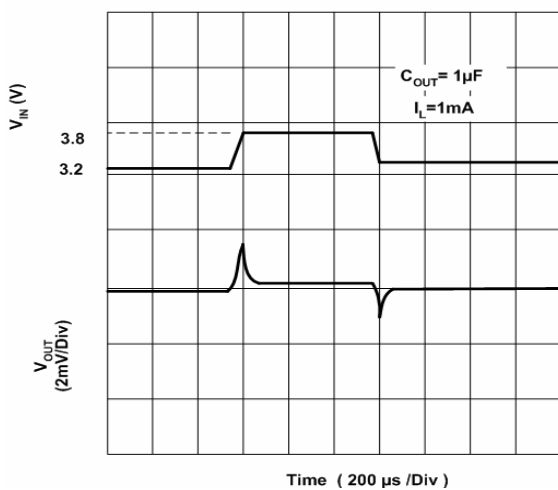

Load Transient Response ($V_{IN}=3.2V$)

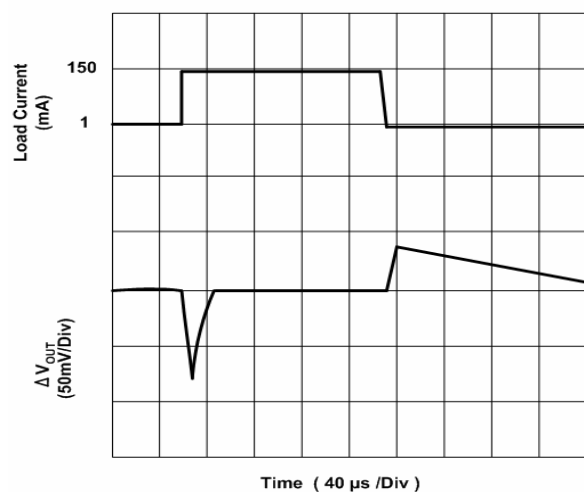

Load Transient Response ($V_{IN}=4.2V$)

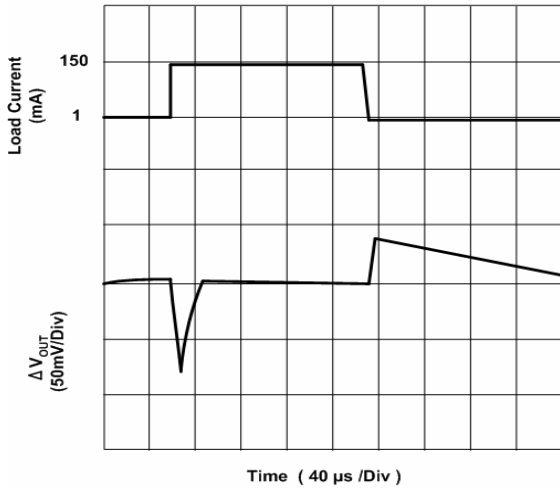

Load Transient Response ($V_{IN}=3.2V$)

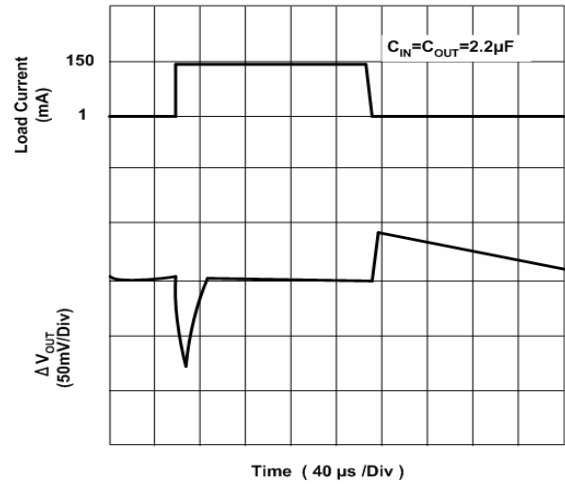

Load Transient Response ($V_{IN}=4.2V$)

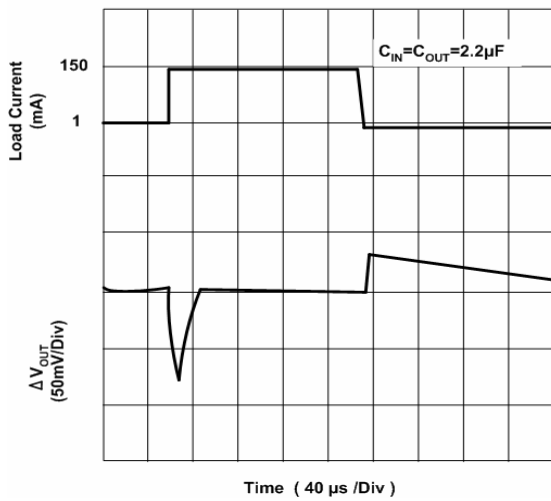

Enable Response ($V_{IN}=V_{OUT}+0.2V$)

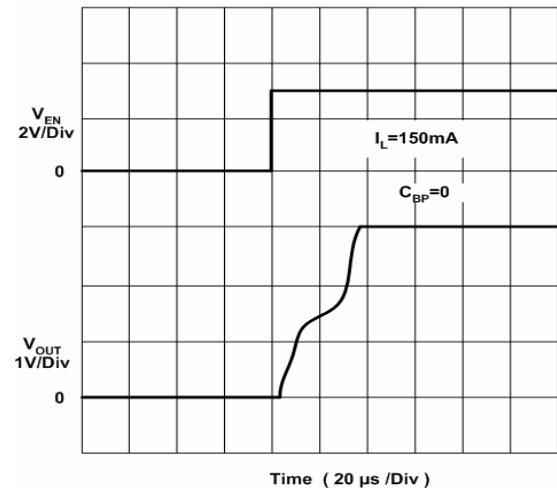

Enable Response ($V_{IN}=4.2V$)

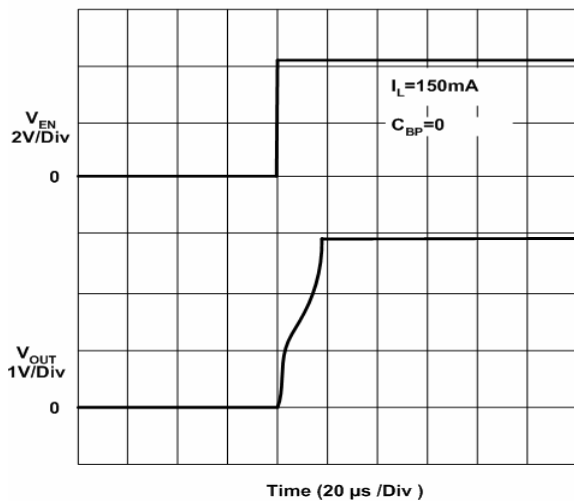

Enable Response ($V_{IN}=V_{OUT}+0.2V$)

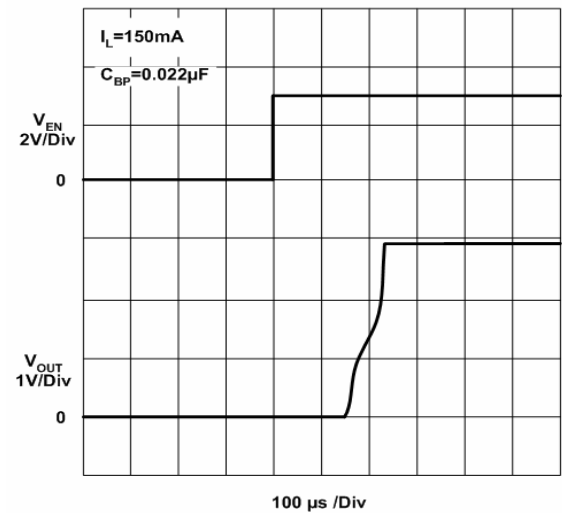

Enable Response ($V_{IN} = 4.2V$)

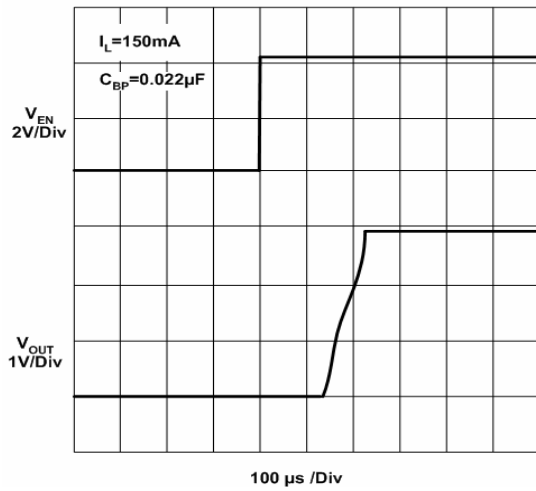

Output Noise

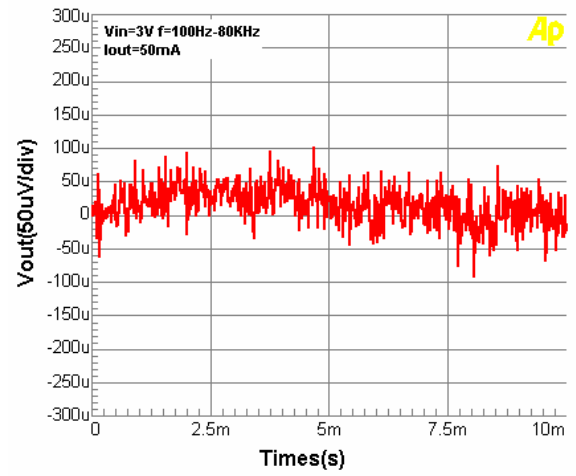

Output Noise

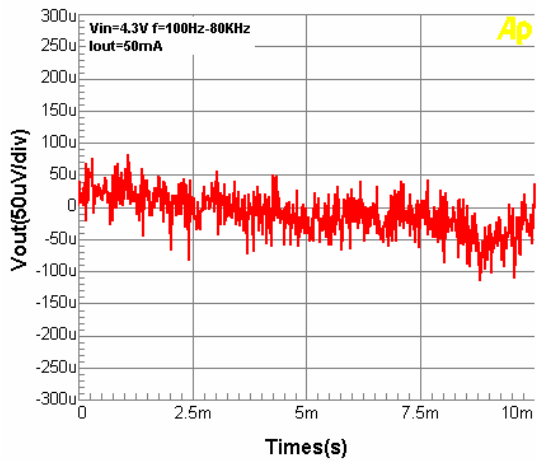

Application Note

External Capacitors

Like any low-dropout regulator, the EUP7965 requires external capacitors for regulator stability. The EUP7965 is specifically designed for portable applications requiring minimum board space and smallest components. These capacitors must be correctly selected for good performance.

Input Capacitor

An input capacitance of $\approx 1\mu\text{F}$ is required between the EUP7965 input pin and ground (the amount of the capacitance may be increased without limit).

This capacitor must be located a distance of not more than 1cm from the input pin and returned to a clean analog ground. Any good quality ceramic, tantalum, or film capacitor may be used at the input.

If a tantalum capacitor is used at the input, it must be guaranteed by the manufacturer to have a surge current rating sufficient for the application.

There are no requirements for the ESR on the input capacitor, but tolerance and temperature coefficient must be considered when selecting the capacitor to ensure the capacitance will be $\approx 1\mu\text{F}$ over the entire operating temperature range.

Output Capacitor

The EUP7965 is designed specifically to work with very small ceramic output capacitors. A ceramic capacitor (temperature characteristics X7R, X5R, Z5U, or Y5V) in 1 to $22\mu\text{F}$ range with $5\text{m}\Omega$ to $500\text{m}\Omega$ ESR range is suitable in the EUP7965 application circuit.

The output capacitor must meet the requirement for minimum amount of capacitance and also have an ESR (Equivalent Series Resistance) value which is within a stable range ($5\text{m}\Omega$ to $500\text{m}\Omega$)

No-Load Stability

The EUP7965 will remain stable and in regulation with no external load. This is specially important in CMOS RAM keep-alive applications.

Capacitor Characteristics

The EUP7965 is designed to work with ceramic capacitors on the output to take advantage of the benefits they offer: for capacitance values in the range of $1\mu\text{F}$ to $4.7\mu\text{F}$ range, ceramic capacitors are the smallest, least expensive and have the lowest ESR values (which makes them best for eliminating high frequency noise). The ESR of a typical $1\mu\text{F}$ ceramic capacitor is in the range of $20\text{m}\Omega$ to $40\text{m}\Omega$, which easily meets the ESR requirement for stability by the EUP7965.

The ceramic capacitor's capacitance can vary with temperature. The capacitor type X7R, which operates over a temperature range of -55°C to $+125^\circ\text{C}$, will only vary the capacitance to within $\pm 15\%$. Most large value ceramic capacitors ($\approx 2.2\mu\text{F}$) are manufactured with Z5U or Y5V temperature characteristics. Their capacitance can drop by more than 50% as the temperature goes from 25°C to 85°C . Therefore, X7R is recommended over Z5U and Y5V in applications where the ambient temperature will change significantly above or below 25°C .

Noise Bypass Capacitor

Connecting a $0.01\mu\text{F}$ capacitor between the C_{BYPASS} pin and ground significantly reduces noise on the regulator output. This cap is connected directly to a high impedance node in the bandgap reference circuit. Any significant loading on this node will cause a change on the regulated output voltage. For this reason, DC leakage current through this pin must be kept as low as possible for best output voltage accuracy. The types of capacitors best suited for the noise bypass capacitor are ceramic and film.

Unlike many other LDO's, addition of a noise reduction capacitor does not effect the load transient response of the device.

On/Off Input Operation

The EUP7965 is turned off by pulling the V_{EN} pin low, and turned on by pulling it high. If this feature is not used, the V_{EN} pin should be tied to V_{IN} to keep the regulator output on at all time. To assure proper operation, the signal source used to drive the V_{EN} input must be able to swing above and below the specified turn-on/off voltage thresholds listed in the Electrical Characteristics section under V_{IL} and V_{IH} .

Fast Start up

The EUP7965 output starts up after V_{ref} voltage reaches its final value (1.23V nominal). The start-up time is determined by the time constant of the bypass capacitor. The smaller the capacitor value, the shorter the start-up time, but less noise gets reduced. As a result, start-up time and noise reduction need to be taken into design consideration when choosing the value of the bypass capacitor.

Adjustable Operation

The adjustable version of the EUP7965 has an output voltage range of 1.25V to 5V. The output voltage of the EUP7965 adjustable regulator is programmed using an external resistor divider as shown in Figure3. The output voltage is calculated using:

$$V_O = V_{\text{ref}} \times \left(1 + \frac{R_1}{R_2}\right)$$

Where:

$V_{\text{ref}}=1.23\text{V}$ typ. (the internal reference voltage)

Utilize the following equation for adjusting the output to a particular voltage:

$$P_1 = R_2 \left[\frac{V_O}{1.23\text{V}} - 1 \right]$$

Choose $R_2=100\text{k}$ to optimize accuracy, power supply rejection, noise and power consumption.

In order to improve the stability of the adjustable version, it is suggested that a small compensation capacitor C_1 be placed between V_{OUT} and SET .

Packaging Information

SOT23-5

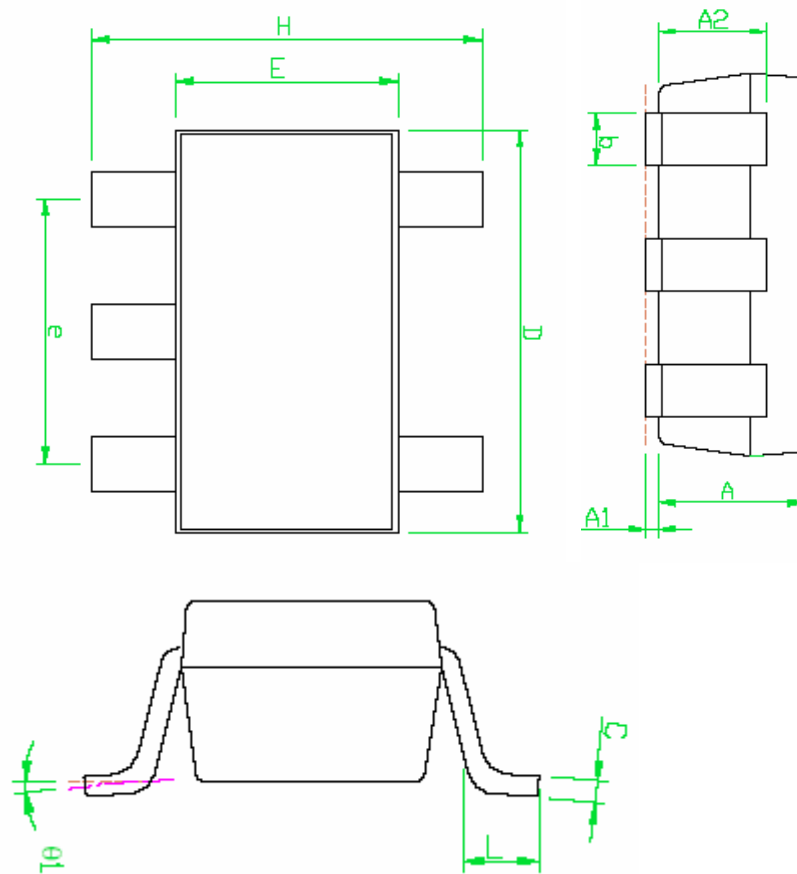
**Note:**

1. Package body sizes exclude mold flash protrusions or gate burrs.
2. Tolerance $\pm 0.1000\text{mm}$ (4 mil) unless otherwise specified.
3. Coplanarity: 0.1000mm
4. Dimension L is measured in gage plane.

Symbols	Dimension in Millimeters		
	Min.	Nom	Max.
A	1.00	1.10	1.30
A1	0.00	-----	0.10
A2	0.70	0.80	0.90
b	0.35	0.40	0.50
C	0.12	0.15	0.20
D	2.70	2.90	3.10
E	1.50	1.60	1.70
e	-----	1.90(Typ.)	-----
H	2.6	2.8	3.00
L	0.37	-----	-----
1	14	5	9

SOT23-6

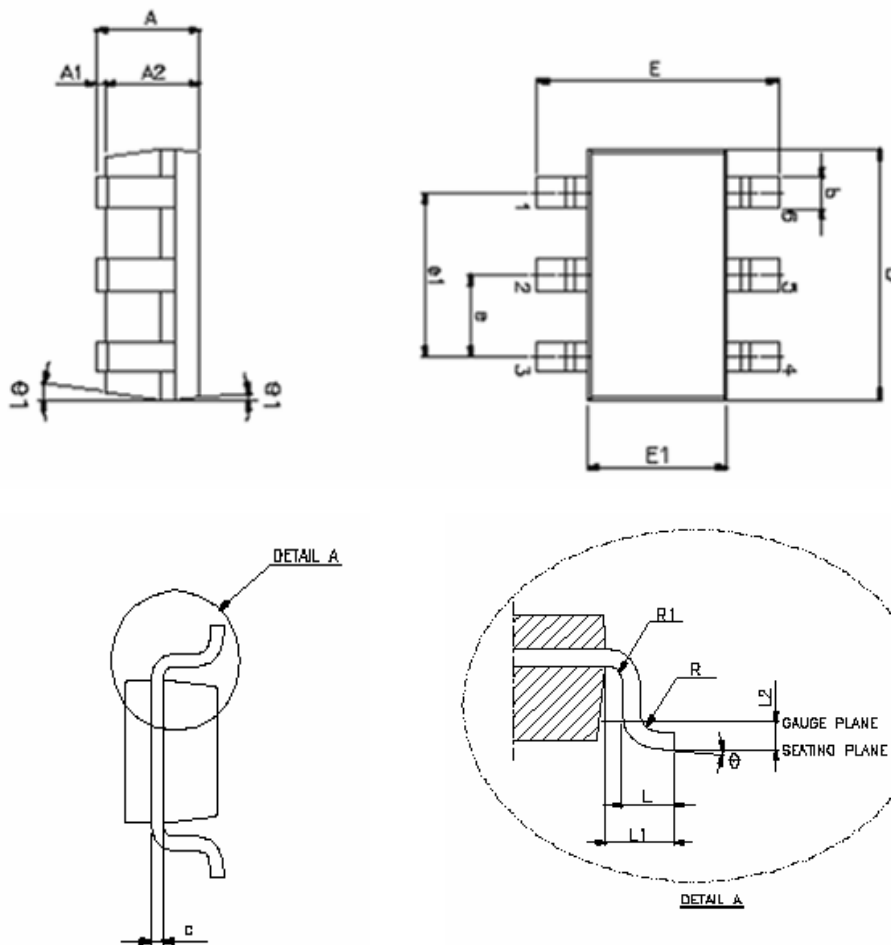

SYMBOLS	DIMENSIONS IN MILLIMETERS		
	MIN.	NOM.	MAX.
A	-----	-----	1.45
A1	-----	-----	0.15
A2	0.90	1.15	1.30
b	0.30	-----	0.50
C	0.08	-----	0.22
D	2.90 BSC		
E	2.80 BSC		
E1	1.60 BSC		
e	0.95 BSC		
E1	1.90 BSC		
L	0.30	0.45	0.60
L1	0.60 REF		
L2	0.25 BSC		
R	0.10	-----	-----
R1	0.10	-----	0.25
	0°	4°	8°
1	5°	10°	15°