

Typical Applications

The HMC197 / HMC197E is ideal for:

- MMDS & WirelessLAN
- PCMCIA Wireless Cards
- Portable Wireless

Functional Diagram

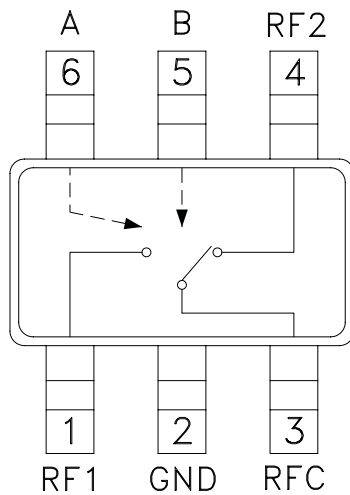

Features

- Low Insertion Loss: 0.4 dB
- Ultra Small Package: SOT26
- Input IP3: +45 dBm
- Positive Control: 0/+3V @ 10 uA

General Description

The HMC197 & HMC197E are low-cost SPDT switches in 6-lead SOT26 plastic packages for use in general switching applications which require very low insertion loss and very small size. The device can control signals from DC to 3.0 GHz and is especially suited for 900 MHz, 1.8 - 2.2 GHz, and 2.4 GHz ISM applications with less than 1 dB loss. The design provides exceptional insertion loss performance, ideal for filter and receiver switching. RF1 and RF2 are reflective shorts when "Off". The two control voltages require a minimal amount of DC current and offer compatibility with most CMOS & TTL logic families. See HMC221 for same performance in an alternate SOT26 pin-out.

Electrical Specifications, $T_A = +25^\circ \text{C}$, $V_{ctl} = 0/+3$ to $+8 \text{Vdc}$, 50 Ohm System

Parameter	Frequency	Min.	Typ.	Max.	Units
Insertion Loss	DC - 1.0 GHz		0.4	0.7	dB
	DC - 2.0 GHz		0.45	0.8	dB
	DC - 2.5 GHz		0.7	0.9	dB
	DC - 3.0 GHz		0.8	1.1	dB
Isolation	DC - 1.0 GHz	24	28		dB
	DC - 2.0 GHz	24	28		dB
	DC - 2.5 GHz	18	22		dB
	DC - 3.0 GHz	14	18		dB
Return Loss	DC - 1.0 GHz	20	30		dB
	DC - 2.0 GHz	16	22		dB
	DC - 2.5 GHz	14	17		dB
	DC - 3.0 GHz	10	13		dB
Input Power for 1dB Compression ($V_{ctl} = 0/+5\text{V}$)	0.5 - 1.0 GHz	25	30		dBm
	0.5 - 3.0 GHz	23	29		dBm
Input Third Order Intercept ($V_{ctl} = 0/+5\text{V}$) (Two-tone Input Power = +7 dBm Each Tone)	0.5 - 1.0 GHz	40	45		dBm
	0.5 - 3.0 GHz	38	43		dBm
Switching Characteristics	DC - 3.0 GHz				
		tRISE, tFALL (10/90% RF) tON, tOFF (50% CTL to 10/90% RF)		3 10	

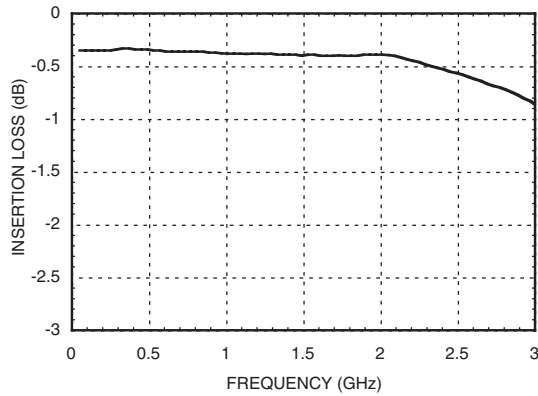
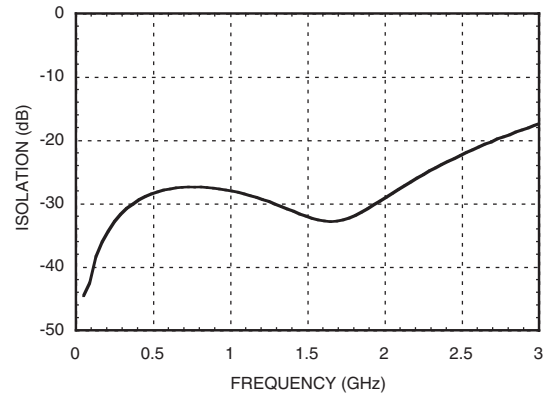
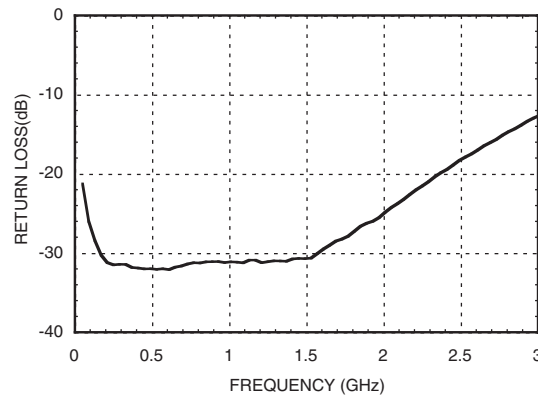
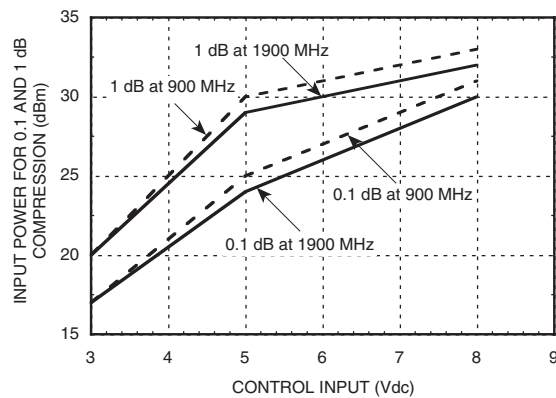
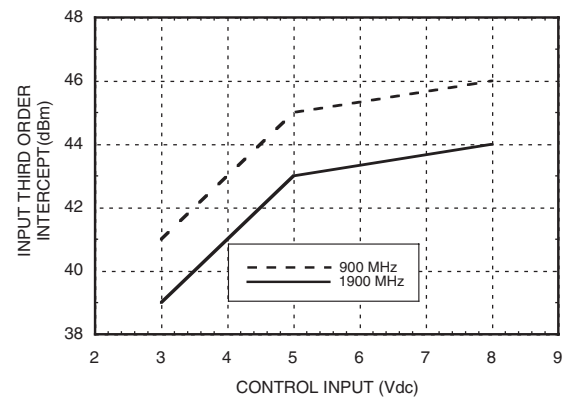
Insertion Loss

Isolation

Return Loss

**Input 0.1 and 1.0 dB
Compression vs. Control Voltage**

**Input Third Order
Intercept Point vs. Control Voltage**



Compression vs. Control Voltage

Control Input (Vdc)	Carrier at 900 MHz		Carrier at 1900 MHz	
	Input Power for 0.1 dB Compression (dBm)	Input Power for 1.0 dB Compression (dBm)	Input Power for 0.1 dB Compression (dBm)	Input Power for 1.0 dB Compression (dBm)
+3	17	20	17	20
+5	25	30	24	29
+8	31	33	30	32

Caution: Do not operate in 1dB compression at power levels above +31 dBm (Vctl = +5 Vdc) and do not "hot switch" power levels greater than +20 dBm (Vctl = +5Vdc).

DC blocks are required at ports RFC, RF1 and RF2.

Distortion vs. Control Voltage

Control Input (Vdc)	Third Order Intercept (dBm) +7 dBm Each Tone	
	900 MHz	1900 MHz
+3	41	39
+5	45	43
+8	46	44

Truth Table

*Control Input Voltage Tolerances are ± 0.2 Vdc.

Control Input*		Control Current		Signal Path	
A (Vdc)	B (Vdc)	Ia (μ A)	Ib (μ A)	RF to RF1	RF to RF2
0	+3	-10	10	ON	OFF
+3	0	10	-10	OFF	ON
0	+5	-55	55	ON	OFF
+5	0	55	-55	OFF	ON
0	+7	-210	210	ON	OFF
+7	0	210	-210	OFF	ON
0	+8	-280	280	ON	OFF
+8	0	280	-280	OFF	ON

Absolute Maximum Ratings

Control Voltage Range (A & B)	-0.2 to +12 Vdc
Storage Temperature	-65 to +150 °C
Operating Temperature	-40 to +85 °C
ESD Sensitivity (HBM)	Class 1A



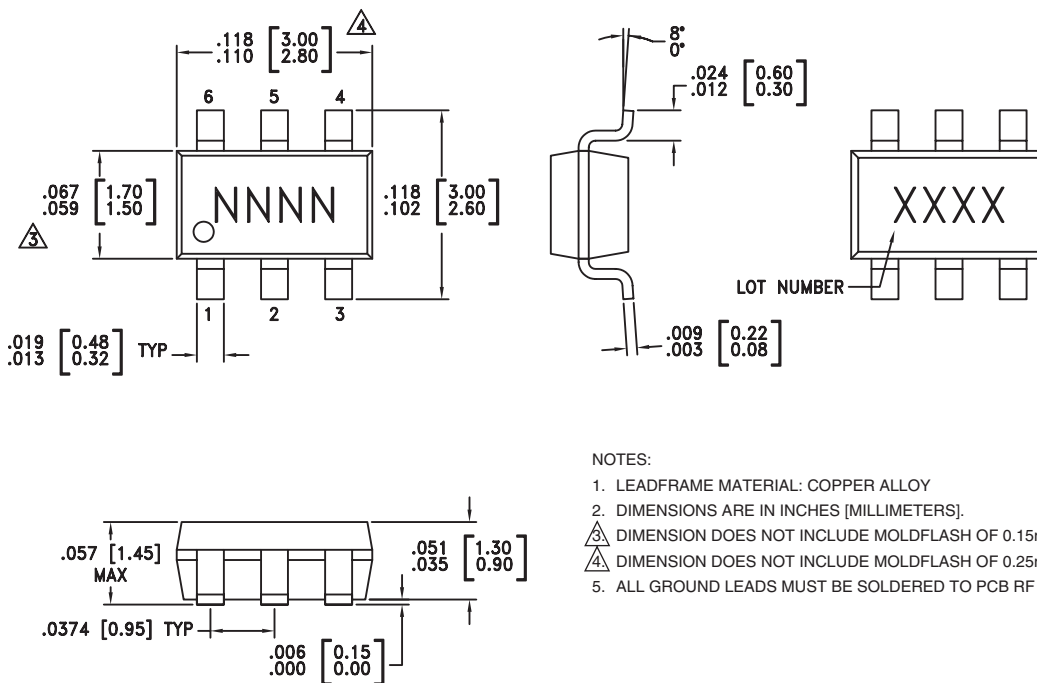

ELECTROSTATIC SENSITIVE DEVICE
OBSERVE HANDLING PRECAUTIONS

Outline Drawing



NOTES:

- LEADFRAME MATERIAL: COPPER ALLOY
- DIMENSIONS ARE IN INCHES [MILLIMETERS].
-  DIMENSION DOES NOT INCLUDE MOLDFLASH OF 0.15mm PER SIDE.
-  DIMENSION DOES NOT INCLUDE MOLDFLASH OF 0.25mm PER SIDE.
- ALL GROUND LEADS MUST BE SOLDERED TO PCB RF GROUND.

Package Information

Part Number	Package Body Material	Lead Finish	MSL Rating	Package Marking ^[3]
HMC197	Low Stress Injection Molded Plastic	Sn/Pb Solder	MSL1 ^[1]	H197 XXXX
HMC197E	RoHS-compliant Low Stress Injection Molded Plastic	100% matte Sn	MSL1 ^[2]	197E XXXX

[1] Max peak reflow temperature of 235 °C

[2] Max peak reflow temperature of 260 °C

[3] 4-Digit lot number XXXX

Typical Application Circuit

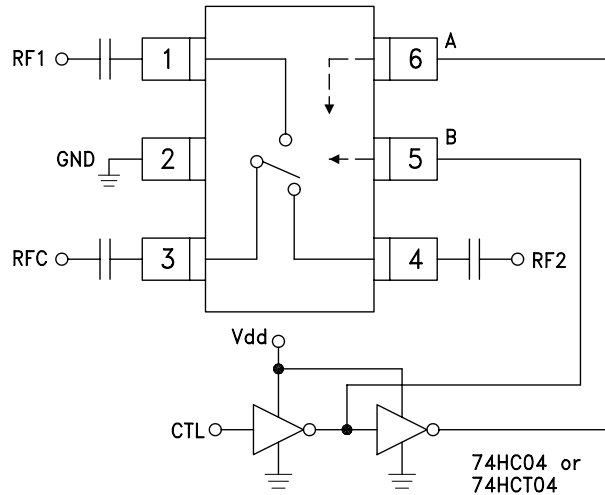

Notes:

1. Set logic gate and switch Vdd = +3V to +5V and use HCT series logic to provide a TTL driver interface.
2. Control inputs A/B can be driven directly with CMOS logic (HC) with Vdd of 5 to 8 Volts applied to the CMOS logic gates.
3. DC Blocking capacitors are required for each RF port as shown. Capacitor value determines lowest frequency of operation.
4. Highest RF signal power capability is achieved with Vdd = +8V and A/B set to 0/+8V.

Evaluation Circuit Board

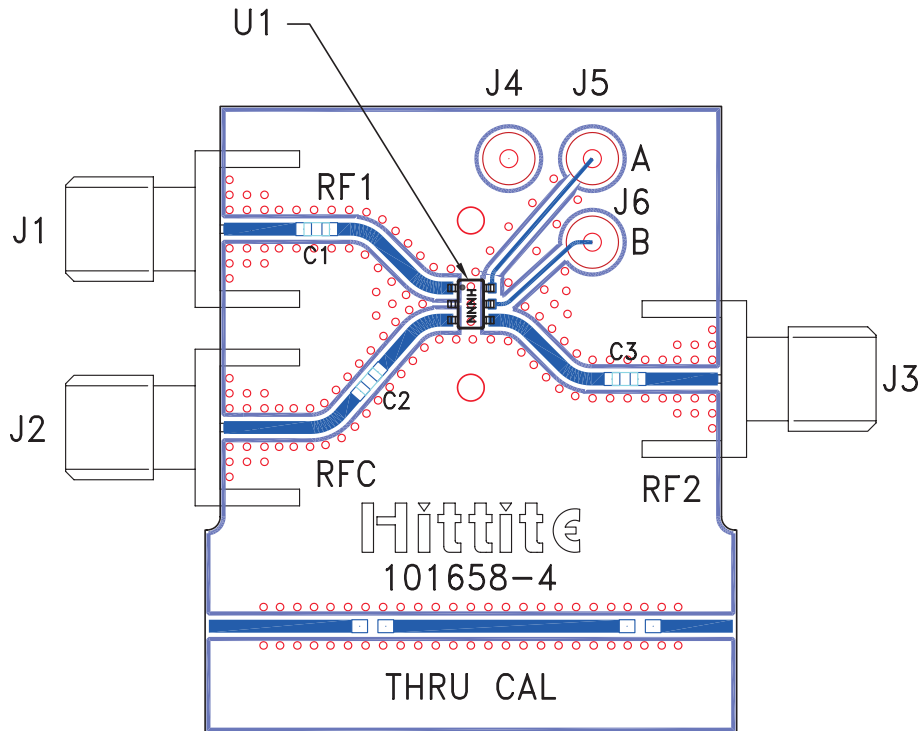

List of Materials for Evaluation PCB 101674 [1]

Item	Description
J1 - J3	PCB Mount SMA RF Connector
J4 - J6	DC Pin
C1 - C3	330 pF capacitor, 0603 Pkg.
U1	HMC197 / HMC197E SPDT Switch
PCB [2]	101658 Evaluation PCB

[1] Reference this number when ordering complete evaluation PCB

[2] Circuit Board Material: Rogers 4350

The circuit board used in the final application should be generated with proper RF circuit design techniques. Signal lines at the RF port should have 50 ohm impedance and the package ground leads and package bottom should be connected directly to the ground plane similar to that shown above. The evaluation circuit board shown above is available from Hittite Microwave Corporation upon request.