

NCP360

USB Positive Overvoltage Protection Controller with Internal PMOS FET and Status FLAG

NCP360 is able to disconnect the systems from its output pin in case wrong VBUS operating conditions is detected. The system is positive over-voltage protected up to +20 V.

Thanks to this device using internal PMOS FET, no external device is necessary, reducing the system cost and the PCB area of the application board.

NCP360 is able to instantaneously disconnect the output from the input if the input voltage exceeds the overvoltage threshold (OVLO).

NCP360 provides a negative going flag ($\overline{\text{FLAG}}$) output, which alerts the system that a fault has occurred.

In addition, the device has ESD-protected input (15 kV Air) when bypassed with a 1 μF or larger capacitor.

Features

- Very Fast Protection, Up to 20 V, with 25 μA Current Consumption
- On-chip PMOS Transistor
- Overvoltage Lockout (OVLO)
- Undervoltage Lockout (UVLO)
- Alert $\overline{\text{FLAG}}$ Output
- $\overline{\text{EN}}$ Enable Pin
- Thermal Shutdown
- Compliance to IEC61000-4-2 (Level 4)
 - 8 kV (Contact)
 - 15 kV (Air)
- ESD Ratings: Machine Model = B
Human Body Model = 3
- 6 Lead UDFN 2x2 mm Package
- 5 Lead TSOP 3x3 mm Package
- These are Pb-Free Devices

Applications

- USB Devices
- Mobile Phones
- Peripheral
- Personal Digital Applications
- MP3 Players



ON Semiconductor®

<http://onsemi.com>

MARKING DIAGRAMS



UDFN6
TBD SUFFIX
CASE 517AB



M = Date Code

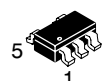

TSOP-5
TBD SUFFIX
CASE 483

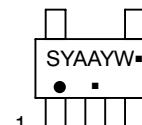

A = Assembly Location

Y = Year

W = Work Week

▪ = Pb-Free Package

(Note: Microdot may be in either location)

ORDERING INFORMATION

Device	Package	Shipping†
NCP360MUTBG	UDFN6 (Pb-Free)	3000/Tape & Reel
NCP360MUTXG	UDFN6 (Pb-Free)	10000/Tape & Reel
NCP360SNT1G	TSOP-5 (Pb-Free)	3000/Tape & Reel
NCP360SNT3G	TSOP-5 (Pb-Free)	10000/Tape & Reel

†For information on tape and reel specifications, including part orientation and tape sizes, please refer to our Tape and Reel Packaging Specification Brochure, BRD8011/D.

NCP360

PIN CONNECTIONS

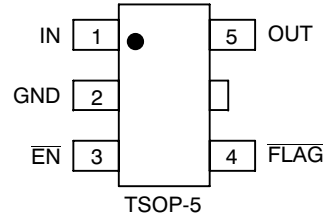
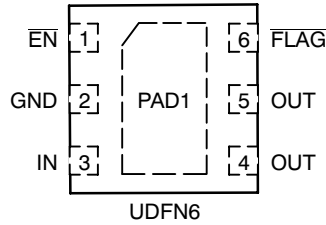

(Top Views)

PIN FUNCTION DESCRIPTION (UDFN6 Package)

Pin No.	Name	Type	Description
1	$\overline{\text{EN}}$	INPUT	Enable Pin. The device enters in shutdown mode when this pin is tied to a high level. In this case the output is disconnected from the input. To allow normal functionality, the $\overline{\text{EN}}$ pin shall be connected to GND to a pull down or to a I/O pin. This pin does not have an impact on the fault detection.
2	GND	POWER	Ground
3	IN	POWER	Input Voltage Pin. This pin is connected to the VBUS. A 1 μF low ESR ceramic capacitor, or larger, must be connected between this pin and GND.
4, 5	OUT	OUTPUT	Output Voltage Pin. The output is disconnected from the VBUS power supply when the input voltage is above OVLO threshold or below UVLO threshold. A 1 μF capacitor must be connected to these pins. The two OUT pins must be hardwired to common supply.
6	$\overline{\text{FLAG}}$	OUTPUT	Fault Indication Pin. This pin allows an external system to detect a fault on VBUS pin. The $\overline{\text{FLAG}}$ pin goes low when input voltage exceeds OVLO threshold. Since the $\overline{\text{FLAG}}$ pin is open drain functionality, an external pull up resistor to V_{CC} must be added.
-	PAD1	POWER	Exposed Pad. Can be connected to GND or isolated plane. Must be used to thermal dissipation.

PIN FUNCTION DESCRIPTION (TSOP-5 Package)

Pin No.	Name	Type	Description
1	IN	POWER	Input Voltage Pin. This pin is connected to the VBUS. A 1 μF low ESR ceramic capacitor, or larger, must be connected between this pin and GND.
2	GND	POWER	Ground
3	$\overline{\text{EN}}$	INPUT	Enable Pin. The device enters in shutdown mode when this pin is tied to a high level. In this case the output is disconnected from the input. To allow normal functionality, the $\overline{\text{EN}}$ pin shall be connected to GND to a pull down or to a I/O pin. This pin does not have an impact on the fault detection.
4	$\overline{\text{FLAG}}$	OUTPUT	Fault Indication Pin. This pin allows an external system to detect a fault on VBUS pin. The $\overline{\text{FLAG}}$ pin goes low when input voltage exceeds OVLO threshold. Since the $\overline{\text{FLAG}}$ pin is open drain functionality, an external pull up resistor to V_{CC} must be added.
5	OUT	OUTPUT	Output Voltage Pin. The output is disconnected from the VBUS power supply when the input voltage is above OVLO threshold or below UVLO threshold. A 1 μF capacitor must be connected to this pin.

NCP360

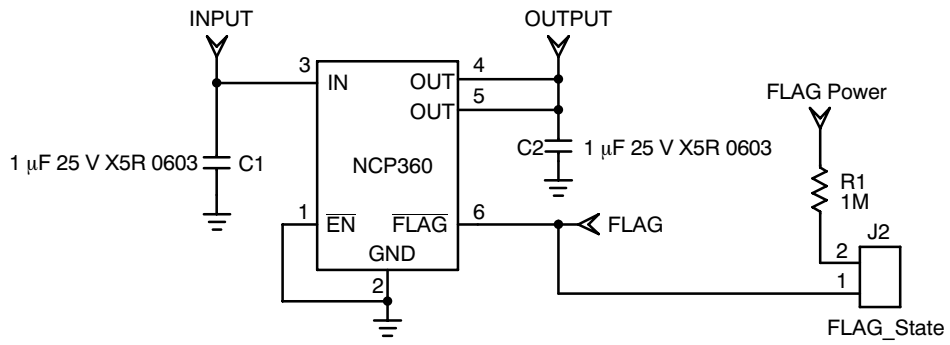

Figure 1. Typical Application Circuit (UDFN Pinout)

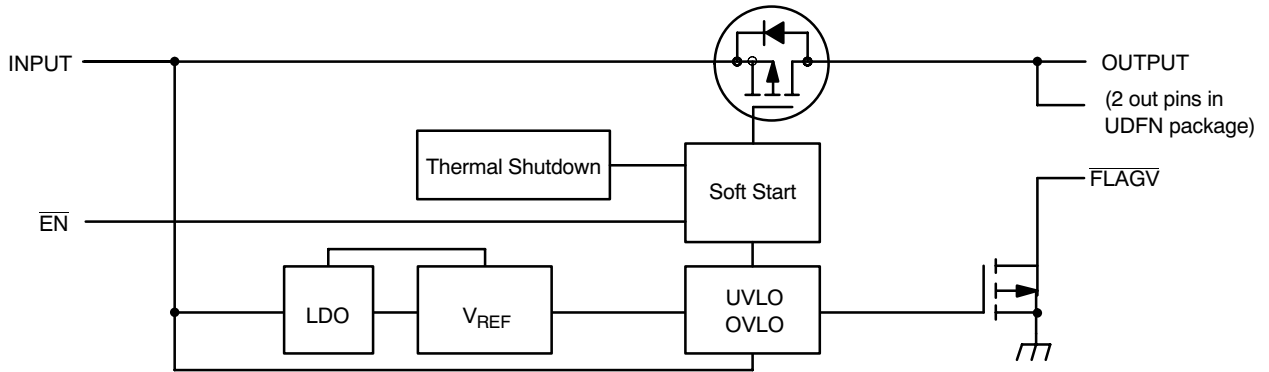

Figure 2. Functional Block Diagram

NCP360

MAXIMUM RATINGS

Rating	Symbol	Value	Unit
Minimum Voltage (IN to GND)	$V_{min_{in}}$	-0.3	V
Minimum Voltage (All others to GND)	V_{min}	-0.3	V
Maximum Voltage (IN to GND)	$V_{max_{in}}$	21	V
Maximum Voltage (All others to GND)	V_{max}	7.0	V
Maximum Current from Vin to Vout (PMOS)	I_{max}	600	mA
Thermal Resistance, Junction-to-Air (Note 1)	$R_{\theta JA}$	305 260	°C/W
	TSOP-5 UDFN		
Operating Ambient Temperature Range	T_A	-40 to +85	°C
Storage Temperature Range	T_{stg}	-65 to +150	°C
Junction Operating Temperature	T_J	150	°C
ESD Withstand Voltage (IEC 61000-4-2) Human Body Model (HBM), Model = 2 (Note 2) Machine Model (MM) Model = B (Note 3)	V_{esd}	15 Air, 8.0 Contact 2000 200	kV V V
Moisture Sensitivity	MSL	Level 1	-

Stresses exceeding Maximum Ratings may damage the device. Maximum Ratings are stress ratings only. Functional operation above the Recommended Operating Conditions is not implied. Extended exposure to stresses above the Recommended Operating Conditions may affect device reliability.

- $R_{\theta JA}$ is highly dependent on the PCB heat sink area (connected to PAD1, UDFN). See PCB Recommendations.
- Human Body Model, 100 pF discharged through a 1.5 k Ω resistor following specification JESD22/A114.
- Machine Model, 200 pF discharged through all pins following specification JESD22/A115.
- Compliant with JEDEC Latch-up Test, up to maximum voltage range.

ELECTRICAL CHARACTERISTICS

(Min/Max limits values (-40°C < T_A < +85°C) and $V_{in} = +5.0$ V. Typical values are $T_A = +25^\circ\text{C}$, unless otherwise noted.)

Characteristic	Symbol	Conditions	Min	Typ	Max	Unit
Input Voltage Range	V_{in}		1.2		20	V
Undervoltage Lockout Threshold	UVLO	V_{in} falls down UVLO threshold	2.85	3.0	3.15	V
UVLO Hysteresis	UVLO _{hyst}		50	70	90	mV
Overvoltage Lockout Threshold	OVLO	V_{in} rises up OVLO threshold	5.43	5.675	5.9	V
Overvoltage Lockout Hysteresis	OVLO _{hyst}		50	100	125	mV
V_{in} versus V_{out} Dropout	V_{drop}	$V_{in} = 5$ V, $I_{charge} = 500$ mA		105	200	mV
Supply Quiescent Current	I_{dd}	No Load, $V_{in} = 5.25$ V		24	35	μA
OVLO Supply Current	$I_{dd_{uvlo}}$	$V_{in} = 7$ V		50	85	μA
Output Off State Current	I_{std}	$V_{in} = 5.25$ V, EN = 1.2 V		26	37	μA
FLAG Output Low Voltage	$V_{ol_{flag}}$	$V_{in} > OVLO$, Sink 1 mA on $\overline{\text{FLAG}}$ pin			400	mV
FLAG Leakage Current	FLAG _{leak}	$\overline{\text{FLAG}}$ level = 5 V		5.0		nA
$\overline{\text{EN}}$ Voltage High	V_{ih}	V_{in} from 3.3 V to 5.25 V	1.2			V
$\overline{\text{EN}}$ Voltage Low	V_{ol}	V_{in} from 3.3 V to 5.25 V			0.4	V
EN Leakage Current	EN _{leak}	EN = 5.5 V or GND		170		nA

TIMINGS

Start Up Delay	t_{on}	From $V_{in} > UVLO$ to $V_{out} = 0.8 \times V_{in}$, See Fig 3		4.0	15	ms
FLAG going up Delay	t_{start}	From $V_{in} > UVLO$ to $\overline{\text{FLAG}} = 1.2$ V, See Fig 3		3.0		μs
Output Turn Off Time	t_{off}	From $V_{in} > OVLO$ to $V_{out} \leq 0.3$ V, See Fig 4 V_{in} increasing from 5 V to 8 V at 1 V/ μs . No output capacitor.		0.8	1.5	μs
Alert Delay	t_{stop}	From $V_{in} > OVLO$ to $\overline{\text{FLAG}} \leq 0.4$ V, See Fig 4 V_{in} increasing from 5 V to 8 V at 3 V/ μs		1.0	2.0	μs
Disable Time	t_{dis}	From $\overline{\text{EN}} 0.4$ to 1.2V to $V_{out} \leq 0.3$ V, See Fig 5 $V_{in} = 4.75$ V. No output capacitor.		2.0		μs
Thermal Shutdown Temperature	T_{sd}			150		°C
Thermal Shutdown Hysteresis	$T_{sd_{hyst}}$			30		°C

NOTE: Thermal Shutdown parameter has been fully characterized and guaranteed by design.

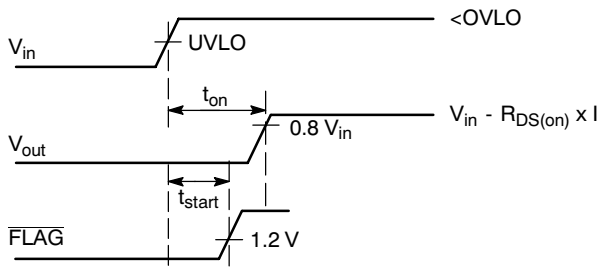

Figure 3. Start Up Sequence

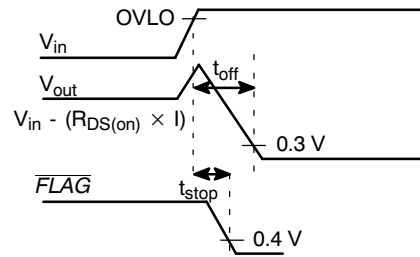

Figure 4. Shutdown on Over Voltage Detection

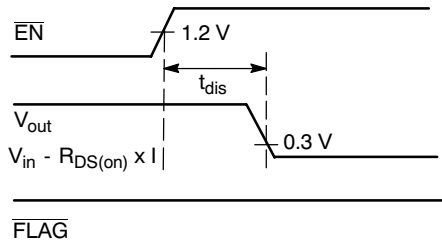

Figure 5. Disable on $\overline{EN} = 1$

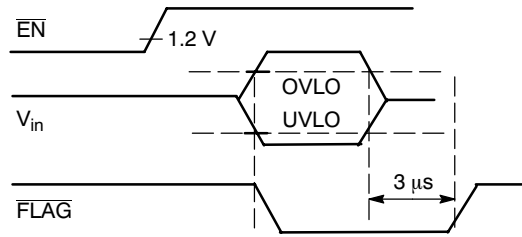

Figure 6. \overline{FLAG} Response with $\overline{EN} = 1$

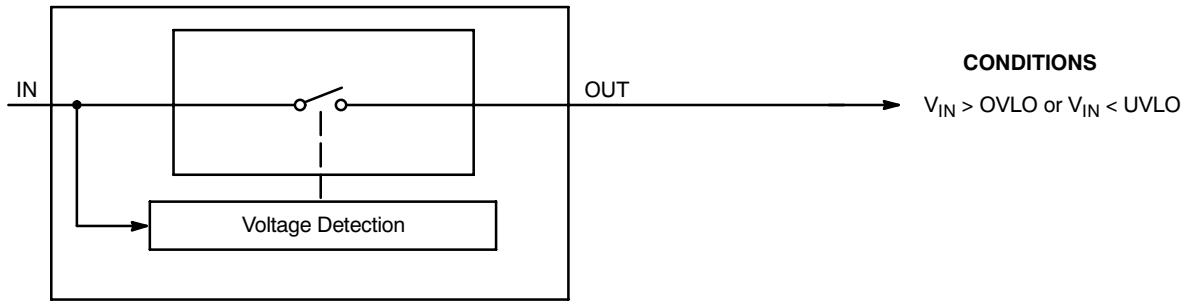

Figure 7.

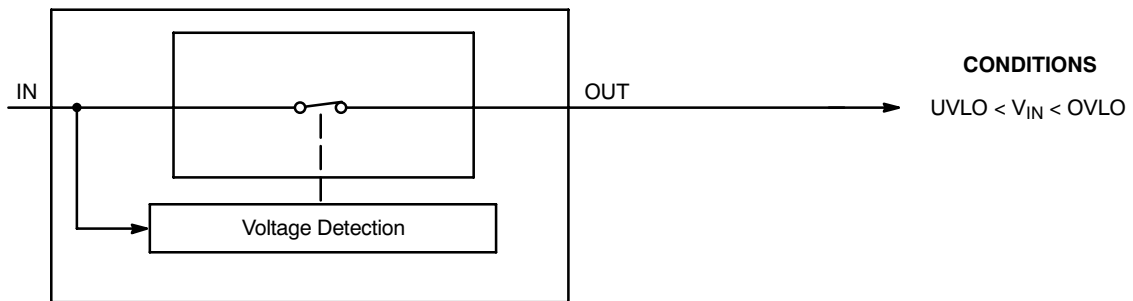

Figure 8.

TYPICAL OPERATING CHARACTERISTICS

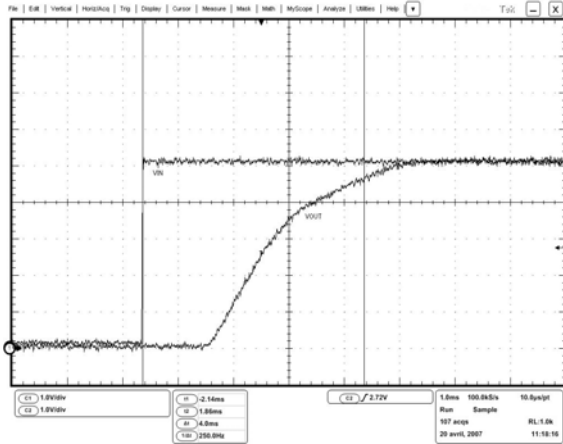

Figure 9. Startup
 $V_{in} = \text{Ch1}$, $V_{out} = \text{Ch3}$

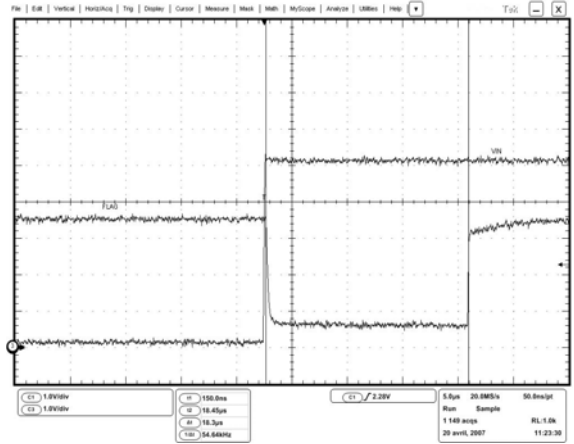

Figure 10. FLAG Going Up Delay
 $V_{out} = \text{Ch3}$, FLAG = Ch2

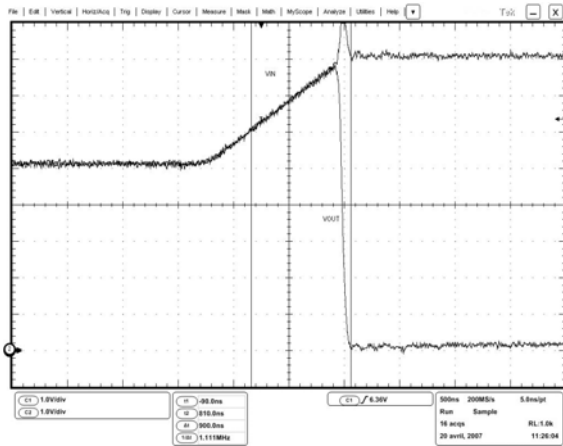

Figure 11. Output Turn Off Time
 $V_{in} = \text{Ch1}$, $V_{out} = \text{Ch2}$

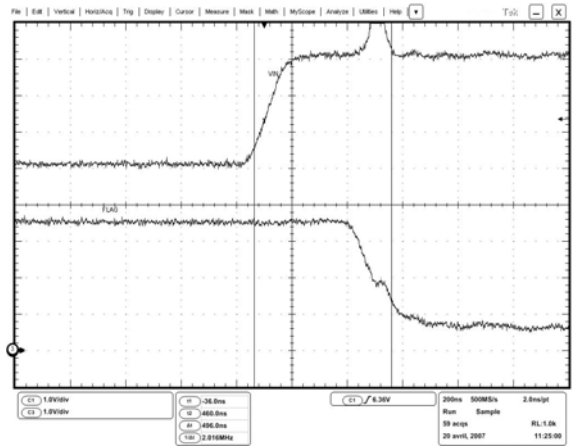

Figure 12. Alert Delay
 $V_{out} = \text{Ch1}$, FLAG = Ch3

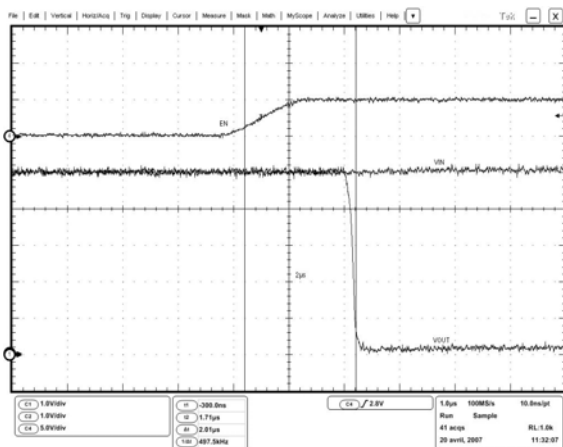

Figure 13. Disable Time
 $\text{EN} = \text{Ch1}$, $V_{out} = \text{Ch2}$, FLAG = Ch3

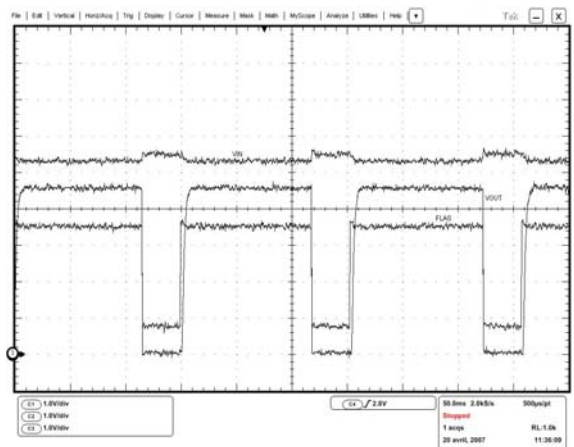

Figure 14. Thermal Shutdown
 $V_{in} = \text{Ch1}$, $V_{out} = \text{Ch2}$, FLAG = Ch3

NCP360

TYPICAL OPERATING CHARACTERISTICS

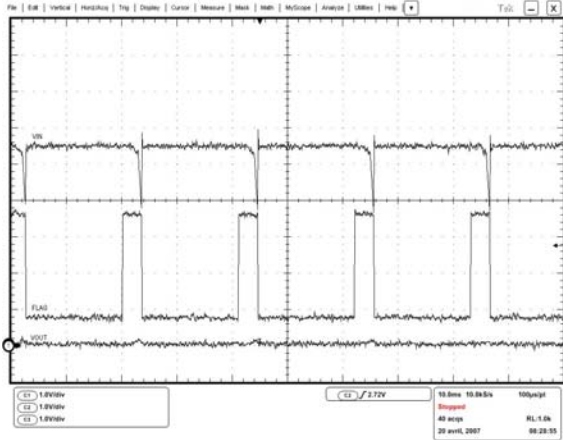

Figure 15. Direct Output Short Circuit

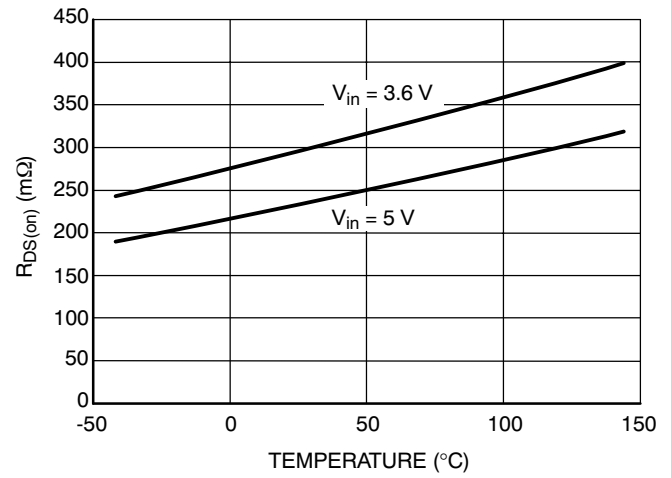

Figure 16. R_{DS(on)} vs. Temperature
(Load = 500 mA)

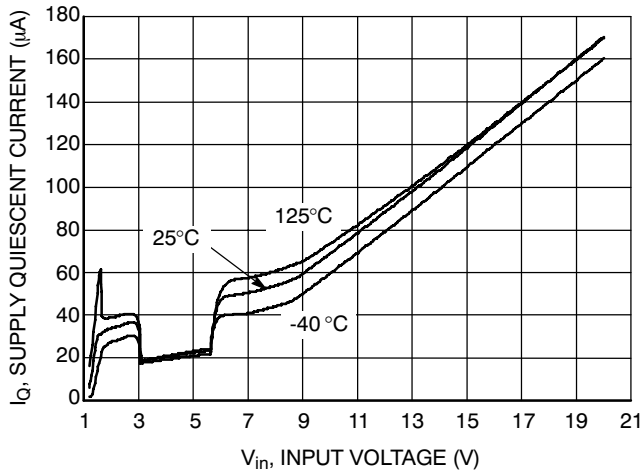

Figure 17. Supply Quiescent Current vs. V_{in}

In Operation

NCP360 provides overvoltage protection for positive voltage, up to 20 V. A PMOS FET protects the systems (i.e.: VBUS) connected on the V_{out} pin, against positive over-voltage. The Output follows the VBUS level until OVLO threshold is overtaken.

Undervoltage Lockout (UVLO)

To ensure proper operation under any conditions, the device has a built-in undervoltage lock out (UVLO) circuit. During V_{in} positive going slope, the output remains disconnected from input until V_{in} voltage is above 3.2 V nominal. The FLAGV output is pulled to low as long as V_{in} does not reach UVLO threshold. This circuit has a 50 mV hysteresis to provide noise immunity to transient condition.

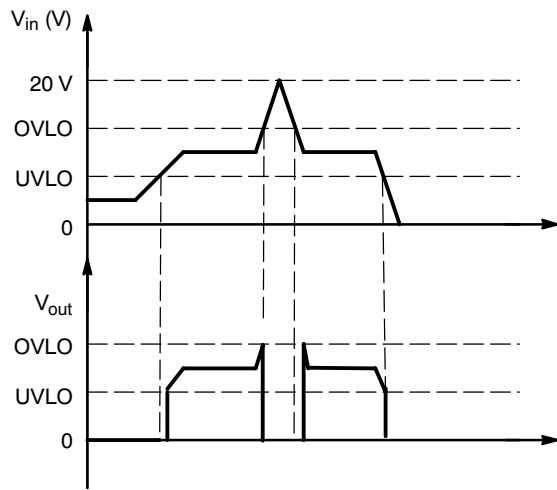

Figure 18. Output Characteristic vs. V_{in}

Overvoltage Lockout (OVLO)

To protect connected systems on V_{out} pin from overvoltage, the device has a built-in overvoltage lock out (OVLO) circuit. During overvoltage condition, the output remains disabled until the input voltage exceeds OVLO - Hysteresis.

FLAG output is tied to low until V_{in} is higher than OVLO. This circuit has a 100 mV hysteresis to provide noise immunity to transient conditions.

FLAG Output

NCP360 provides a FLAG output, which alerts external systems that a fault has occurred.

This pin is tied to low as soon the OVLO threshold is exceeded. When V_{in} level recovers normal condition, FLAG is held high. The pin is an open drain output, thus a pull up resistor (typically 1 MΩ- Minimum 10 kΩ) must be provided to V_{battery}. FLAG pin is an open drain output.

EN Input

To enable normal operation, the EN pin shall be forced to low or connected to ground. A high level on the pin disconnects OUT pin from IN pin. EN does not overdrive an OVLO or UVLO fault.

Internal PMOS FET

NCP360 includes an internal PMOS FET to protect the systems, connected on OUT pin, from positive overvoltage. Regarding electrical characteristics, the R_{DSon}, during normal operation, will create low losses on V_{out} pin, characterized by V_{in} versus V_{out} dropout. (See Figure 16).

ESD Tests

NCP360 fully support the IEC61000-4-2, level 4 (Input pin, 1 μF mounted on board).

That means, in Air condition, V_{in} has a ±15 kV ESD protected input. In Contact condition, V_{in} has ±8 kV ESD protected input.

Please refer to Fig 19 to see the IEC 61000-4-2 electrostatic discharge waveform.

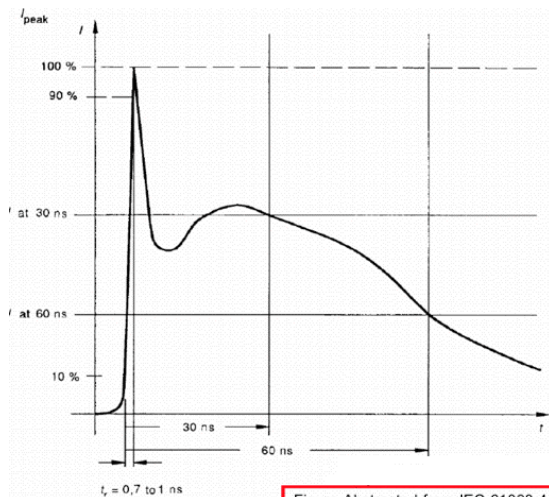

Figure 19.

PCB Recommendations

The NCP360 integrates a 500 mA rated PMOS FET, and the PCB rules must be respected to properly evacuate the heat out of the silicon. The UDFN PAD1 must be connected to ground plane to increase the heat transfer if necessary from an application standpoint. Of course, in any case, this pad shall be not connected to any other potential.

NCP360

PACKAGE DIMENSIONS

UDFN6 2x2, 0.65P
CASE 517AB-01
ISSUE B

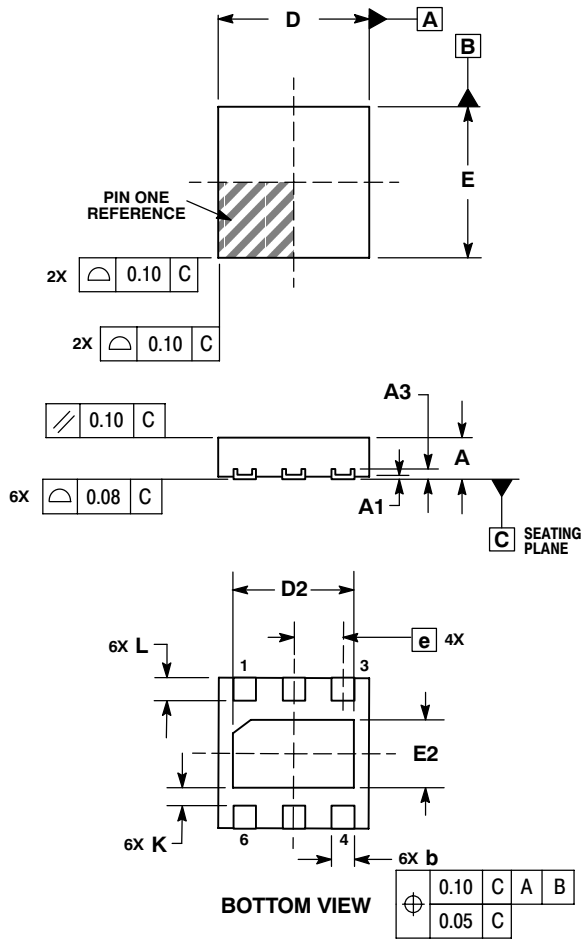

NOTES:

1. DIMENSIONING AND TOLERANCING PER ASME Y14.5M, 1994.
2. CONTROLLING DIMENSION: MILLIMETERS.
3. COPLANARITY APPLIES TO THE EXPOSED PAD AS WELL AS THE TERMINALS.

DIM	MILLIMETERS	
	MIN	MAX
A	0.45	0.55
A1	0.00	0.05
A3	0.127 REF	
b	0.25	0.35
D	2.00 BSC	
D2	1.50	1.70
E	2.00 BSC	
E2	0.80	1.00
e	0.65 BSC	
K	0.20	---
L	0.25	0.35

SOLDERING FOOTPRINT*

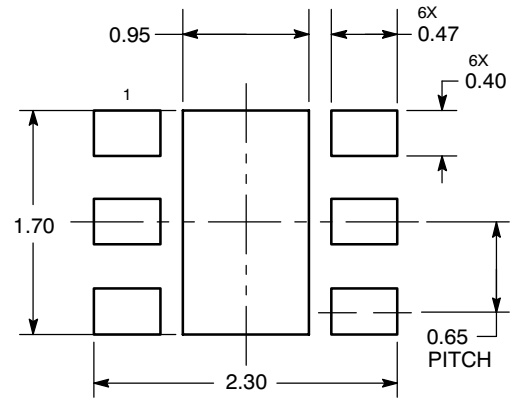

*For additional information on our Pb-Free strategy and soldering details, please download the ON Semiconductor Soldering and Mounting Techniques Reference Manual, SOLDERRM/D.

NCP360

PACKAGE DIMENSIONS

TSOP-5 CASE 483-02 ISSUE G

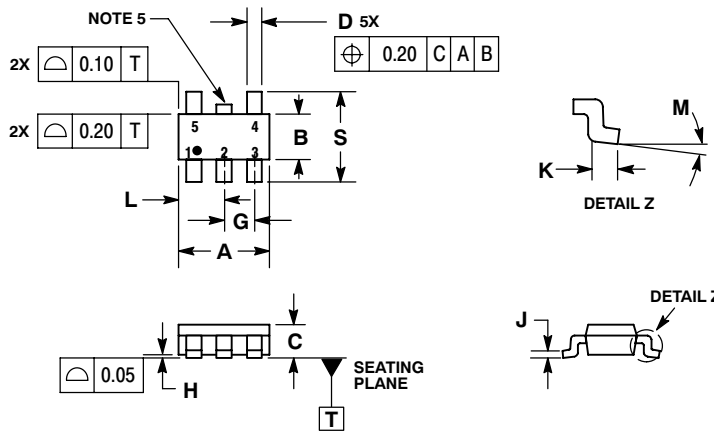

NOTES:

1. DIMENSIONING AND TOLERANCING PER ASME Y14.5M, 1994.
2. CONTROLLING DIMENSION: MILLIMETERS.
3. MAXIMUM LEAD THICKNESS INCLUDES LEAD FINISH THICKNESS. MINIMUM LEAD THICKNESS IS THE MINIMUM THICKNESS OF BASE MATERIAL.
4. DIMENSIONS A AND B DO NOT INCLUDE MOLD FLASH, PROTRUSIONS, OR GATE BURRS.
5. OPTIONAL CONSTRUCTION: AN ADDITIONAL TRIMMED LEAD IS ALLOWED IN THIS LOCATION. TRIMMED LEAD NOT TO EXTEND MORE THAN 0.2 FROM BODY.

MILLIMETERS		
DIM	MIN	MAX
A	3.00 BSC	
B	1.50 BSC	
C	0.90	1.10
D	0.25	0.50
G	0.95 BSC	
H	0.01	0.10
J	0.10	0.26
K	0.20	0.60
L	1.25	1.55
M	0°	10°
S	2.50	3.00

SOLDERING FOOTPRINT*

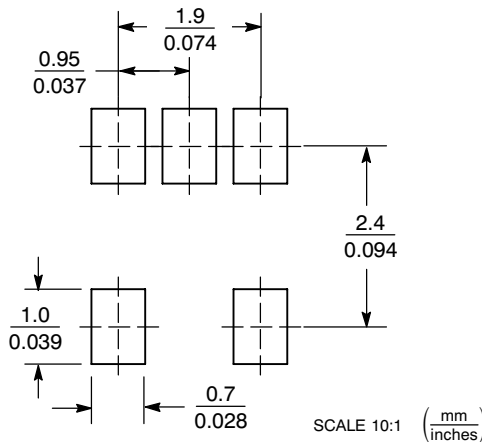

*For additional information on our Pb-Free strategy and soldering details, please download the ON Semiconductor Soldering and Mounting Techniques Reference Manual, SOLDERRM/D.

ON Semiconductor and are registered trademarks of Semiconductor Components Industries, LLC (SCILLC). SCILLC reserves the right to make changes without further notice to any products herein. SCILLC makes no warranty, representation or guarantee regarding the suitability of its products for any particular purpose, nor does SCILLC assume any liability arising out of the application or use of any product or circuit, and specifically disclaims any and all liability, including without limitation special, consequential or incidental damages. "Typical" parameters which may be provided in SCILLC data sheets and/or specifications can and do vary in different applications and actual performance may vary over time. All operating parameters, including "Typicals" must be validated for each customer application by customer's technical experts. SCILLC does not convey any license under its patent rights nor the rights of others. SCILLC products are not designed, intended, or authorized for use as components in systems intended for surgical implant into the body, or other applications intended to support or sustain life, or for any other application in which the failure of the SCILLC product could create a situation where personal injury or death may occur. Should Buyer purchase or use SCILLC products for any such unintended or unauthorized application, Buyer shall indemnify and hold SCILLC and its officers, employees, subsidiaries, affiliates, and distributors harmless against all claims, costs, damages, and expenses, and reasonable attorney fees arising out of, directly or indirectly, any claim of personal injury or death associated with such unintended or unauthorized use, even if such claim alleges that SCILLC was negligent regarding the design or manufacture of the part. SCILLC is an Equal Opportunity/Affirmative Action Employer. This literature is subject to all applicable copyright laws and is not for resale in any manner.

PUBLICATION ORDERING INFORMATION

LITERATURE FULFILLMENT:
Literature Distribution Center for ON Semiconductor
P.O. Box 5163, Denver, Colorado 80217 USA
Phone: 303-675-2175 or 800-344-3860 Toll Free USA/Canada
Fax: 303-675-2176 or 800-344-3867 Toll Free USA/Canada
Email: orderlit@onsemi.com

N. American Technical Support: 800-282-9855 Toll Free
USA/Canada
Europe, Middle East and Africa Technical Support:
Phone: 421 33 790 2910
Japan Customer Focus Center
Phone: 81-3-5773-3850

ON Semiconductor Website: www.onsemi.com
Order Literature: <http://www.onsemi.com/orderlit>

For additional information, please contact your local Sales Representative