

CMOS 8-Bit Microcontroller TMP88PS38NG/FG

The TMP88PS38 is the high-speed and high performance 8-bit signal chip microcomputers which built in a program storage area (64 Kbytes), an OSD font storage area (24 Kbytes) and the one-time PROM of vector table storage area (256 bytes). The TMP88PS38 is pin compatible with the TMP88CS38. The operation possible with the TMP88PS38 can be performed by writing programs to PROM. The TMP88PS38 can write and verify in the same way as the TC571000D an EPROM programmer.

Product No.	OTP	RAM	Package	Adaptor Socket
TMP88PS38NG	64 Kbytes (256 bytes)	2 Kbytes	P-SDIP42-600-1.78	BM11174A
TMP88PS38FG	24 Kbytes		P-QFP44-1414-0.80K	BM11175A

030619EBP1

- The information contained herein is subject to change without notice.
- The information contained herein is presented only as a guide for the applications of our products. No responsibility is assumed by TOSHIBA for any infringements of patents or other rights of the third parties which may result from its use. No license is granted by implication or otherwise under any patent or patent rights of TOSHIBA or others.
- TOSHIBA is continually working to improve the quality and reliability of its products. Nevertheless, semiconductor devices in general can malfunction or fail due to their inherent electrical sensitivity and vulnerability to physical stress. It is the responsibility of the buyer, when utilizing TOSHIBA products, to comply with the standards of safety in making a safe design for the entire system, and to avoid situations in which a malfunction or failure of such TOSHIBA products could cause loss of human life, bodily injury or damage to property.
In developing your designs, please ensure that TOSHIBA products are used within specified operating ranges as set forth in the most recent TOSHIBA products specifications. Also, please keep in mind the precautions and conditions set forth in the "Handling Guide for Semiconductor Devices," or "TOSHIBA Semiconductor Reliability Handbook" etc..
- The TOSHIBA products listed in this document are intended for usage in general electronics applications (computer, personal equipment, office equipment, measuring equipment, industrial robotics, domestic appliances, etc.). These TOSHIBA products are neither intended nor warranted for usage in equipment that requires extraordinarily high quality and/or reliability or a malfunction or failure of which may cause loss of human life or bodily injury ("Unintended Usage"). Unintended Usage include atomic energy control instruments, airplane or spaceship instruments, transportation instruments, traffic signal instruments, combustion control instruments, medical instruments, all types of safety devices, etc.. Unintended Usage of TOSHIBA products listed in this document shall be made at the customer's own risk.
- The products described in this document are subject to the foreign exchange and foreign trade laws.
- TOSHIBA products should not be embedded to the downstream products which are prohibited to be produced and sold, under any law and regulations.
- For a discussion of how the reliability of microcontrollers can be predicted, please refer to Section 1.3 of the chapter entitled Quality and Reliability Assurance/Handling Precautions.



Purchase of TOSHIBA I²C components conveys a license under the Philips I²C Patent Rights to use these components in an I²C system, provided that the system conforms to the I²C Standard Specification as defined by Philips.

Pin Assignments

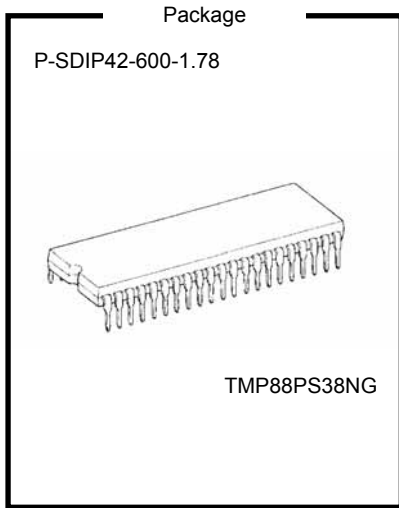

P-SDIP42-600-1.78

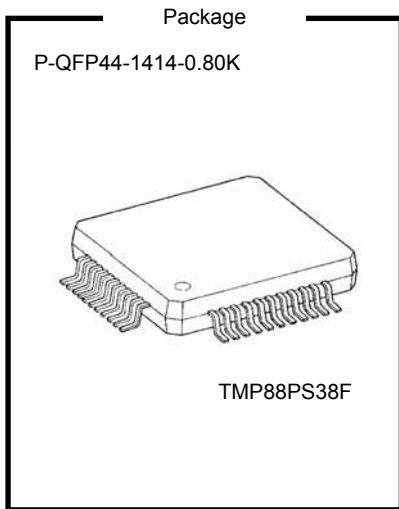
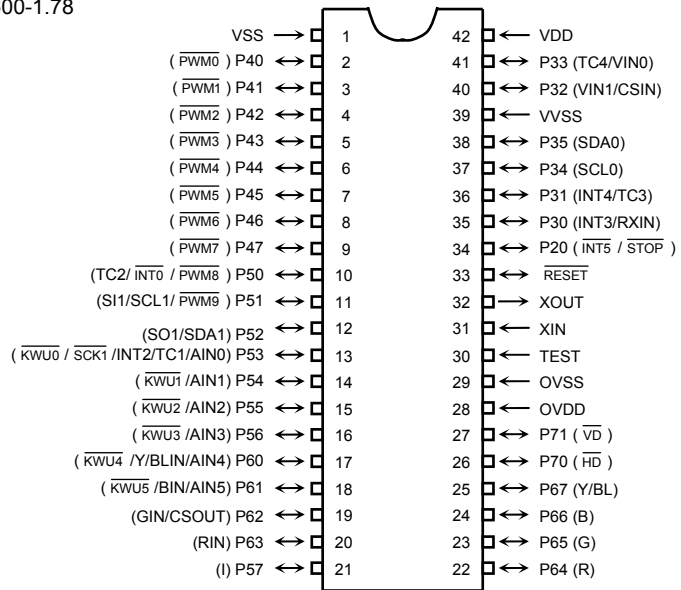

P-QFP44-1414-0.80K

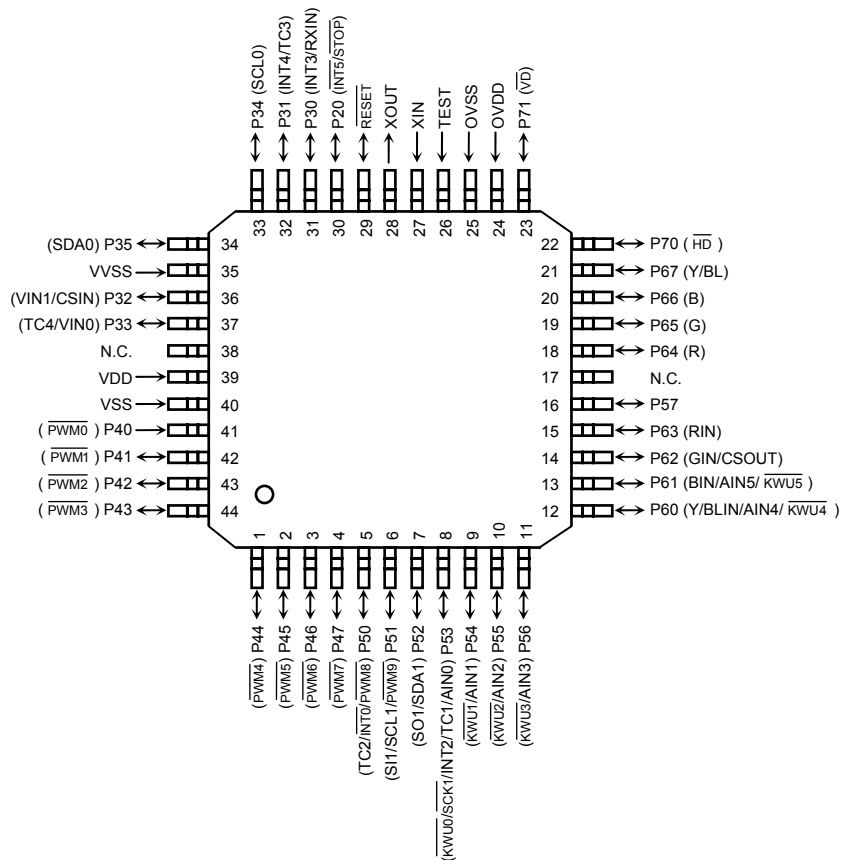

Operational Description

The configuration and function of the TMP88PS38 are the same as those of the TMP88CS38, except in that a one-time PROM is used instead of an on-chip mask ROM.

1. Operation Mode

The TMP88PS38 has two mode: MCU and PROM.

1.1 MCU Mode

The MCU mode is activated by fixing the TEST/VPP pin at low level.
In the MCU mode, operation is the same as with the TMP88CS38.

1.1.1 Program Memory

The TMP88PS38 has a 64 Kbytes (Addresses 04000H to 13EFFFH in the MCU mode, addresses 10000H to 1FEFFFH in the PROM mode) of program storage area, 24 Kbytes (Addresses 20000H to 25FFFFH in the MCU mode, addresses 0A000H to 0FFFFH in the PROM mode) and 256 bytes (Addresses FFF00H to FFFFFH in the MCU mode, addresses 1FF00H to 1FFFFH in the PROM mode) one-time PROM of vector table storage area.

1.1.2 Data Memory

The TMP88PS38 has an on-chip 2-Kbyte data memory (Static RAM).

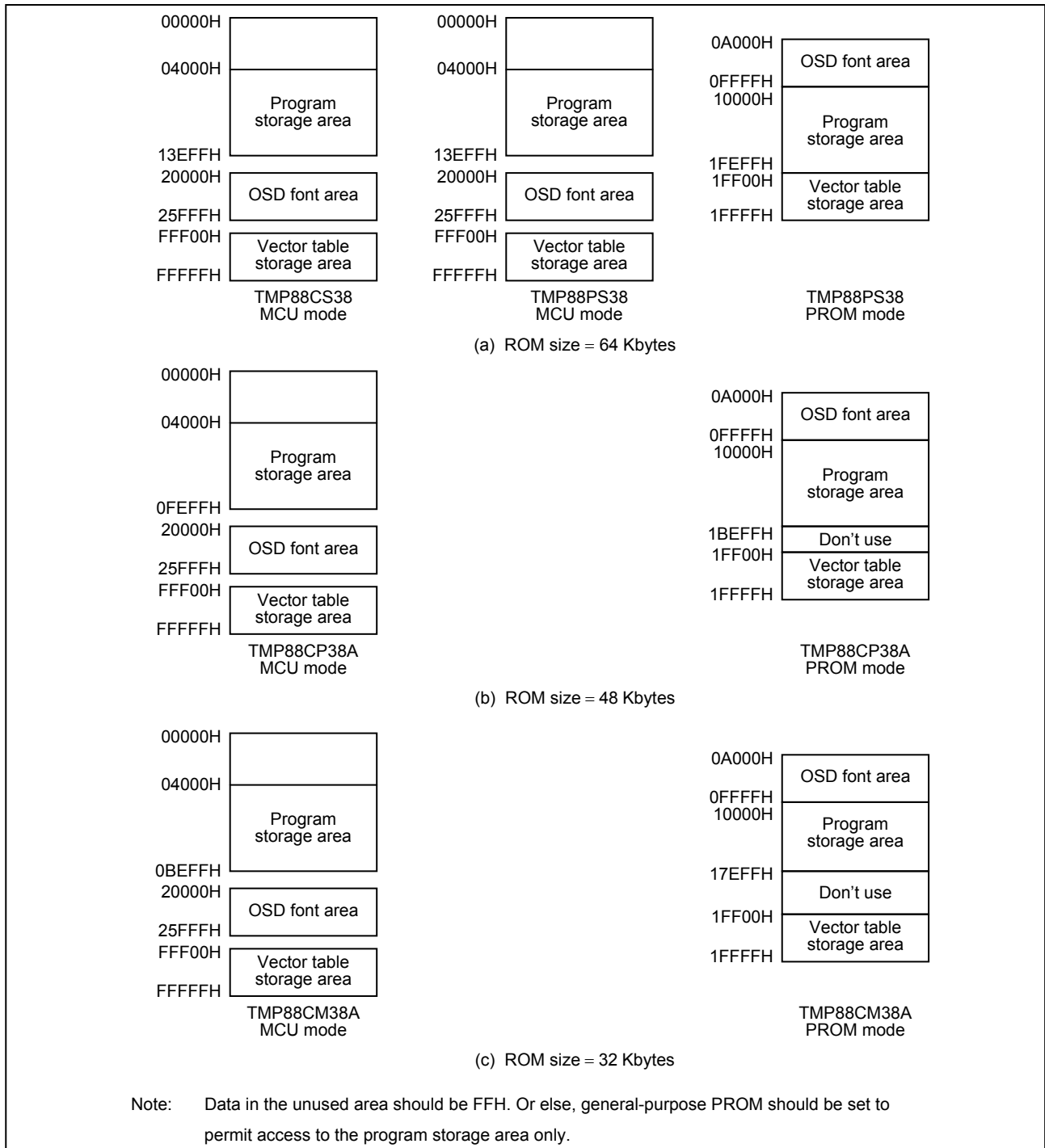

Figure 1.1.1 Program Storage Area

1.1.3 Input/Output Circuit for Pins

(1) Control pins

The TMP88PS38 is identical to the TMP88CS38 and TMP88CM38A/CP38A except that it has a TEST pin without a pull-down resistor.

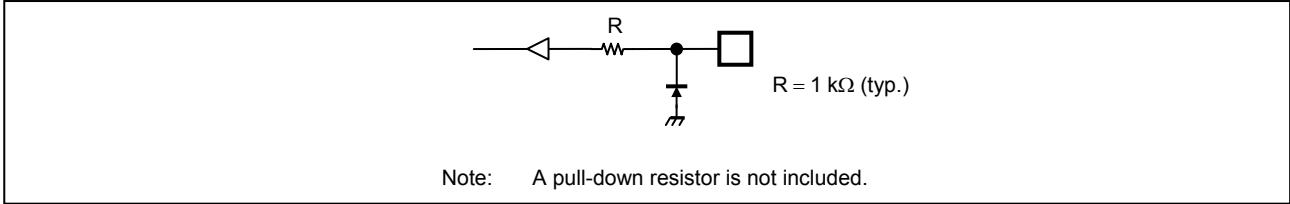

Figure 1.1.2 TEST Pin

(2) I/O ports

The input/output circuit for the TMP88PS38 I/O port is the same as that for the TMP88CS38 and TMP88CM38A/CP38A.

1.2 PROM Mode

The PROM mode is used to write and verify programs with a general-purpose PROM programmer. The high-speed programming mode can be used for program operation.

The TMP88PS38 is not supported an electric signature mode, so the ROM type must be set to TC571000D.

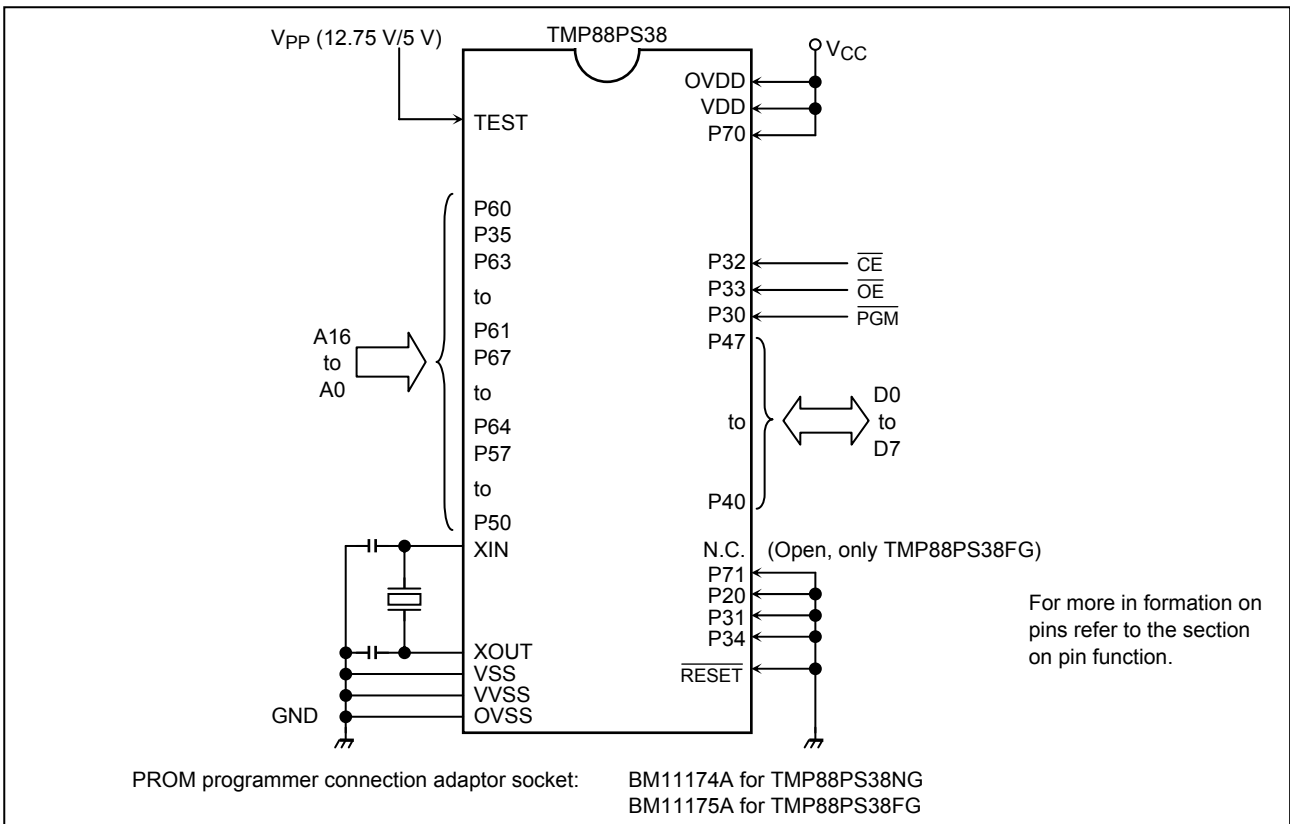

Figure 1.2.1 Setting for PROM Mode

Pin Name (EPROM mode)	Input/Output	Function	Pin Name (MCU mode)
A16	Input	PROM address inputs	P60
A15 to A8			P35, P63 to P61, P67 to P64
A7 to A0			P57 to P50
D7 to D0	I/O	PROM data inputs/outputs	P47 to p40
\overline{CE}	Input	Chip enable signal input (Active low)	P32
\overline{OE}		Output enable signal input (Active low)	P33
\overline{PGM}		Program mode signal input	P30
VPP	Power supply	+12.75 V/5 V (Program supply voltage)	TEST
VCC		+6.25 V/5 V	VDD, OVDD
GND		0 V	VSS, WVSS, OVSS
P70	Input	PROM mode setting pin. Be fixed at high level.	
P71, P20, P31, P34		PROM mode setting pin. Be fixed at low level.	
\overline{RESET}		PROM mode setting pin. Be fixed at low level.	
XIN	Input	Connect an 8 MHz oscillator to stabilize the state.	
XOUT	Output		
N.C.	Open	Open	

PROM programmer connection adaptor socket: BM11174A for TMP88PS38NG
 BM11175A for TMP88PS38FG

1.3 Programming Flowchart (High-speed Programming Mode)

The high-speed programming mode is achieved by applying the program voltage (+12.75 V) to the VPP pin when Vcc = 6.25 V. After the address and input data are stable, the data is programmed by applying a single 0.1ms program pulse to the PGM input. The programmed data is verified. If incorrect, another 0.1ms program pulse is applied. This process should be repeated (up to 25 times) until the program operates correctly. After that, change the address and input data, and program as before. When programming has been completed, the data in all addresses should be verified with Vcc = Vpp = 5 V.

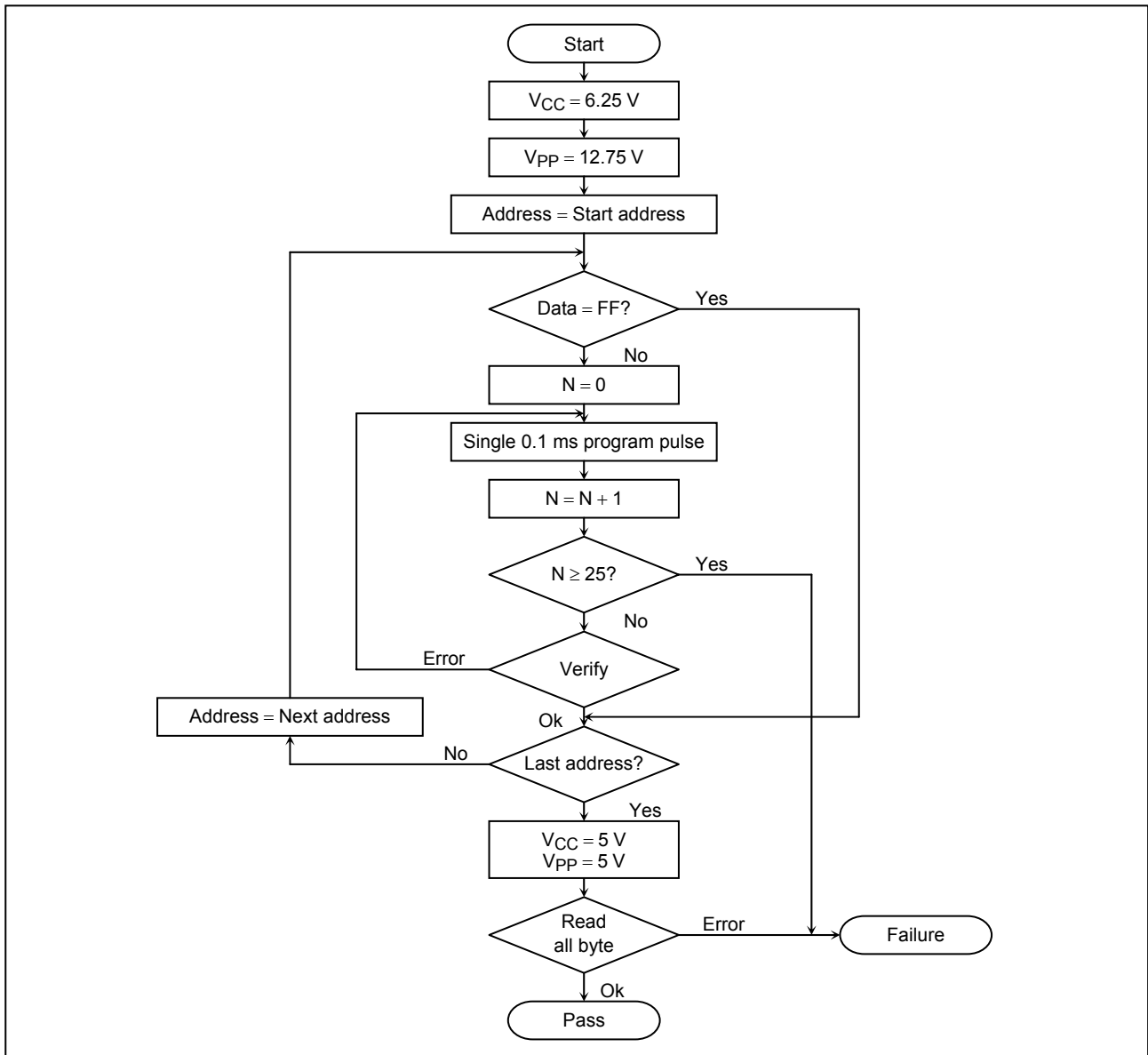

Figure 1.3.1 Flow Chart of High-speed Programming

1.4 Writing Method for General-purpose PROM Program

(1) Adapters

BM11174A: TMP88PS38N

BM11175A: TMP88PS38F

(2) PROM programmer specifying

i) PROM type is specified to TC571000D. (Note 1)

Writing voltage: 12.75 V (High-speed programming mode)

ii) Data transfer (copy) (Note 1)

In the TMP88PS38, EPROM is within the addresses 10000H to 1FEFFH (Program storage area) and 0A000H to 0FFFFH (OSD font area) and 1FF00H to 1FFFFH (Vector table storage area). Data is required to be transferred (Copied) to the addresses where it is possible to write. The program area in MCU mode and PROM mode is referred to "Program memory area" in Figure 1.1.

iii) Writing address is specified. (Note 1)

Start address: 0A000H

End address: 1FFFFH

(3) Writing

Writing/Verifying is required to be executed in accordance with PROM programmer operating procedure.

Note 1: The specifying method is referred to the PROM programmer description. Either write the data FFH to the unused area or set the PROM programmer to access only the program storage area.

Note 2: When MCU is set to an adapter or the adapter is set to PROM programmer, a position of pin 1 must be adjusted. If the setting is reversed, MCU, the adapter and PROM program is damaged.

Input/Output Circuit

(1) Control pins

The input/output circuitries of the TMP88PS38 control pins are shown below.

Control Pin	I/O	Input/Output Circuitry	Remarks
XIN XOUT	I/O		Resonator connection pins (High frequency) $R_f = 1.2\text{ M}\Omega$ (typ.) $R_O = 0.5\text{ k}\Omega$ (typ.)
$\overline{\text{RESET}}$	I/O		Sink open-drain output Hysteresis input Pull-up resistor $R_{IN} = 220\text{ k}\Omega$ (typ.) $R = 1\text{ k}\Omega$ (typ.)
$\overline{\text{STOP}} / \overline{\text{INT5}}$ (P20)	Input		Hysteresis input $R = 1\text{ k}\Omega$ (typ.)
TEST	Input		$R = 1\text{ k}\Omega$ (typ.)

(2) Input/output ports

Port	I/O	Input/Output Circuitry	Remarks
P20	I/O	<p>Initial "High-Z"</p>	<p>Sink open-drain output Hysteresis input</p> <p>R = 1 kΩ (typ.)</p>
P30 to P33, P50, P57, P70, P71	I/O	<p>Initial "High-Z"</p> <p>Disable</p>	<p>Tri-state I/O Hysteresis input</p> <p>R = 1 kΩ (typ.)</p>
P34, P35, P51, P52	I/O	<p>Open-drain output enable</p> <p>Initial "High-Z"</p> <p>Disable</p>	<p>Tri-state I/O or open-drain output programmable Hysteresis input</p> <p>R = 1 kΩ (typ.)</p>
P40 to P47	I/O	<p>Initial "High-Z"</p> <p>Disable</p>	<p>Tri-state I/O</p> <p>R = 1 kΩ (typ.)</p>
P53 to P56	I/O	<p>Initial "High-Z"</p> <p>Disable</p>	<p>Tri-state I/O Hysteresis input Key-on wakeup input ($V_{IL4} = 0.65 \times V_{DD}$)</p> <p>R = 1 kΩ (typ.) R_A = 5 kΩ (typ.) C_A = 22 pF (typ.)</p>

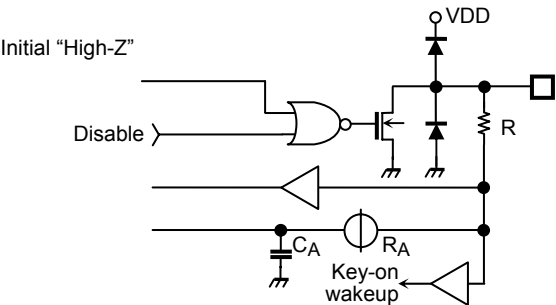
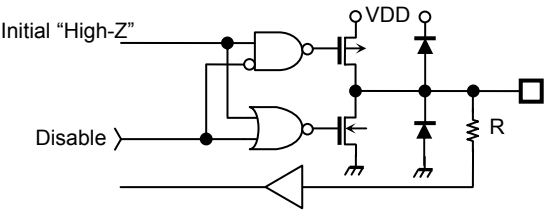
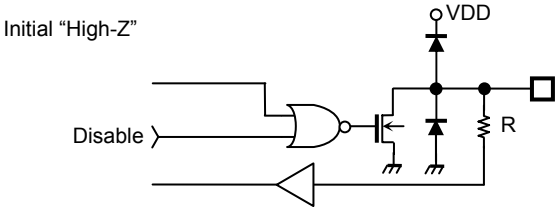
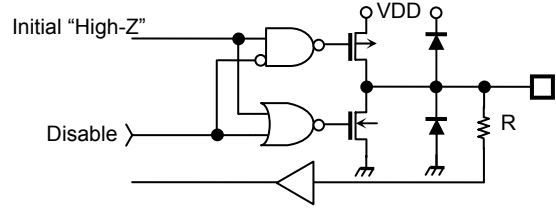
Port	I/O	Input/Output Circuitry	Remarks
P60, P61	I/O	 <p>Initial "High-Z"</p> <p>Disable</p> <p>VDD</p> <p>R</p> <p>CA</p> <p>RA</p> <p>Key-on wakeup</p>	<p>Sink open-drain output High current output $I_{OL} = 20 \text{ mA (typ.)}$</p> <p>$R = 1 \text{ k}\Omega \text{ (typ.)}$ $R_A = 5 \text{ k}\Omega \text{ (typ.)}$ $C_A = 22 \text{ pF (typ.)}$</p> <p>Key-on wakeup input ($V_{IL4} = 0.65 \times V_{DD}$)</p>
P62 (at CSOUT)	I/O	 <p>Initial "High-Z"</p> <p>Disable</p> <p>VDD</p> <p>R</p>	<p>Tri-state I/O High current output $I_{OL} = 20 \text{ mA (typ.)}$</p> <p>$R = 1 \text{ k}\Omega \text{ (typ.)}$</p>
P62, P63	I/O	 <p>Initial "High-Z"</p> <p>Disable</p> <p>VDD</p> <p>R</p>	<p>Sink open-drain output High current output $I_{OL} = 20 \text{ mA (typ.)}$</p> <p>$R = 1 \text{ k}\Omega \text{ (typ.)}$</p>
P64 to P67	I/O	 <p>Initial "High-Z"</p> <p>Disable</p> <p>VDD</p> <p>R</p>	<p>Tri-state I/O</p> <p>$R = 1 \text{ k}\Omega \text{ (typ.)}$</p>

Electrical Characteristics

Absolute Maximum Ratings

(V_{SS} = 0 V)

Parameter	Symbol	Pins	Ratings	Unit
Supply voltage	V _{DD}	–	–0.3 to 6.5	V
Programmable voltage	V _{PP}	TEST/V _{PP} Pin	–0.3 to 13.0	
Input voltage	V _{IN}	–	–0.3 to V _{DD} + 0.3	
Output voltage	V _{OUT1}	–	–0.3 to V _{DD} + 0.3	
Output current (Per 1 pin)	I _{OUT1}	Ports P2, P3, P4, P5, P64 to P67, P7	3.2	mA
	I _{OUT2}	Ports P60 to P63	30	
Output current (Total)	Σ I _{OUT1}	Ports P2, P3, P4, P5, P64 to P67, P7	120	
	Σ I _{OUT2}	Ports P60 to P63	120	
Power dissipation [T _{opr} = 70°C]	PD	–	600	mW
Soldering temperature (Time)	T _{sld}	–	260 (10 s)	°C
Storage temperature	T _{stg}	–	–55 to 125	
Operating temperature	T _{opr}	–	–30 to 70	

Note: The absolute maximum ratings are rated values which must not be exceeded during operation, even for an instant. Any one of the ratings must not be exceeded. If any absolute maximum rating is exceeded, a device may break down or its performance may be degraded, causing it to catch fire or explode resulting in injury to the user. Thus, when designing products which include this device, ensure that no absolute maximum rating value will ever be exceeded.

Recommended Operating Conditions

(V_{SS} = 0 V, T_{opr} = –30 to 70°C)

Parameter	Symbol	Pins	Conditions	Min	Max	Unit				
Supply voltage	V _{DD}	–	fc = 16 MHz NORMAL mode	4.5	5.5	V				
			fc = 16 MHz IDLE mode							
			– STOP mode							
Input high voltage	V _{IH1}	Except hysteresis input	V _{DD} = 4.5 to 5.5V	V _{DD} × 0.70	V _{DD}	V				
	V _{IH2}	Hysteresis input					V _{DD} × 0.75			
Input low voltage	V _{IL1}	Except hysteresis input	V _{DD} = 4.5 to 5.5V	0	V _{DD} × 0.30	V				
	V _{IL2}	Hysteresis input			V _{DD} × 0.25					
	V _{IL4}	Key-on wakeup input			V _{DD} × 0.65					
Clock frequency	fc	XIN, XOUT	V _{DD} = 4.5 to 5.5V	8.0	16.0	MHz				
				f _{OSC}	Internal clock		V _{DD} = 4.5 to 5.5V	fc = 8 MHz	8.0	12.0
								fc = 16 MHz	16.0	24.0

Note 1: The recommended operating conditions for a device are operating conditions under which it can be guaranteed that the device will operate as specified. If the device is used under operating conditions other than the recommended operating conditions (Supply voltage, operating temperature range, specified AC/DC values etc.), malfunction may occur. Thus, when designing products which include this device, ensure that the recommended operating conditions for the device are always adhered to.

Note 2: Clock frequency fc: Supply voltage range is specified in NORMAL mode and IDLE mode.

Note 3: Smaller value is alternatively specified as the maximum value.

DC Characteristics

(V_{SS} = 0 V, Topr = -30 to 70°C)

Parameter	Symbol	Pins	Conditions	Min	Typ.	Max	Unit
Hysteresis voltage	V _{HS}	Hysteresis inputs		-	0.9	-	V
Input current	I _{IN1}	TEST	V _{DD} = 5.5 V, V _{IN} = 5.5 V/0 V	-	-	±2	μA
	I _{IN2}	Open-drain ports	V _{DD} = 5.5 V, V _{IN} = 5.5 V/0 V	-	-	±2	
	I _{IN3}	Tri-state ports	V _{DD} = 5.5 V, V _{IN} = 5.5 V/0 V	-	-	±2	
	I _{IN4}	RESET, STOP	V _{DD} = 5.5 V, V _{IN} = 5.5 V/0 V	-	-	±2	
Input resistance	R _{IN2}	RESET	V _{DD} = 5.5 V, V _{IN} = 0 V	100	220	450	kΩ
Output leakage current	I _{LO1}	Sink open-drain ports	V _{DD} = 5.5 V, V _{OUT} = 5.5 V	-	-	2	μA
	I _{LO2}	Tri-state ports	V _{DD} = 5.5 V, V _{OUT} = 5.5 V/0 V	-	-	±2	
Output high voltage	V _{OH2}	Tri-state ports	V _{DD} = 4.5 V, I _{OH} = -0.7 mA	4.1	-	-	V
Output low voltage	V _{OL}	Except XOUT and ports P60 to P63	V _{DD} = 4.5 V, I _{OL} = 1.6 mA	-	-	0.4	
Output low current	I _{OL3}	Port P60 to P63	V _{DD} = 4.5 V, V _{OL} = 1.0 V	-	20	-	mA
Supply current in NORMAL mode	I _{DD}	-	V _{DD} = 5.5 V fc = 16 MHz V _{IN} = 5.3 V/0.2 V (Note 3)	-	25	30	
Supply current in IDLE mode				-	20	25	
Supply current in STOP mode				-	0.5	10	μA

Note 1: Typical values show those at Topr = 25°C, V_{DD} = 5 V.

Note 2: Input Current I_{IN3}: The current through resistor is not included.

Note 3: Supply Current I_{DD}: The current (Typ. 0.5 mA) through ladder resistors of ADC is included in NORMAL mode and IDLE mode.

AD Conversion Characteristics

(V_{SS} = 0 V, V_{DD} = 4.5 V to 5.5 V, Topr = -30 to 70°C)

Parameter	Symbol	Conditions	Min	Typ.	Max	Unit
Analog reference voltage	V _{AREF}	supplied from V _{DD} pin.	-	V _{DD}	-	V
	V _{ASS}	supplied from V _{SS} pin.	-	0	-	
Analog reference voltage range	ΔV _{AREF}	= V _{DD} - V _{SS}	-	V _{DD}	-	
Analog input voltage	V _{AIN}		V _{SS}	-	V _{DD}	LSB
Nonlinearity error		V _{DD} = 5.0 V	-	-	±1	
Zero point error			-	-	±2	
Full scale error			-	-	±2	
Total error			-	-	±3	

Note: The total error means all error except quanting error.

AC Characteristics

(V_{SS} = 0 V, V_{DD} = 4.5 V to 5.5 V, Topr = -30 to 70°C)

Parameter	Symbol	Conditions	Min	Typ.	Max	Unit
Machine cycle time	t _{cy}	in NORMAL mode	0.5	-	1.0	μs
		in IDLE mode				
High level clock pulse width	T _{WCH}	for external clock operation (XIN input), f _c = 16 MHz	31.25	-	-	ns
Low level clock pulse width	T _{WCL}					

Recommended oscillating conditions

(V_{SS} = 0 V, V_{DD} = 4.5 V to 5.5 V, Topr = -30 to 70°C)

Parameter	Oscillator	Oscillation Frequency	Recommended Oscillator	Recommended Constant	
				C ₁	C ₂
High-frequency oscillation	Ceramic resonator	8 MHz	Murata CSA 8.00MTZ	30 pF	30 pF
		16 MHz	Murata CSA 16.00MXZ040	5 pF	5 pF

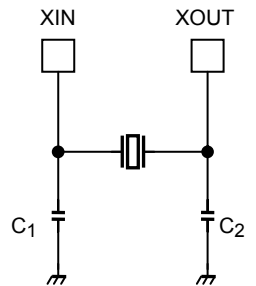

High-frequency oscillation

Note 1: To keep reliable operation, shield the device electrically with the metal plate on its package mold surface against the high electric field, for example, by CRT (Cathode ray tube).

Note 2: The product numbers and specifications of the resonators by Murata Manufacturing Co., Ltd. are subject to change. For up-to-date information, please refer to the following URL;

<http://www.murata.co.jp/search/index.html>

DC/AC Characteristics (PROM mode)

(V_{SS} = 0 V)

(1) Read operation (V_{DD} = 5.0 ± 0.25 V, T_{opr} = 25 ± 5°C)

Parameter	Symbol	Conditions	Min	Typ.	Max	Unit
Input high voltage (A0 to A16, \overline{CE} , \overline{OE} , \overline{PGM})	V _{IH4}		V _{DD} × 0.7	–	V _{DD}	V
Input low voltage (A0 to A16, \overline{CE} , \overline{OE} , \overline{PGM})	V _{IL4}		0	–	0.8	
Program power supply voltage	V _{PP}		4.75	5.0	5.25	
Address access time	t _{ACC}		–	1.5tcyc + 300	–	ns

Note: tcyc = 400 ns at 10 MHz

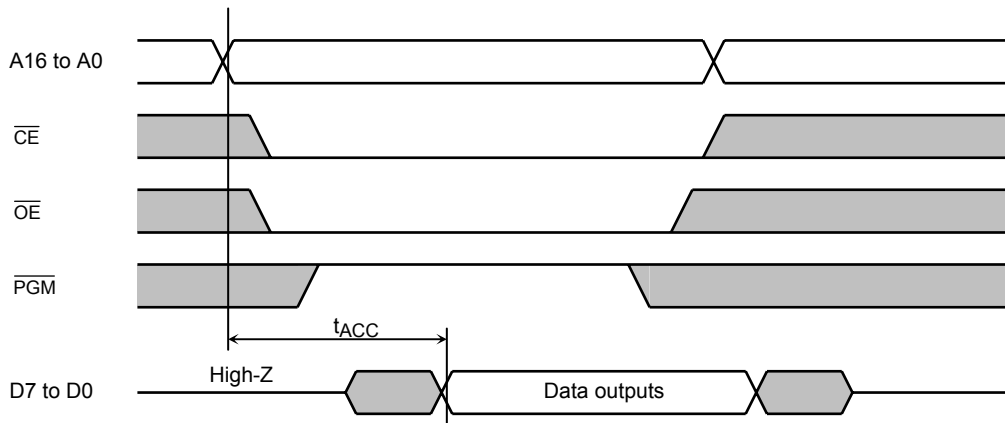

(2) High-speed programming operation (T_{opr} = 25 ± 5°C, V_{DD} = 6.25 ± 0.25 V)

Parameter	Symbol	Conditions	Min	Typ.	Max	Unit
Input high voltage (D0 to D7, A0 to A16, \overline{CE} , \overline{OE} , \overline{PGM})	V _{IH4}		V _{DD} × 0.7	–	V _{DD}	V
Input low voltage (D0 to D7, A0 to A16, \overline{CE} , \overline{OE} , \overline{PGM})	V _{IL4}		0	–	0.8	
Program power supply voltage	V _{PP}		12.5	12.75	13.0	
Initial program pulse width	t _{PW}	V _{DD} = 6.0 V	0.095	0.1	0.105	ms

High-speed Programming Timing

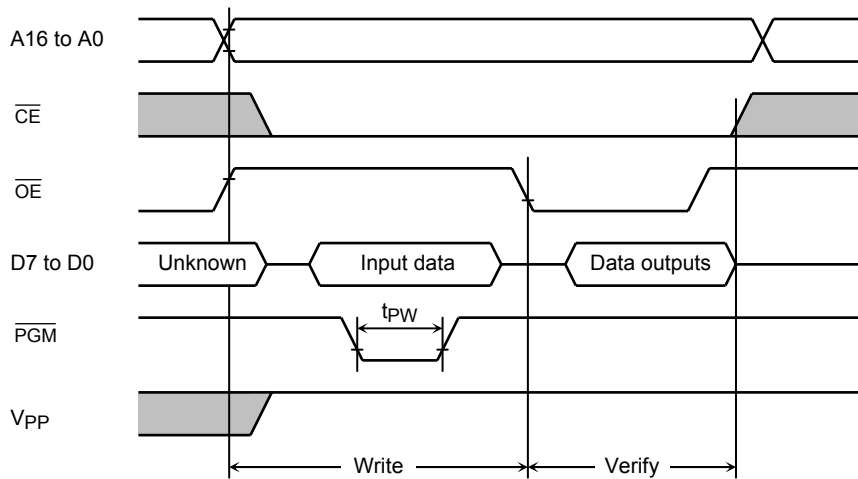

Note 1: When Vcc power supply is turned on or after, Vpp must be increased.

When Vcc power supply is turned off or before, Vpp must be increased.

Note 2: The device must not be set to the EPROM programmer or picked up from it under applying the program voltage ($12.75\text{ V} \pm 0.25\text{ V}$) to the Vpp pin as the device is damaged.

Note 3: Be sure to execute the recommended programming mode with the recommended programming adaptor. If a mode or an adaptor except the above, the misoperation sometimes occurs.

Package

P-SDIP42-600-1.78

Unit: mm

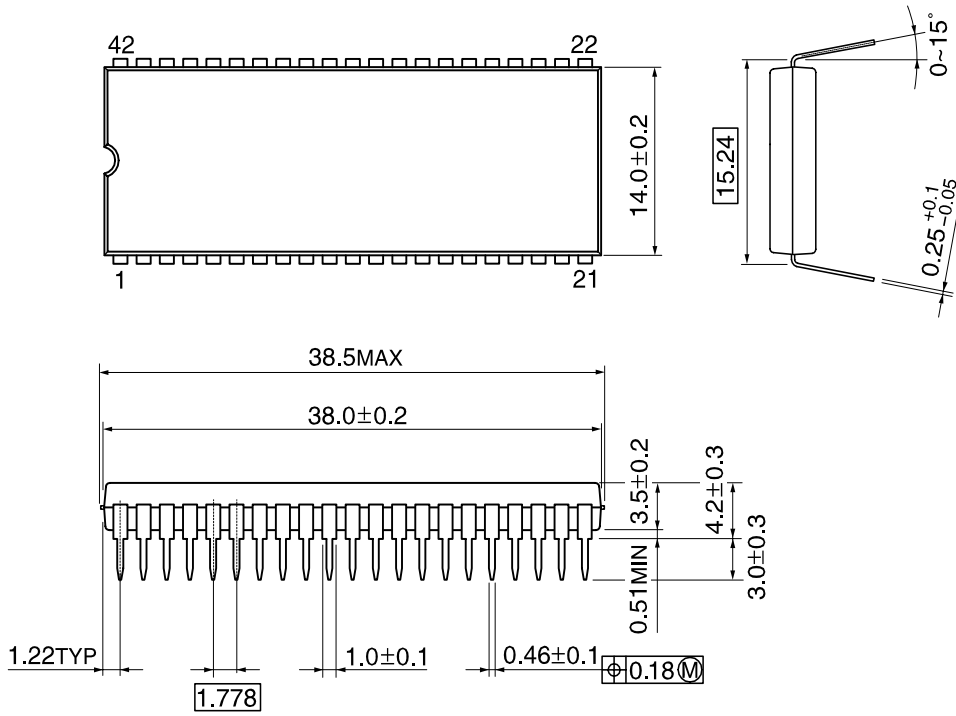

P-QFP44-1414-0.80K

Unit: mm

