



SEMITOR® 1

IGBT Module

SK25GB063

SK25GAL063

SK25GAR063

Preliminary Data

Features

- Compact design
- One screw mounting
- Heat transfer and isolation through direct copper bonding aluminium oxide ceramic (DBC)
- N-channel homogeneous silicon structure (NPT-Non punch-through IGBT)
- High short circuit capability
- Low tail current with low temperature dependence
- UL recognized, file no. E 63 532

Typical Applications

- Switching (not for linear use)
- Inverter
- Switched mode power supplies
- UPS

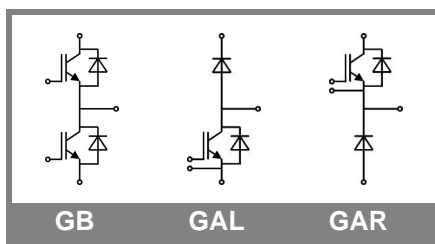

GB

GAL

GAR

Absolute Maximum Ratings		$T_s = 25\text{ °C}$, unless otherwise specified	
Symbol	Conditions	Values	Units
IGBT			
V_{CES}	$T_j = 25\text{ °C}$	600	V
I_C	$T_j = 125\text{ °C}$	$T_s = 25\text{ °C}$	30 A
		$T_s = 80\text{ °C}$	21 A
I_{CRM}	$I_{CRM} = 2 \times I_{Cnom}$, $t_p = 1\text{ ms}$	60	A
V_{GES}		± 20	V
t_{psc}	$V_{CC} = 300\text{ V}$; $V_{GE} \leq 20\text{ V}$; $T_j = 125\text{ °C}$ $V_{CES} < 600\text{ V}$	10	μs
Inverse Diode			
I_F	$T_j = 150\text{ °C}$	$T_s = 25\text{ °C}$	36 A
		$T_s = 80\text{ °C}$	24 A
I_{FRM}	$I_{FRM} = 2 \times I_{Fnom}$, $t_p = 1\text{ ms}$	50	A
Freewheeling Diode			
I_F	$T_j = 150\text{ °C}$	$T_s = 25\text{ °C}$	36 A
		$T_s = 80\text{ °C}$	24 A
I_{FRM}		50	A
Module			
$I_{t(RMS)}$			A
T_{vj}		-40 ... +150	$^{\circ}\text{C}$
T_{stg}		-40 ... +125	$^{\circ}\text{C}$
V_{isol}	AC, 1 min.	2500	V

Characteristics		$T_s = 25\text{ °C}$, unless otherwise specified			
Symbol	Conditions	min.	typ.	max.	Units
IGBT					
$V_{GE(th)}$	$V_{GE} = V_{CE}$, $I_C = 0,7\text{ mA}$	4,5	5,5	6,5	V
I_{CES}	$V_{GE} = 0\text{ V}$, $V_{CE} = V_{CES}$	$T_j = 25\text{ °C}$		0,1	mA
		$T_j = 125\text{ °C}$			mA
I_{GES}	$V_{CE} = 0\text{ V}$, $V_{GE} = 30\text{ V}$	$T_j = 25\text{ °C}$		120	nA
		$T_j = 125\text{ °C}$			nA
V_{CE0}		$T_j = 25\text{ °C}$	1		V
		$T_j = 125\text{ °C}$	0,8		V
r_{CE}	$V_{GE} = 15\text{ V}$	$T_j = 25\text{ °C}$	40		m Ω
		$T_j = 125\text{ °C}$	55		m Ω
$V_{CE(sat)}$	$I_{Cnom} = 30\text{ A}$, $V_{GE} = 15\text{ V}$	$T_j = 25\text{ °C}_{chiplev.}$	2	2,5	V
		$T_j = 125\text{ °C}_{chiplev.}$	1,9	2,4	V
C_{ies}	$V_{CE} = 25$, $V_{GE} = 0\text{ V}$	$f = 1\text{ MHz}$	1,3		nF
C_{oes}					nF
C_{res}			0,1		nF
Q_G	$V_{GE} = 0 \dots 20\text{ V}$		125		nC
$t_{d(on)}$	$R_{Gon} = 33\ \Omega$	$V_{CC} = 300\text{ V}$ $I_{Cnom} = 25\text{ A}$	30		ns
t_r			35		ns
E_{on}			1,25		mJ
$t_{d(off)}$	$R_{Goff} = 33\ \Omega$	$T_j = 125\text{ °C}$ $V_{GE} = \pm 15\text{ V}$	200		ns
t_f			25		ns
E_{off}			0,9		mJ
$R_{th(j-s)}$	per IGBT			1,4	K/W



SEMITOP® 1

IGBT Module

SK25GB063

SK25GAL063

SK25GAR063

Preliminary Data

Features

- Compact design
- One screw mounting
- Heat transfer and isolation through direct copper bonding aluminium oxide ceramic (DBC)
- N-channel homogeneous silicon structure (NPT-Non punch-through IGBT)
- High short circuit capability
- Low tail current with low temperature dependence
- UL recognized, file no. E 63 532

Typical Applications

- Switching (not for linear use)
- Inverter
- Switched mode power supplies
- UPS

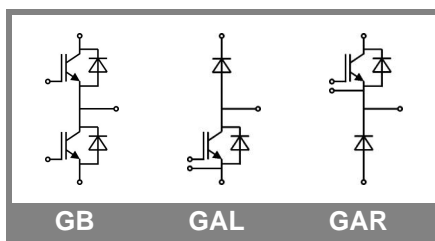

GB

GAL

GAR

Characteristics

Symbol	Conditions	min.	typ.	max.	Units
Inverse Diode					
$V_F = V_{EC}$	$I_{Fnom} = 25 \text{ A}; V_{GE} = 0 \text{ V}$	$T_j = 25 \text{ }^\circ\text{C}_{\text{chiplev.}}$	1,45	1,7	V
		$T_j = 125 \text{ }^\circ\text{C}_{\text{chiplev.}}$	1,4	1,75	V
V_{F0}		$T_j = 125 \text{ }^\circ\text{C}$	0,85	0,9	V
r_F		$T_j = 125 \text{ }^\circ\text{C}$	22	32	mΩ
I_{RRM}	$I_{Fnom} = 25 \text{ A}$	$T_j = 125 \text{ }^\circ\text{C}$	16		A
Q_{rr}	$di/dt = -500 \text{ A}/\mu\text{s}$		2		μC
E_{rr}	$V_{CC} = 300 \text{ V}$		0,25		mJ
$R_{th(j-s)D}$	per diode			1,7	K/W
Freewheeling Diode					
$V_F = V_{EC}$	$I_{Fnom} = 25 \text{ A}; V_{GE} = 0 \text{ V}$	$T_j = 25 \text{ }^\circ\text{C}_{\text{chiplev.}}$	1,45	1,7	V
		$T_j = 125 \text{ }^\circ\text{C}_{\text{chiplev.}}$	1,4	1,75	V
V_{F0}		$T_j = 125 \text{ }^\circ\text{C}$	0,85	0,9	V
r_F		$T_j = 125 \text{ }^\circ\text{C}$	22	32	V
I_{RRM}	$I_{Fnom} = 25 \text{ A}$	$T_j = 125 \text{ }^\circ\text{C}$	16		A
Q_{rr}	$di/dt = -500 \text{ A}/\mu\text{s}$		2		μC
E_{rr}	$V_R = 300 \text{ V}$		0,25		mJ
$R_{th(j-s)FD}$	per diode			1,7	K/W
M_s	to heat sink M1			1,5	Nm
w			13		g

This is an electrostatic discharge sensitive device (ESDS), international standard IEC 60747-1, Chapter IX.

This technical information specifies semiconductor devices but promises no characteristics. No warranty or guarantee expressed or implied is made regarding delivery, performance or suitability.

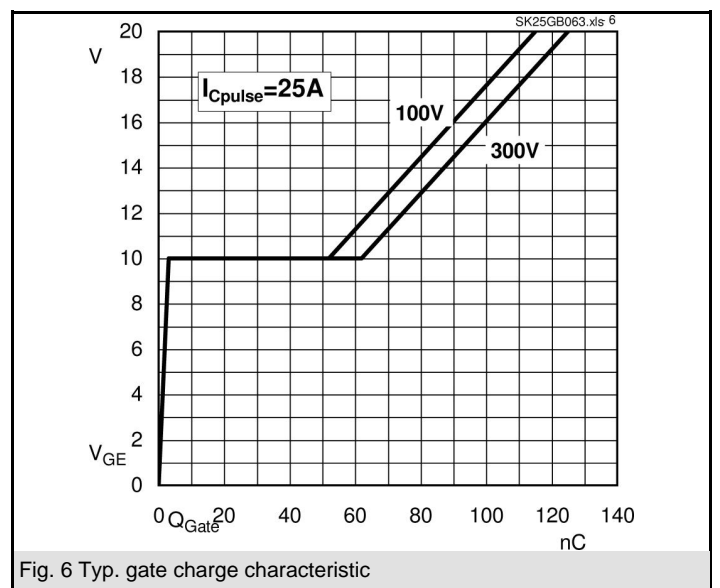
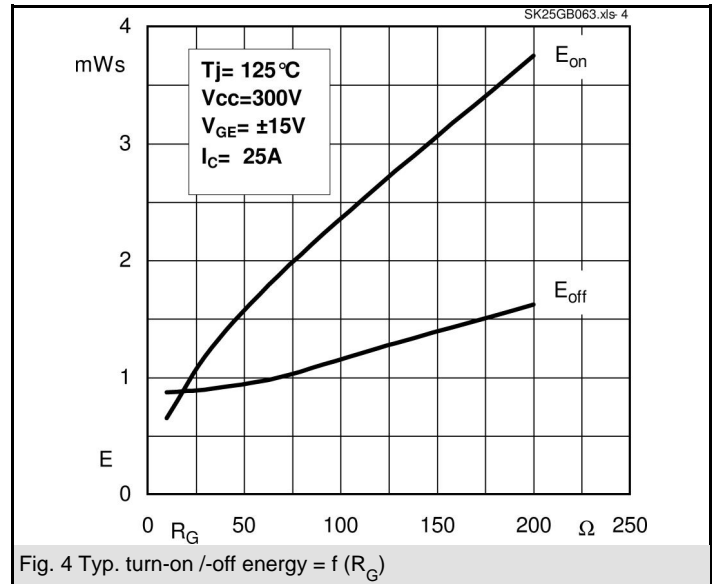
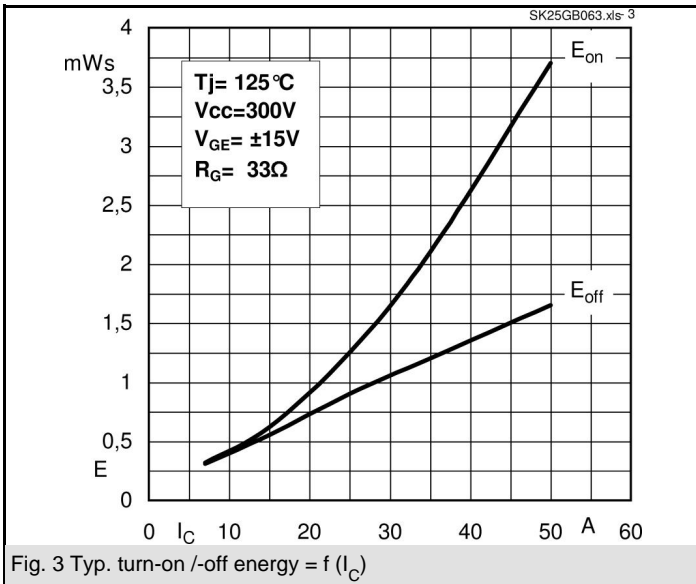
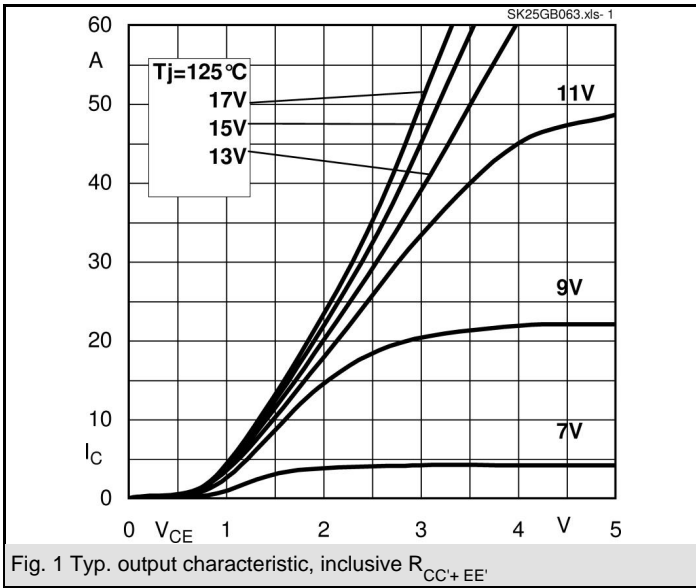

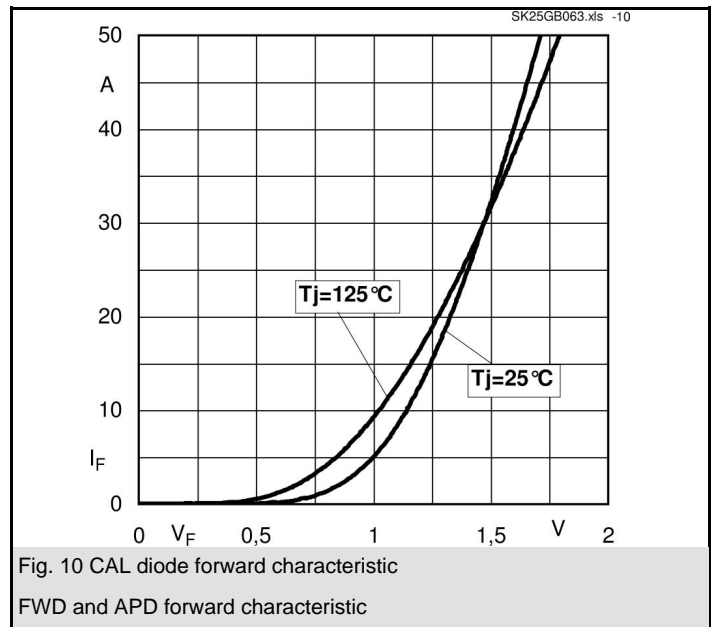
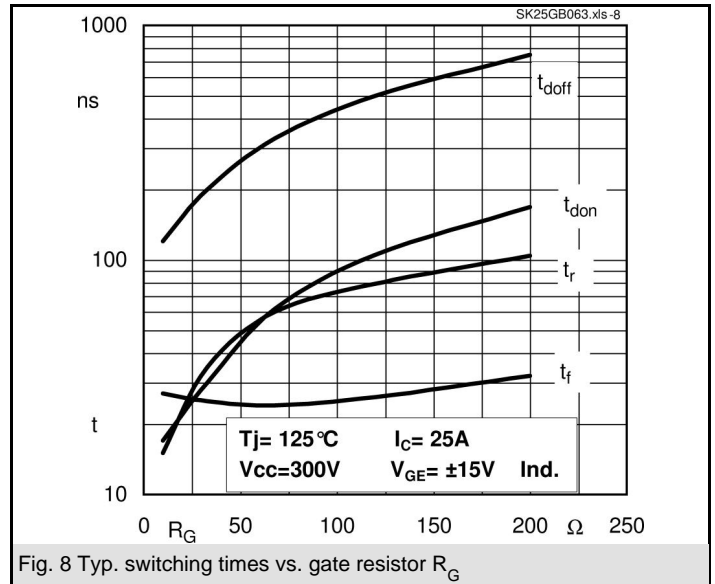
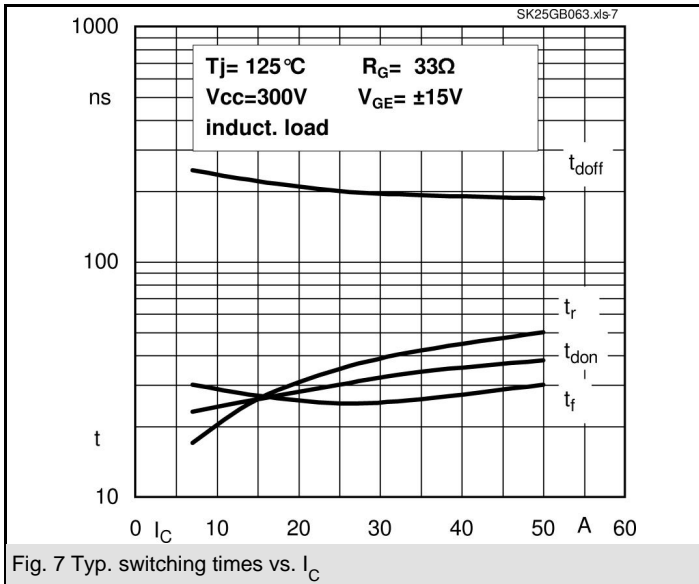

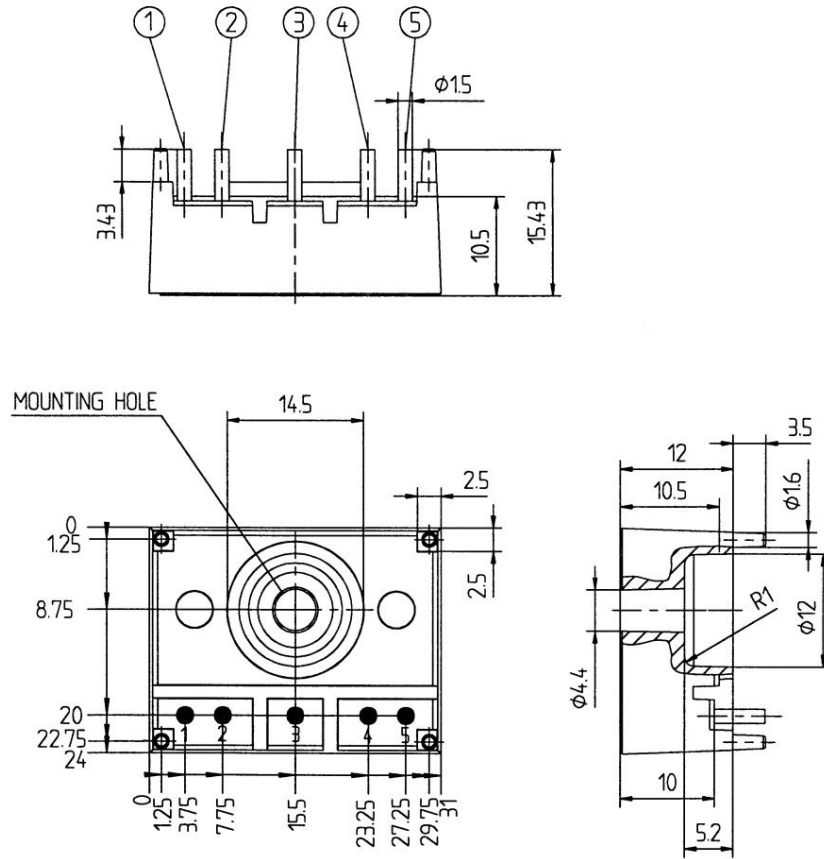

Case T3 (Suggested hole diameter, in the PCB, for solder pins and plastic mounting pins: 2mm)

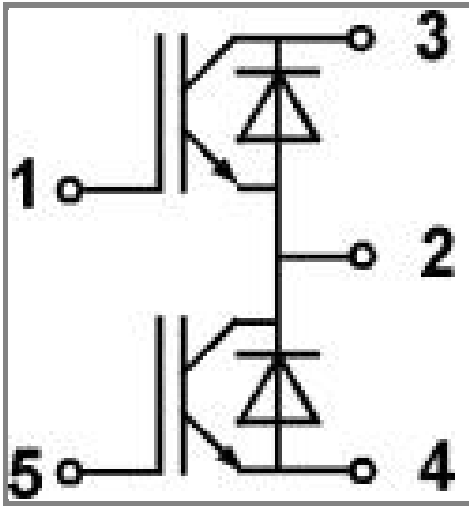

Case T3

GB

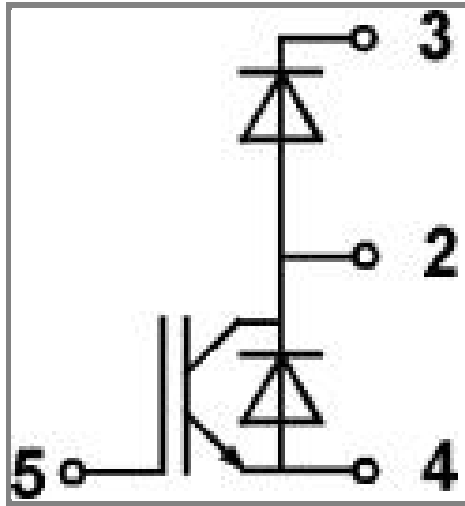

Case T3

GAL

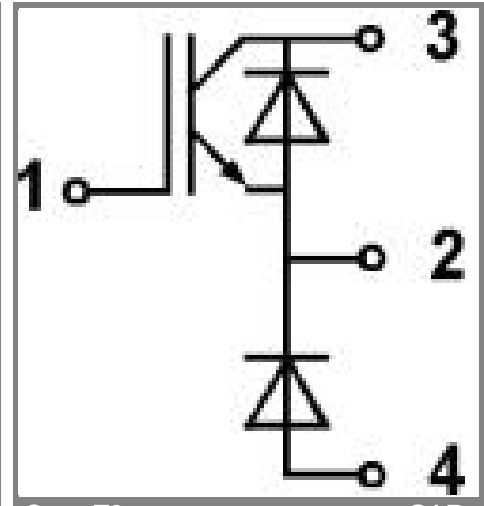

Case T3

GAR