

TOSHIBA Bipolar Linear Integrated Circuit Silicon Monolithic

TA8256BH

Audio Power Amplifier 6 W × 3 Ch

TA8256BH is 3 channel audio power amplifier for Consumer applications.

This IC provides an output power of 6 watts per channel (at $V_{CC} = 20\text{ V}$, $f = 1\text{ kHz}$, $\text{THD} = 10\%$, $R_L = 8\ \Omega$).

It is suitable for power amplifier of TV and home Stereo.

Features

- High output power: $P_{out} = 6\text{ W}$ (Typ.)
($V_{CC} = 20\text{ V}$, $R_L = 8\ \Omega$, $f = 1\text{ kHz}$, $\text{THD} = 10\%$)
- Built-in audio muting circuit.
- NF terminal capacitor less
: Fixed gain ($G_V = 34\text{dB}$), needless external capacitor.
- Protectors
: Thermal shut down protection circuit, over voltage protection circuit
- Low popping noise
- High THD ratio
- High input dynamic range
- Available for using same PCB layout with 2 channel IC: TA8246AH
- Operating supply voltage range
: $V_{CC}(\text{opr}) = 10\sim 30\text{ V}$ ($T_a = 25^\circ\text{C}$)

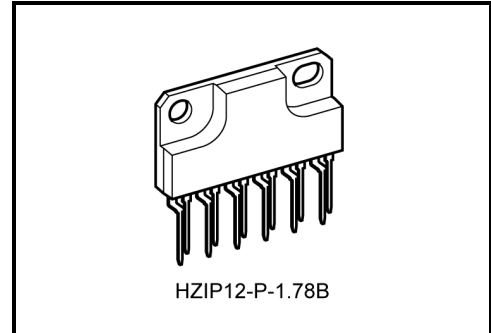

Weight: 4.04 g (typ.)

Block Diagram

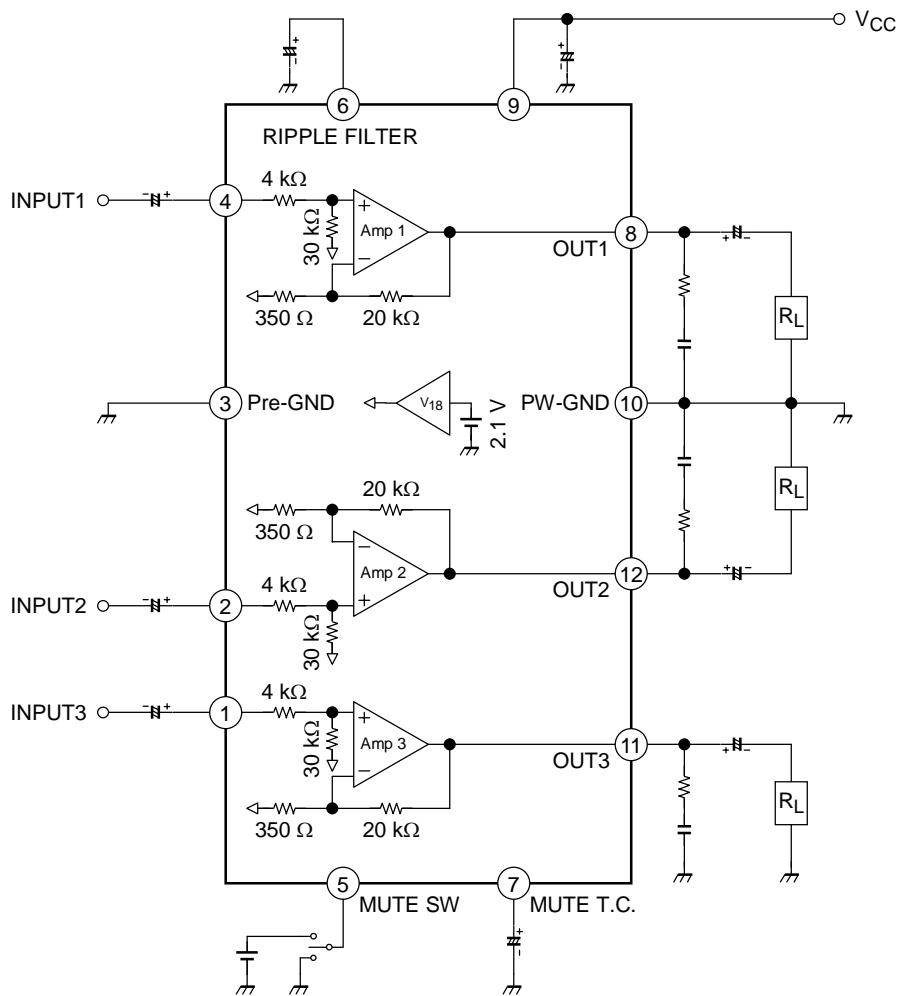

Terminal Explanation

Terminal No.	Symbol	Function	Equivalent Circuit
1	IN3	Input	
2	IN2		
4	IN1		
3	Pre-GND	GND terminal	—
5	MUTE SW	MUTE control terminal	
7	MUTE T.C.		
6	R/F	Ripple filter	
8	OUT1	Output	
11	OUT3		
12	OUT2		
9	V _{CC}	Supply voltage terminal	—
10	PW-GND	GND terminal	—

Cautions

This IC is not proof enough against a strong E-M field by CRT which may cause malfunction such as leak. Please set the IC keeping the distance from CRT.

Maximum Ratings (Ta = 25°C)

Characteristic	Symbol	Rating	Unit
Supply voltage	V _{CC}	30	V
Output current (peak/ch)	I _O (peak)	2	A
Power dissipation	P _D (Note)	25	W
Operating temperature	T _{opr}	-20~75	°C
Storage temperature	T _{stg}	-55~150	°C

Note: Derated above Ta = 25°C in the proportion of 200 mW/°C.

Electrical Characteristics

(Unless otherwise specified, V_{CC} = 20 V, R_L = 8 Ω, R_g = 620 Ω, f = 1 kHz, Ta = 25°C)

Characteristic	Symbol	Test Circuit	Test Condition	Min.	Typ.	Max	Unit
Quiescent current	I _{CCQ}	—	V _{in} = 0	65	100	180	mA
Output power	P _{out} (1)	—	THD = 10%	5	6	—	W
	P _{out} (2)	—	THD = 1%	—	4.5	—	
Total harmonic distortion	THD (1)	—	P _{out} = 2 W	—	0.04	0.2	%
	THD (2)	—	P _{out} = 2 W, f = 10 kHz,	—	0.1	0.6	
Voltage gain	G _v	—	V _{out} = 0.775 V _{rms}	32.5	34	35.5	dB
Input resistance	R _{IN}	—	—	—	34	—	kΩ
Ripple rejection ratio	R.R.	—	f = 100 Hz, V _{ripple} = 0.775 V _{rms}	-40	-47	—	dB
Output noise voltage	V _{no}	—	R _g = 10 kΩ, BW = 20 Hz~20 kHz	—	0.14	0.3	mV _{rms}
Cross talk	C.T.	—	V _{out} = 0.775 V _{rms}	—	-60	—	dB
Mute control voltage	V _{th} (ON)	—	MUTE ON	3.1	—	V _{CC}	V
	V _{th} (OFF)	—	MUTE OFF	0	—	2.5	
Mute attenuation level	ATT	—	V _{out} = 0.775 V _{rms} → Mute	-52	-60	—	dB

Test Circuit

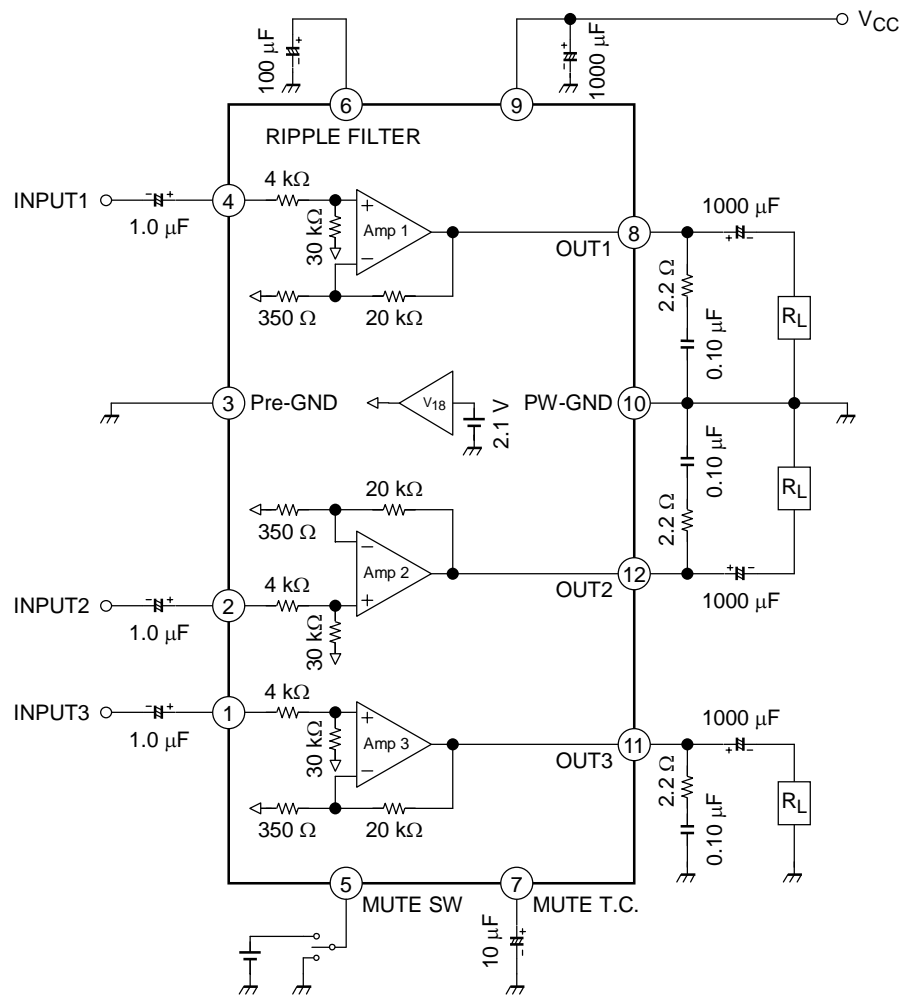

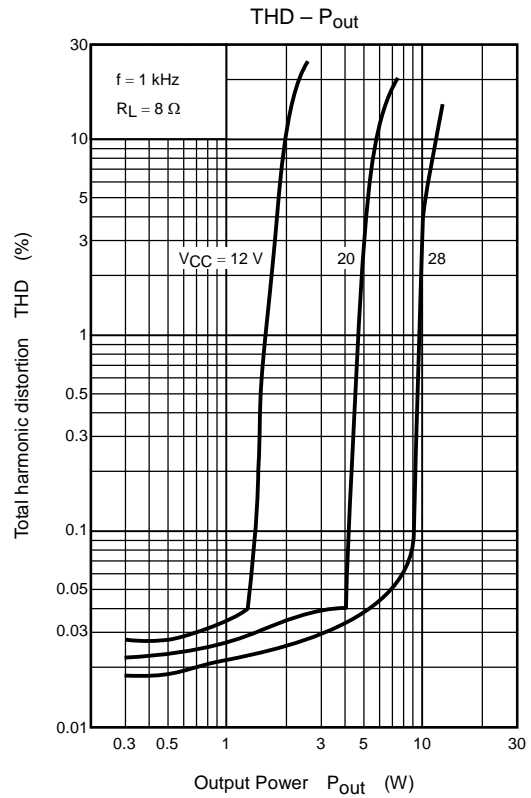
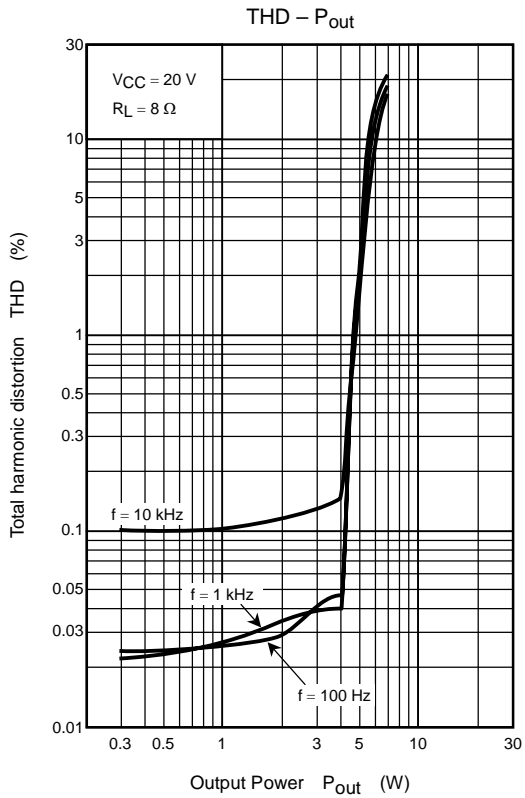
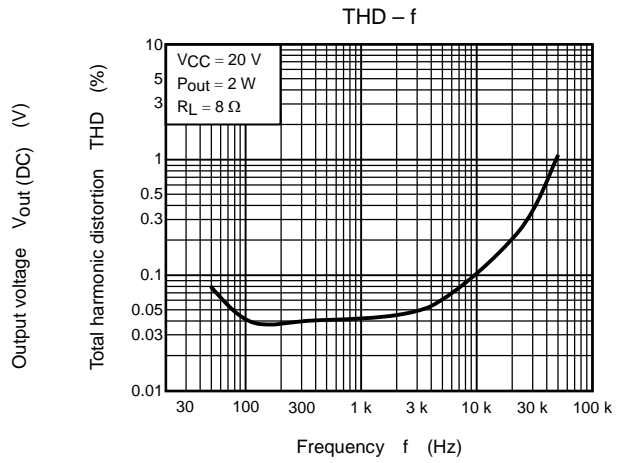
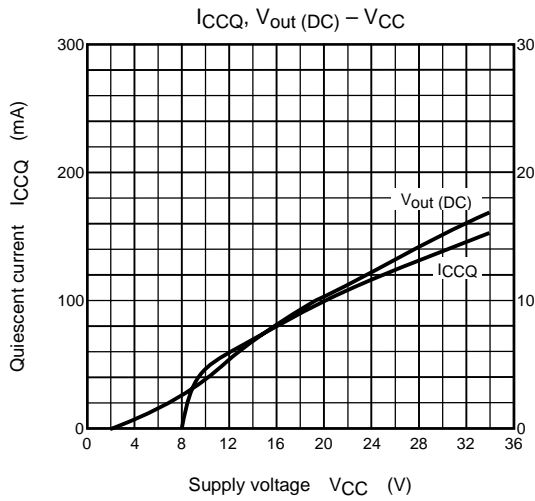

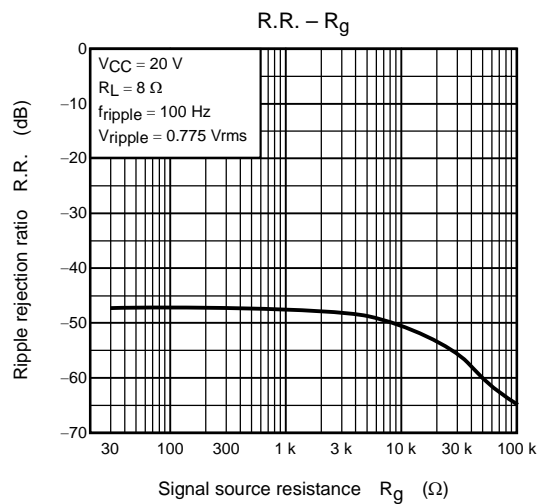
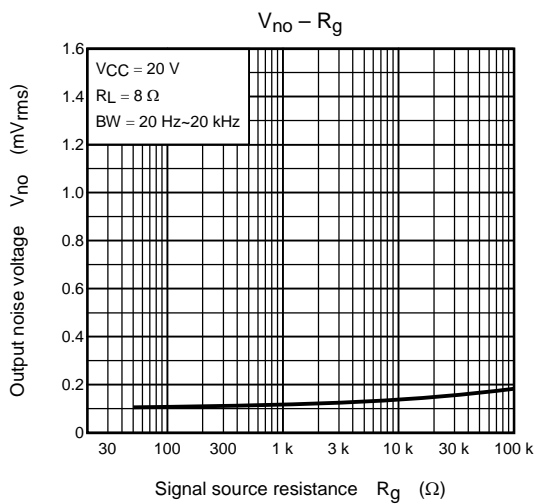
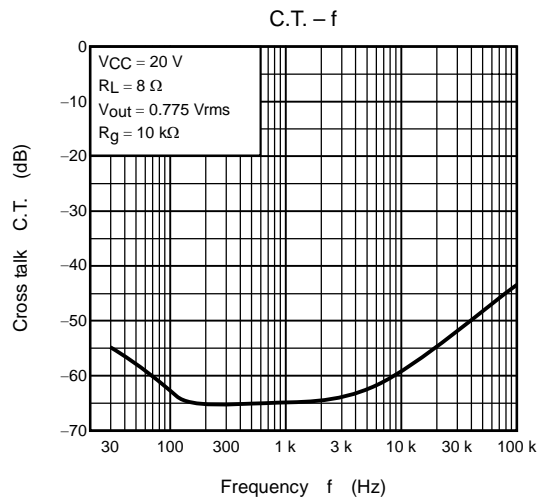
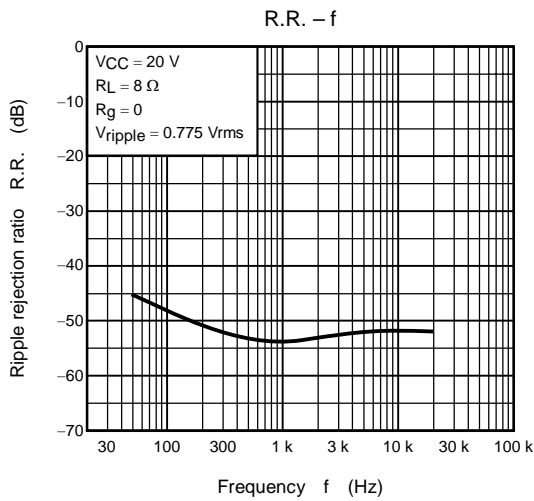
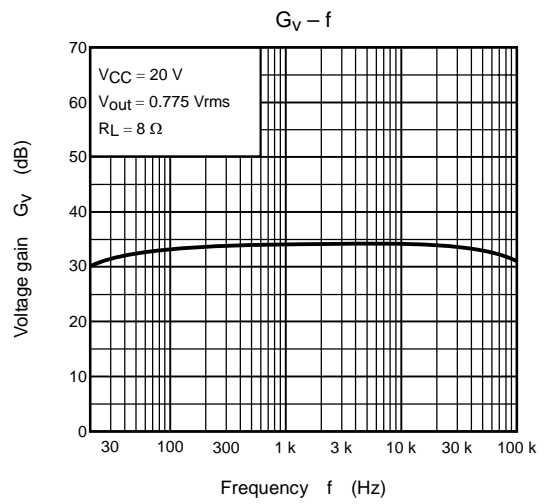
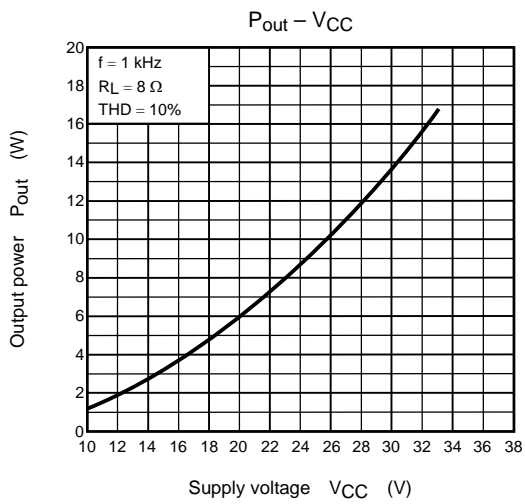

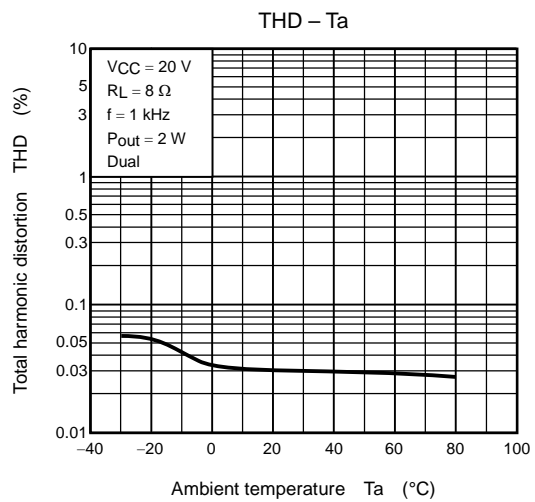
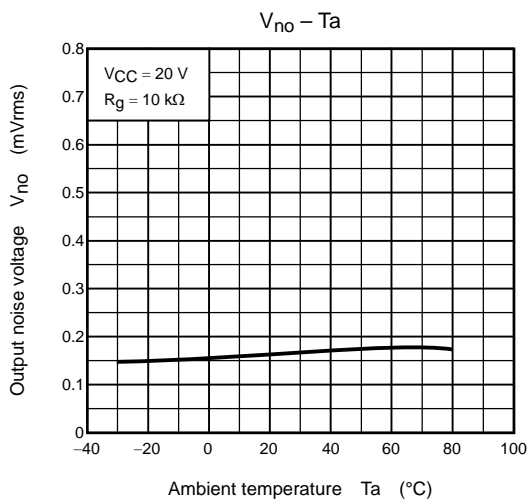
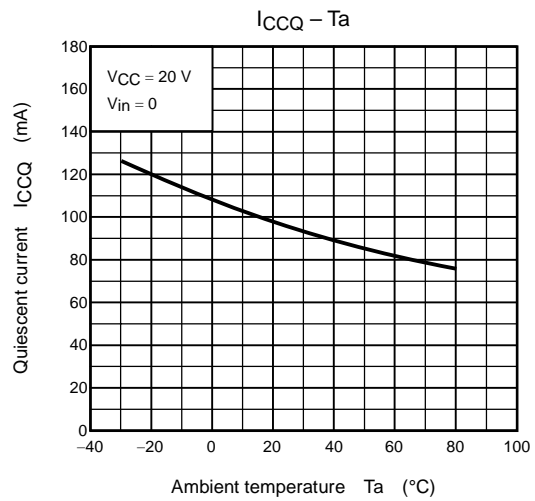
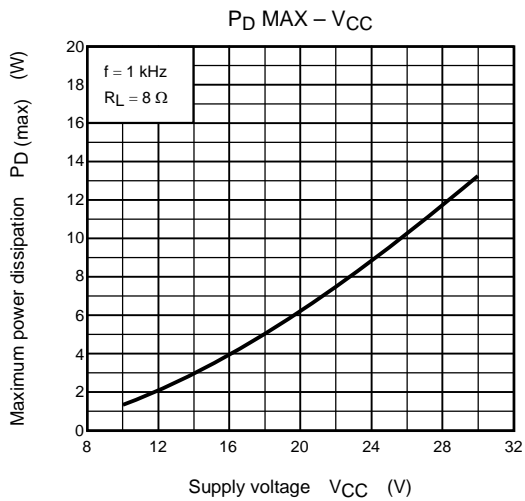
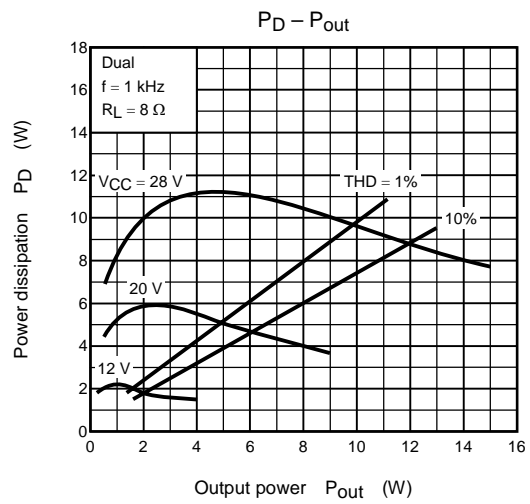
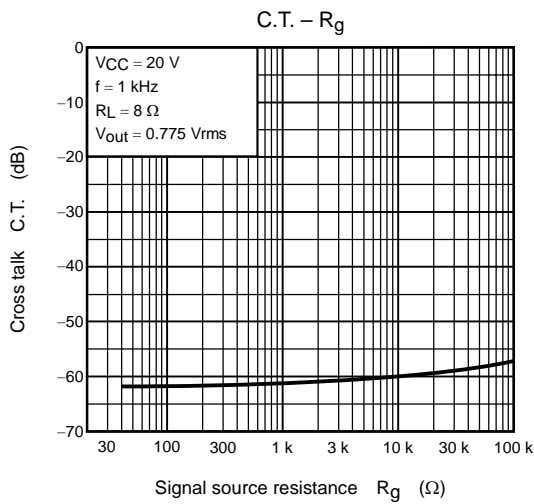

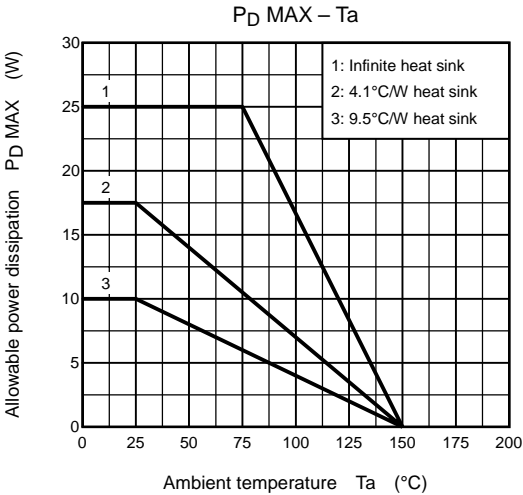

Package Dimensions

HZIP12-P-1.78B

Unit: mm

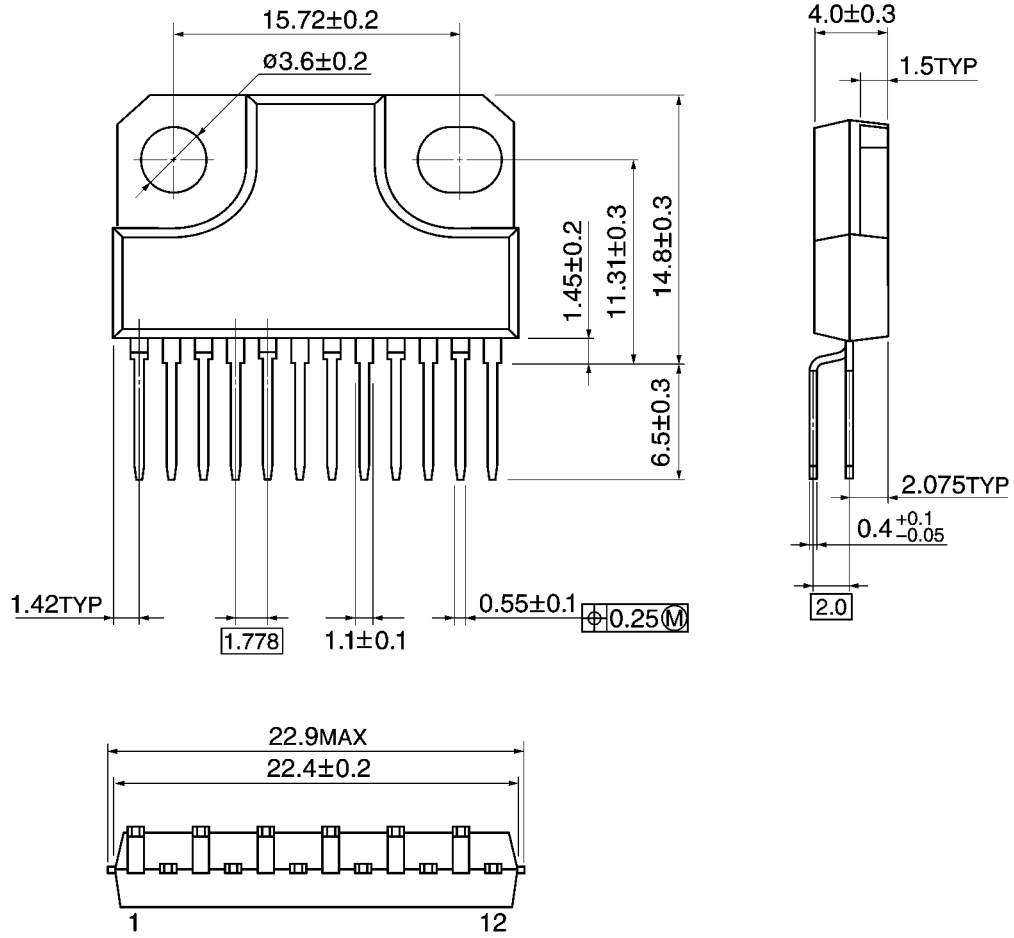

Weight: 4.04 g (typ.)

RESTRICTIONS ON PRODUCT USE

000707EBF

- TOSHIBA is continually working to improve the quality and reliability of its products. Nevertheless, semiconductor devices in general can malfunction or fail due to their inherent electrical sensitivity and vulnerability to physical stress. It is the responsibility of the buyer, when utilizing TOSHIBA products, to comply with the standards of safety in making a safe design for the entire system, and to avoid situations in which a malfunction or failure of such TOSHIBA products could cause loss of human life, bodily injury or damage to property.
In developing your designs, please ensure that TOSHIBA products are used within specified operating ranges as set forth in the most recent TOSHIBA products specifications. Also, please keep in mind the precautions and conditions set forth in the "Handling Guide for Semiconductor Devices," or "TOSHIBA Semiconductor Reliability Handbook" etc..
- The TOSHIBA products listed in this document are intended for usage in general electronics applications (computer, personal equipment, office equipment, measuring equipment, industrial robotics, domestic appliances, etc.). These TOSHIBA products are neither intended nor warranted for usage in equipment that requires extraordinarily high quality and/or reliability or a malfunction or failure of which may cause loss of human life or bodily injury ("Unintended Usage"). Unintended Usage include atomic energy control instruments, airplane or spaceship instruments, transportation instruments, traffic signal instruments, combustion control instruments, medical instruments, all types of safety devices, etc.. Unintended Usage of TOSHIBA products listed in this document shall be made at the customer's own risk.
- This product generates heat during normal operation. However, substandard performance or malfunction may cause the product and its peripherals to reach abnormally high temperatures.
The product is often the final stage (the external output stage) of a circuit. Substandard performance or malfunction of the destination device to which the circuit supplies output may cause damage to the circuit or to the product.
- The products described in this document are subject to the foreign exchange and foreign trade laws.
- The information contained herein is presented only as a guide for the applications of our products. No responsibility is assumed by TOSHIBA CORPORATION for any infringements of intellectual property or other rights of the third parties which may result from its use. No license is granted by implication or otherwise under any intellectual property or other rights of TOSHIBA CORPORATION or others.
- The information contained herein is subject to change without notice.