

TC75S56F, TC75S56FU, TC75S56FE

Single Comparator

The TC75S56F/TC75S56FU/TC75S56FE is a CMOS general-purpose single comparator. The device can operate off a single power supply and draws a lower supply current than a conventional bipolar general-purpose comparator. This device's push-pull output stage can be directly connected to TTL or CMOS logic ICs, among others.

Features

- Low-current power supply : $I_{DD} = 10 \mu A$ (typ.)
- Single power supply operation
- Wide common mode input voltage range: $V_{SS} \sim V_{DD} - 0.9 V$
- Push-pull output circuit
- Low input bias current
- Small package

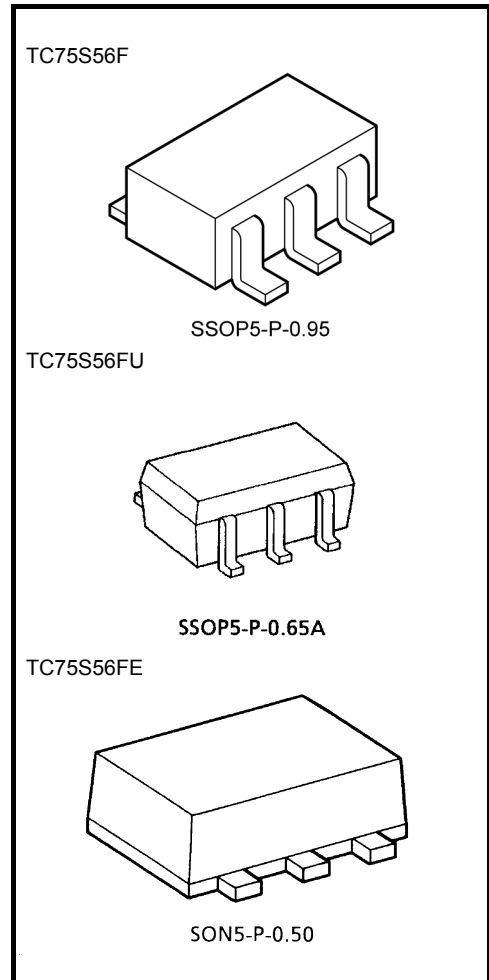

Weight
 SSOP5-P-0.95 : 0.014 g (typ.)
 SSOP5-P-0.65A : 0.006 g (typ.)
 SON5-P-0.50 : 0.003 g (typ.)

Marking (top view)

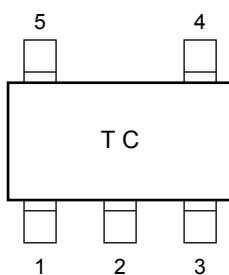

Pin Connection (top view)

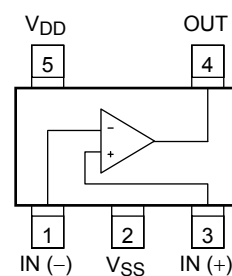

Absolute Maximum Ratings (Ta = 25°C)

Characteristics		Symbol	Rating	Unit
Supply voltage		V_{DD}, V_{SS}	± 3.5 or 7	V
Differential input voltage		DV_{IN}	± 7	V
Input voltage		V_{IN}	$V_{SS} \sim V_{DD}$	V
Output Current		I_{OUT}	± 35	mA
Power dissipation	TC75S56F/FU	P_D	200	mW
	TC75S56FE		100	
Operating temperature		T_{opr}	-40~85	°C
Storage temperature		T_{stg}	-55~125	°C

Note: Using continuously under heavy loads (e.g. the application of high temperature/current/voltage and the significant change in temperature, etc.) may cause this product to decrease in the reliability significantly even if the operating conditions (i.e. operating temperature/current/voltage, etc.) are within the absolute maximum ratings and the operating ranges.

Please design the appropriate reliability upon reviewing the Toshiba Semiconductor Reliability Handbook ("Handling Precautions"/"Derating Concept and Methods") and individual reliability data (i.e. reliability test report and estimated failure rate, etc).

Note: This device's CMOS structure makes it prone to latch-up. To prevent latch-up, please take the following precautions:

- Ensure that no I/O pin's voltage level ever exceeds V_{DD} or drops below V_{SS} . In addition, check the power-on timing.
- Do not subject the device to excessive noise.

Electrical Characteristics (unless otherwise specified, $V_{DD} = 5\text{ V}$, $V_{SS} = \text{GND}$, $T_a = 25^\circ\text{C}$)

Characteristics	Symbol	Test Circuit	Test Condition	Min	Typ.	Max	Unit
Input offset voltage	V_{IO}	—	—	—	± 1	± 7	mV
Input offset current	I_{IO}	—	—	—	1	—	pA
Input bias current	I_I	—	—	—	1	—	pA
Common mode input voltage	CMV_{IN}	—	—	0	—	4.1	V
Supply current	I_{DD} (Note)	—	—	—	11	22	μA
Voltage gain	G_V	—	—	—	94	—	dB
Sink current	I_{sink}	—	$V_{OL} = 0.5\text{ V}$	13	25	—	mA
Source current	I_{source}	—	$V_{OH} = 4.5\text{ V}$	9	21	—	mA
Output voltage	V_{OL}	—	$I_{sink} = 5.0\text{ mA}$	—	0.1	0.3	V
	V_{OH}	—	$I_{source} = 5.0\text{ mA}$	4.7	4.9	—	
Operating supply voltage	V_{DD}	—	—	1.8	—	7.0	V
Propagation delay time (turn on)	t_{PLH} (1)	—	Over drive = 100 mV	—	680	—	ns
	t_{PLH} (2)	—	TTL step input	—	500	—	
Propagation delay time (turn off)	t_{PHL} (1)	—	Over drive = 100 mV	—	250	—	ns
	t_{PHL} (2)	—	TTL step input	—	380	—	
Response time	t_{TLH}	—	Over drive = 100 mV	—	60	—	ns
	t_{THL}	—	Over drive = 100 mV	—	8	—	

Electrical Characteristics (unless otherwise specified, $V_{DD} = 3\text{ V}$, $V_{SS} = \text{GND}$, $T_a = 25^\circ\text{C}$)

Characteristics	Symbol	Test Circuit	Test Condition	Min	Typ.	Max	Unit
Input offset voltage	V_{IO}	—	—	—	± 1	± 7	mV
Input offset current	I_{IO}	—	—	—	1	—	pA
Input bias current	I_I	—	—	—	1	—	pA
Common mode input voltage	CMV_{IN}	—	—	0	—	2.1	V
Supply current	I_{DD} (Note)	—	—	—	10	20	μA
Sink current	I_{sink}	—	$V_{OL} = 0.5\text{ V}$	6	18	—	mA
Source current	I_{source}	—	$V_{OH} = 2.5\text{ V}$	3	15	—	mA
Output voltage	V_{OL}	—	$I_{sink} = 5.0\text{ mA}$	—	0.15	0.35	V
	V_{OH}	—	$I_{source} = 5.0\text{ mA}$	2.65	2.85	—	
Propagation delay time (turn on)	t_{PLH}	—	Over drive = 100 mV	—	550	—	ns
Propagation delay time (turn off)	t_{PHL}	—	Over drive = 100 mV	—	250	—	ns
Response time	t_{TLH}	—	Over drive = 100 mV	—	30	—	ns
	t_{THL}	—	Over drive = 100 mV	—	8	—	

Note: This device's current consumption increases as its operating frequency increases. Note that the power dissipation should not exceed the allowable power dissipation.

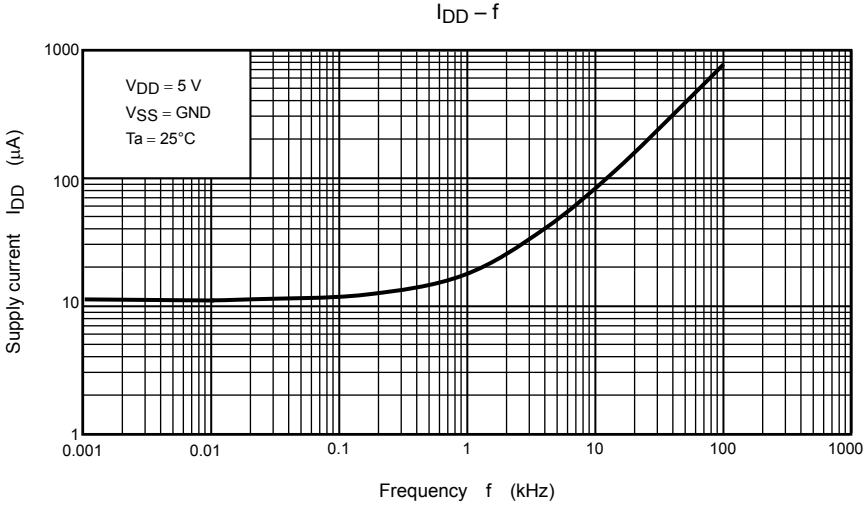
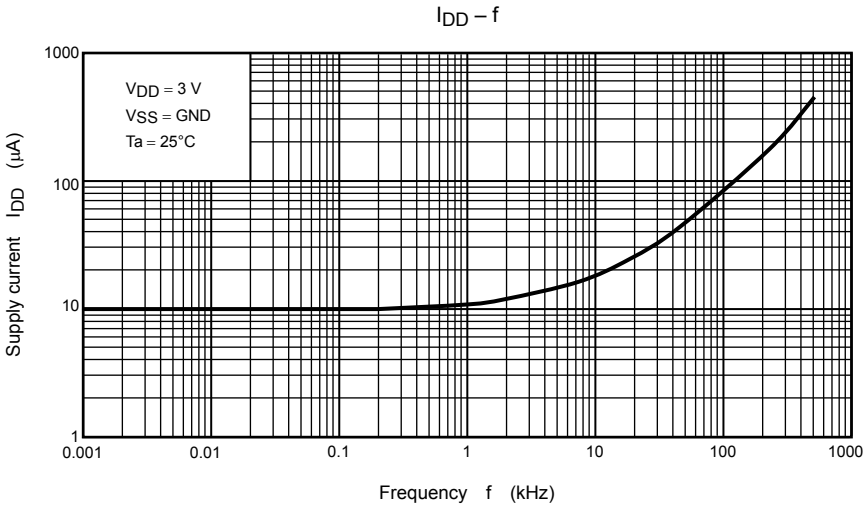

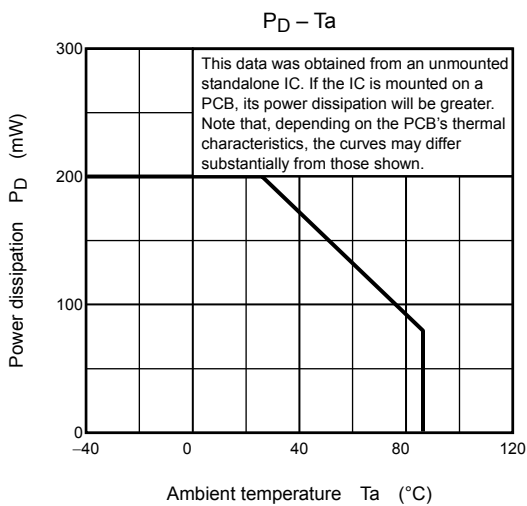
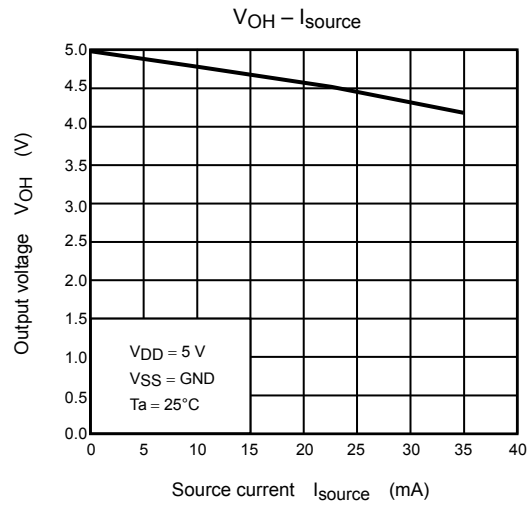
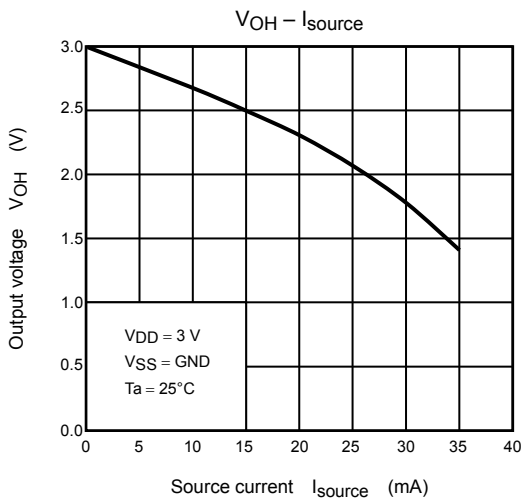
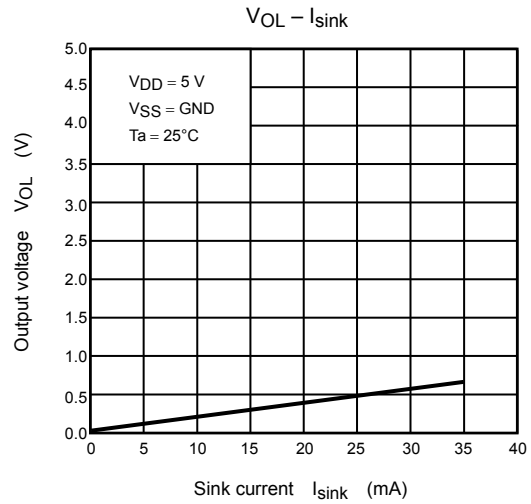
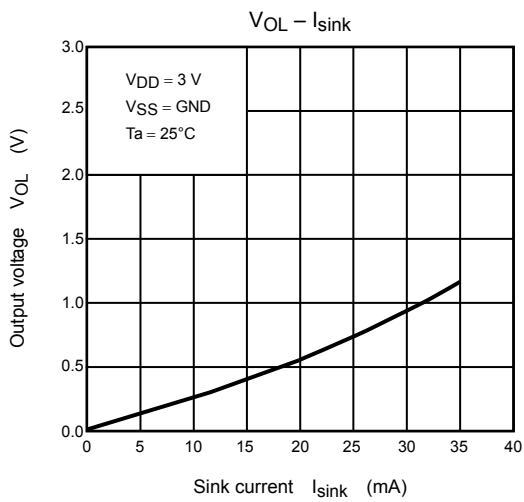

Package Dimensions

SSOP5-P-0.95

Unit : mm

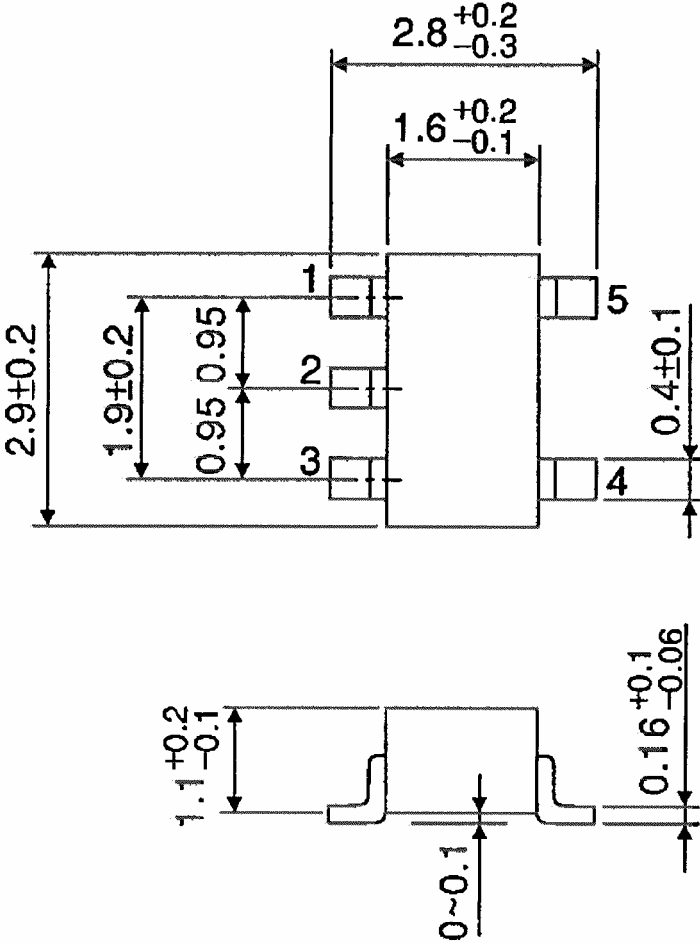

Weight: 0.014 g (typ.)

Package Dimensions

SSOP5-P-0.65A

Unit : mm

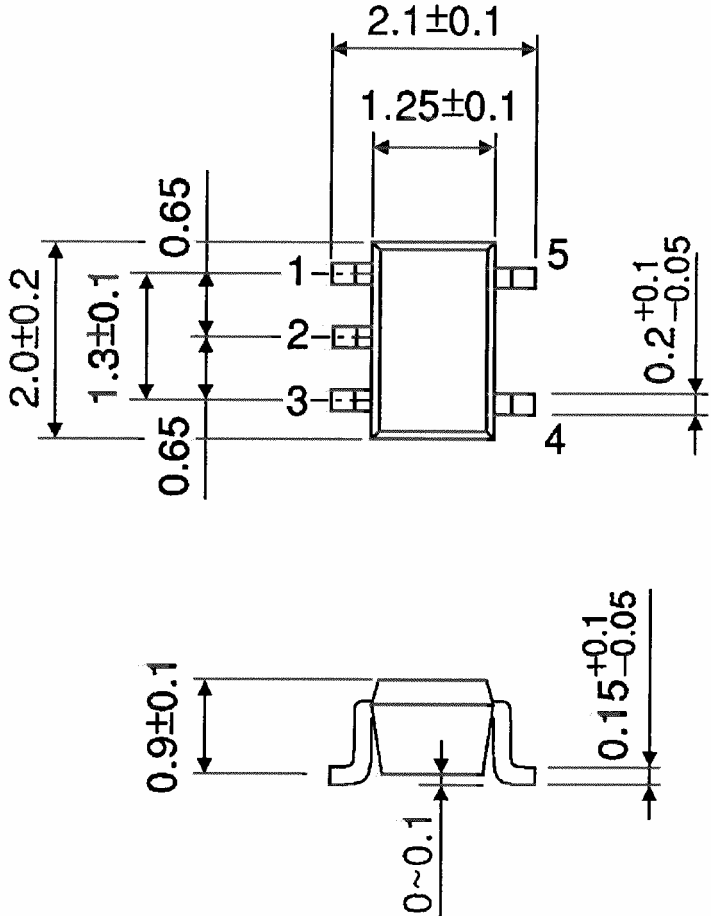

Weight: 0.006 g (typ.)

Package Dimensions

SON5-P-0.50

Unit : mm

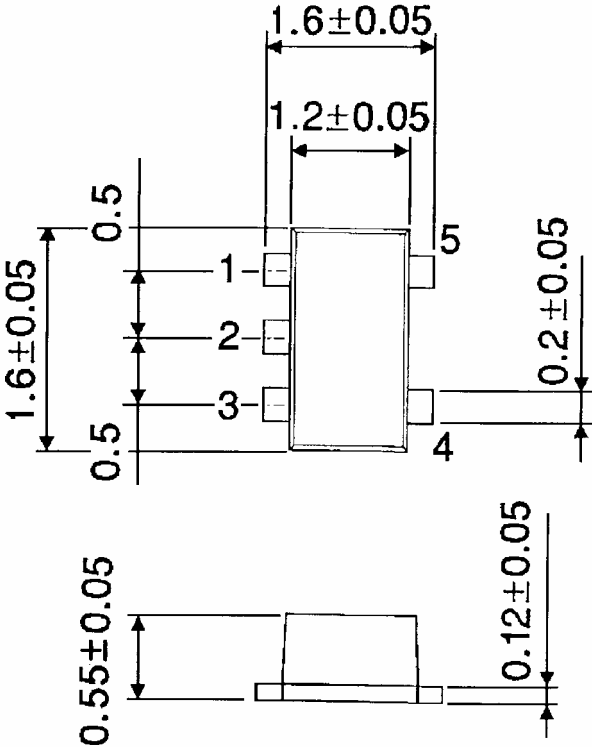

Weight: 0.003 g (typ.)

RESTRICTIONS ON PRODUCT USE

20070701-EN GENERAL

- The information contained herein is subject to change without notice.
- TOSHIBA is continually working to improve the quality and reliability of its products. Nevertheless, semiconductor devices in general can malfunction or fail due to their inherent electrical sensitivity and vulnerability to physical stress. It is the responsibility of the buyer, when utilizing TOSHIBA products, to comply with the standards of safety in making a safe design for the entire system, and to avoid situations in which a malfunction or failure of such TOSHIBA products could cause loss of human life, bodily injury or damage to property.
In developing your designs, please ensure that TOSHIBA products are used within specified operating ranges as set forth in the most recent TOSHIBA products specifications. Also, please keep in mind the precautions and conditions set forth in the "Handling Guide for Semiconductor Devices," or "TOSHIBA Semiconductor Reliability Handbook" etc.
- The TOSHIBA products listed in this document are intended for usage in general electronics applications (computer, personal equipment, office equipment, measuring equipment, industrial robotics, domestic appliances, etc.). These TOSHIBA products are neither intended nor warranted for usage in equipment that requires extraordinarily high quality and/or reliability or a malfunction or failure of which may cause loss of human life or bodily injury ("Unintended Usage"). Unintended Usage include atomic energy control instruments, airplane or spaceship instruments, transportation instruments, traffic signal instruments, combustion control instruments, medical instruments, all types of safety devices, etc.. Unintended Usage of TOSHIBA products listed in this document shall be made at the customer's own risk.
- The products described in this document shall not be used or embedded to any downstream products of which manufacture, use and/or sale are prohibited under any applicable laws and regulations.
- The information contained herein is presented only as a guide for the applications of our products. No responsibility is assumed by TOSHIBA for any infringements of patents or other rights of the third parties which may result from its use. No license is granted by implication or otherwise under any patents or other rights of TOSHIBA or the third parties.
- Please contact your sales representative for product-by-product details in this document regarding RoHS compatibility. Please use these products in this document in compliance with all applicable laws and regulations that regulate the inclusion or use of controlled substances. Toshiba assumes no liability for damage or losses occurring as a result of noncompliance with applicable laws and regulations.