

TOSHIBA InGaA/P LED

## TLGU62T(F), TLPGU62T(F)

### Panel Circuit Indicator

- Lead(Pb)-free products (lead: Sn-Ag-Cu)
- 3mm package
- InGaA/P technology
- All plastic mold type
- Transparent lens
- Colors: Green, pure green
- High intensity light emission
- Excellent low current light output
- Applications: Backlight, Safety equipment, Indicator

Unit in mm

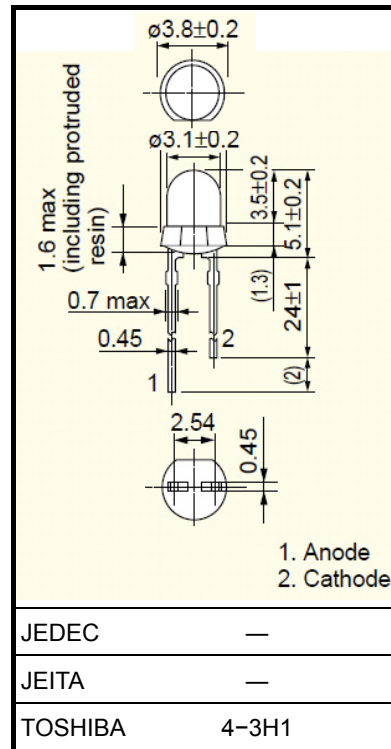

### Lineup

Product Name	Color	Material
TLGU62T(F)	Green	InGaA/P
TLPGU62T(F)	Pure green	

Weight: 0.14 g(Typ.)

### Absolute Maximum Ratings (Ta = 25°C)

Product Name	Forward Current I <sub>F</sub> (mA)	Reverse Voltage V <sub>R</sub> (V)	Power Dissipation P <sub>D</sub> (mW)	Operating Temperature T <sub>opr</sub> (°C)	Storage Temperature T <sub>stg</sub> (°C)
TLGU62T(F)	30	4	72	-40~100	-40~120
TLPGU62T(F)	30	4	72		

Note: Using continuously under heavy loads (e.g. the application of high temperature/current/voltage and the significant change in temperature, etc.) may cause this product to decrease in the reliability significantly even if the operating conditions (i.e. operating temperature/current/voltage, etc.) are within the absolute maximum ratings.

Please design the appropriate reliability upon reviewing the Toshiba Semiconductor Reliability Handbook ("Handling Precautions"/"Derating Concept and Methods") and individual reliability data (i.e. reliability test report and estimated failure rate, etc).

**Electrical and Optical Characteristics (Ta = 25°C)**

Product Name	Typ. Emission Wavelength				Luminous Intensity I <sub>V</sub>			Forward Voltage V <sub>F</sub>			Reverse Current I <sub>R</sub>	
	λ <sub>d</sub>	λ <sub>P</sub>	Δλ	I <sub>F</sub>	Min	Typ.	I <sub>F</sub>	Typ.	Max	I <sub>F</sub>	Max	V <sub>R</sub>
TLGU62T(F)	571	(574)	17	20	27.2	70	20	2.1	2.4	20	50	4
TLPGU62T(F)	558	(562)	14	20	8.5	25	20	2.1	2.4	20	50	4
Unit	nm			mA	mcd		mA	V		mA	μA	V

**Precautions**

Please be careful of the following:

- Soldering temperature: 260°C max, soldering time: 3 s max  
(soldering portion of lead: up to 1.6 mm from the body of the device)
- If the lead is formed, the lead should be formed up to 1.6 mm from the body of the device without forming stress to the resin. Soldering should be performed after lead forming.
- This visible LED lamp also emits some IR light.  
If a photodetector is located near the LED lamp, please ensure that it will not be affected by this IR light.

## TLGU62T(F)

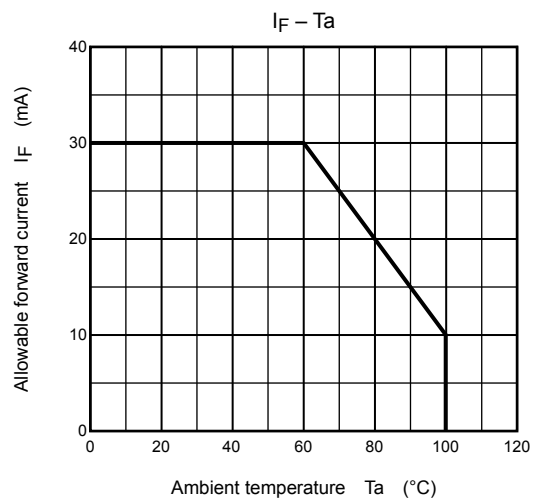
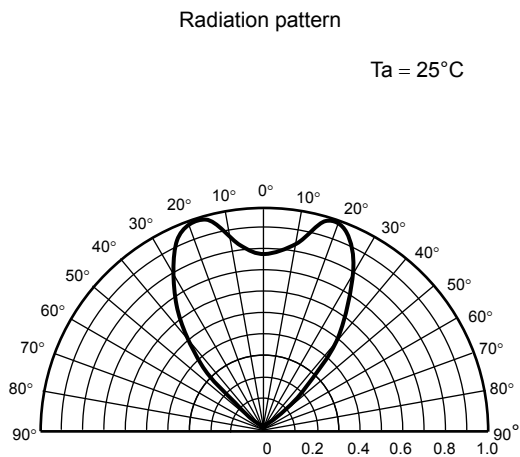
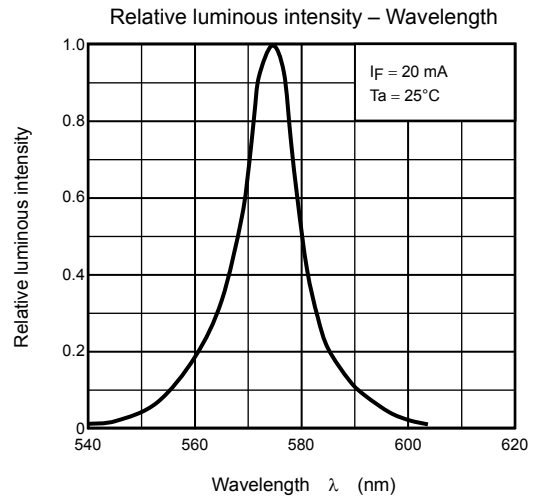
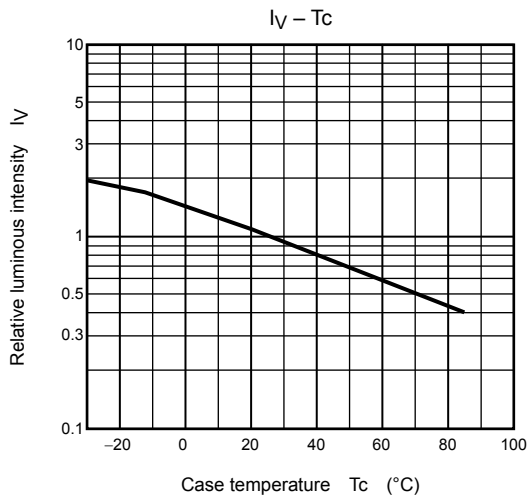
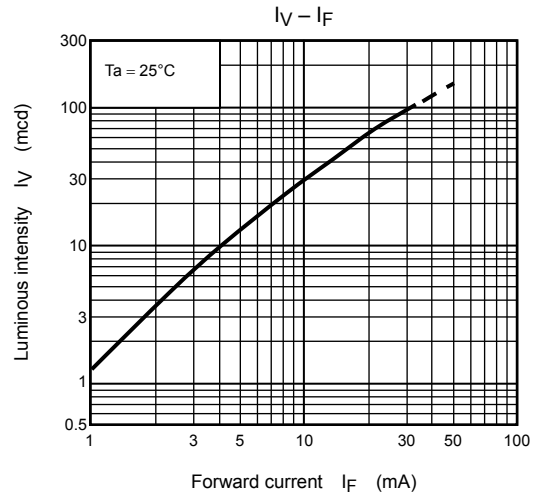
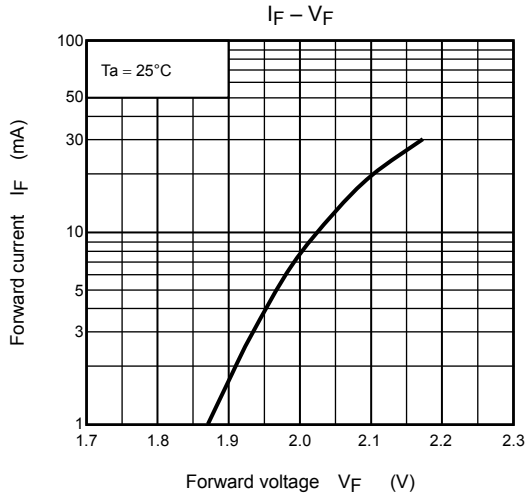

## TLPGU62T(F)

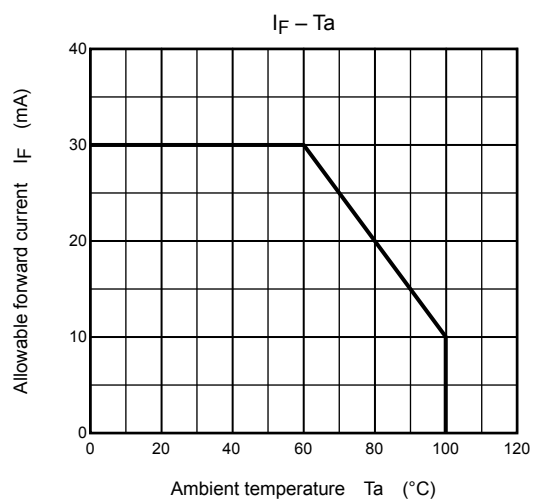
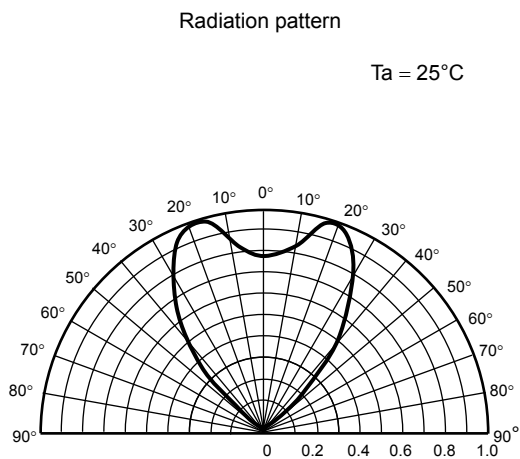
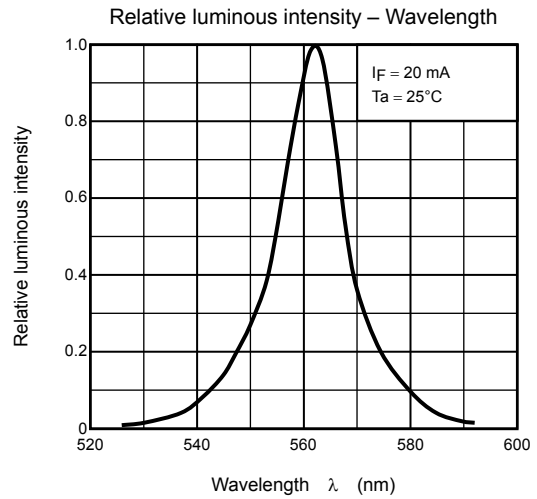
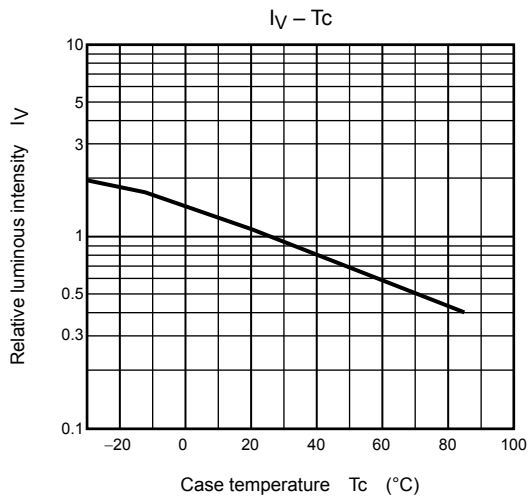
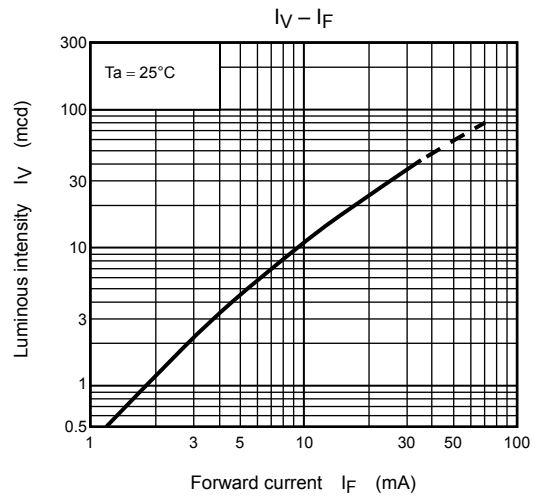
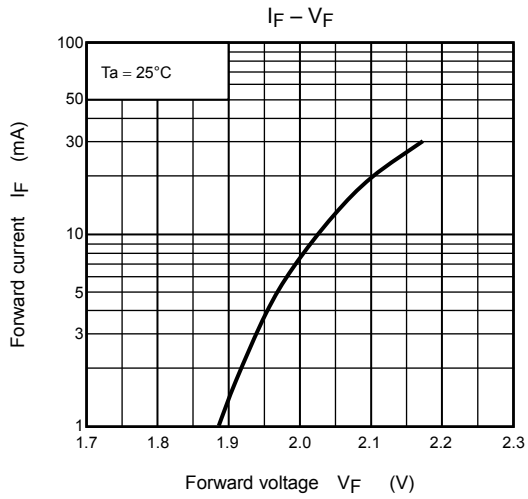

**RESTRICTIONS ON PRODUCT USE**

20070701-EN

- The information contained herein is subject to change without notice.
- TOSHIBA is continually working to improve the quality and reliability of its products. Nevertheless, semiconductor devices in general can malfunction or fail due to their inherent electrical sensitivity and vulnerability to physical stress. It is the responsibility of the buyer, when utilizing TOSHIBA products, to comply with the standards of safety in making a safe design for the entire system, and to avoid situations in which a malfunction or failure of such TOSHIBA products could cause loss of human life, bodily injury or damage to property.  
In developing your designs, please ensure that TOSHIBA products are used within specified operating ranges as set forth in the most recent TOSHIBA products specifications. Also, please keep in mind the precautions and conditions set forth in the "Handling Guide for Semiconductor Devices," or "TOSHIBA Semiconductor Reliability Handbook" etc.
- The TOSHIBA products listed in this document are intended for usage in general electronics applications (computer, personal equipment, office equipment, measuring equipment, industrial robotics, domestic appliances, etc.). These TOSHIBA products are neither intended nor warranted for usage in equipment that requires extraordinarily high quality and/or reliability or a malfunction or failure of which may cause loss of human life or bodily injury ("Unintended Usage"). Unintended Usage include atomic energy control instruments, airplane or spaceship instruments, transportation instruments, traffic signal instruments, combustion control instruments, medical instruments, all types of safety devices, etc.. Unintended Usage of TOSHIBA products listed in this document shall be made at the customer's own risk.
- The products described in this document shall not be used or embedded to any downstream products of which manufacture, use and/or sale are prohibited under any applicable laws and regulations.
- The information contained herein is presented only as a guide for the applications of our products. No responsibility is assumed by TOSHIBA for any infringements of patents or other rights of the third parties which may result from its use. No license is granted by implication or otherwise under any patents or other rights of TOSHIBA or the third parties.
- GaAs(Gallium Arsenide) is used in this product. The dust or vapor is harmful to the human body. Do not break, cut, crush or dissolve chemically.
- Please contact your sales representative for product-by-product details in this document regarding RoHS compatibility. Please use these products in this document in compliance with all applicable laws and regulations that regulate the inclusion or use of controlled substances. Toshiba assumes no liability for damage or losses occurring as a result of noncompliance with applicable laws and regulations.