

## TOSHIBA LED Lamps

### TLRU1002A(T02), TLSU1002A(T02), TLOU1002A(T02), TLAU1002A(T02), TLYU1002A(T02), TLGU1002A(T02), TLPGU1002A(T02)

#### Panel Circuit Indicator

- Surface-mount devices
- 2.0 (L) × 1.25 (W) × 1.1 (H) mm
- InGaAlP LEDs
- It can be manufactured high-luminosity of equipment or reduce of electric power consumption by change in the high-luminosity LED from general-luminosity one.
- Colors: red, orange, amber, yellow, green, pure green
- Pb-free reflow soldering is possible
- Applications:
  - Backlighting source for battery-powered equipment
  - Pilot light for compact equipment
  - Low-power electronic equipment, etc.
- Standard embossed tape packing: T02 (3000/reel)  
8-mm tape reel

#### Color and Material

Product Name	Color	Material
TLRU1002A	Red	InGaAlP
TLSU1002A	Red	
TLOU1002A	Orange	
TLAU1002A	Amber	
TLYU1002A	Yellow	
TLGU1002A	Green	
TLPGU1002A	Pure Green	

Unit: mm

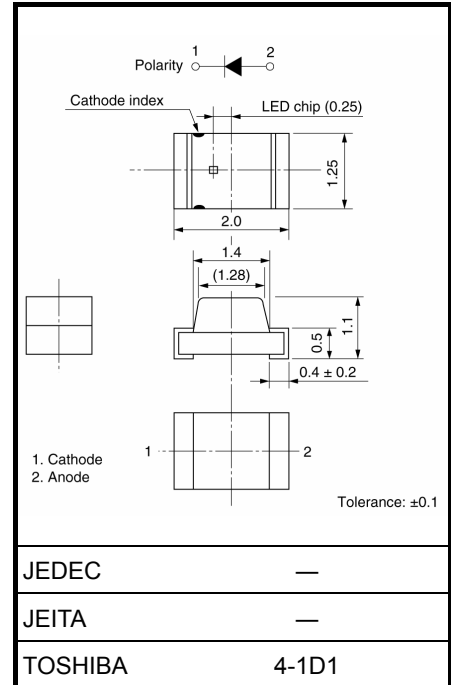

Weight: 0.002 g (typ.)

### Maximum Ratings (Ta = 25°C)

Product Name	Forward Current I <sub>F</sub> (mA) Please see Note 1	Reverse Voltage V <sub>R</sub> (V)	Power Dissipation P <sub>D</sub> (mW)	Operation Temperature T <sub>opr</sub> (°C)	Storage Temperature T <sub>stg</sub> (°C)
TLRU1002A	25	4	60	-40~85	-40~100
TLSU1002A					
TLOU1002A					
TLAU1002A			62.5		
TLYU1002A					
TLGU1002A					
TLPGU1002A					

Note 1: Forward current derating

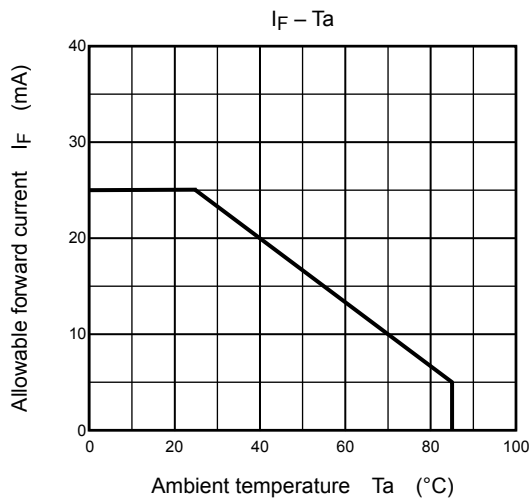

### Electrical Characteristics (Ta = 25°C)

Product Name	Forward Voltage V <sub>F</sub>			Reverse Current I <sub>R</sub>		
	Min	Typ.	Min	I <sub>F</sub>	Max	V <sub>R</sub>
TLRU1002A	1.6	2.0	2.4	20	50	4
TLSU1002A	1.6	2.0	2.4			
TLOU1002A	1.6	2.1	2.5			
TLAU1002A	1.6	2.1	2.5			
TLYU1002A	1.6	2.1	2.5			
TLGU1002A	1.6	2.1	2.5			
TLPGU1002A	1.6	2.1	2.5			
Unit	V			mA	μA	V

## Optical Characteristics-1 (Ta = 25°C)

Product Name	Luminous Intensity I <sub>v</sub>				Available I <sub>v</sub> rank Please see Note 2
	Min	Typ.	Max	I <sub>F</sub>	
TLRU1002A	4.76	45	—	20	H / J / K / L
TLSU1002A	27.2	60	—	20	L / M / N / P
TLOU1002A	27.2	78	—	20	L / M / N / P
TLAU1002A	8.5	30	—	20	J / K / L / M
TLYU1002A	8.5	30	—	20	J / K / L / M
TLGU1002A	8.5	30	—	20	J / K / L / M
TLPGU1002A	1.53	6	—	20	F / G / H / J
Unit	mcd	mcd	mcd	mA	

Note 2: The specification on the above table is used for I<sub>v</sub> classification of LEDs in Toshiba facility.  
Each reel includes the same rank LEDs. Let the delivery ratio of each rank be unquestioned.

Rank	Luminous Intensity I <sub>v</sub>	
	Min	Min
F	1.53	4.14
G	2.72	7.36
H	4.76	12.9
J	8.5	23
K	15.3	41.4
L	27.2	73.6
M	47.6	129
N	85	230
P	153	414
Unit	mcd	mcd

## Optical Characteristics-2 (Ta = 25°C)

Product Name	Emission Spectrum							
	Peak Emission Wavelength λ <sub>p</sub>			Δλ Typ.	Dominant Wavelength λ <sub>d</sub>			I <sub>F</sub>
	Min	Typ.	Max		Min	Typ.	Max	
TLRU1002A	—	644	—	15	624	630	638	20
TLSU1002A	—	636	—	17	617	623	631	
TLOU1002A	—	612	—	15	599	605	613	
TLAU1002A	—	596	—	13	585	592	599	
TLYU1002A	—	590	—	15	580	587	595	
TLGU1002A	—	574	—	13	565	571	576	
TLPGU1002A	—	562	—	13	—	557	564	
Unit	nm			nm	nm			mA

## The cautions

- This visible LED lamp also emits some IR light.  
If a photodetector is located near the LED lamp, please ensure that it will not be affected by the IR light.
- This product is designed as a general display light source usage, and it has applied the measurement standard that matched with the sensitivity of human's eyes. Therefore, it is not intended for usage of functional application (ex. Light source for sensor, optical communication and etc) except general display light source.

**TLRU1002A**

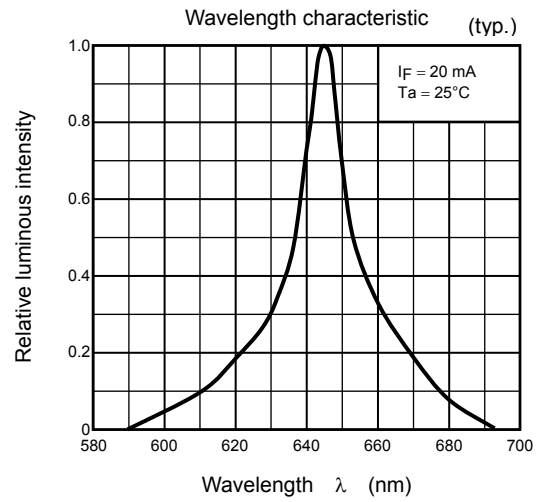
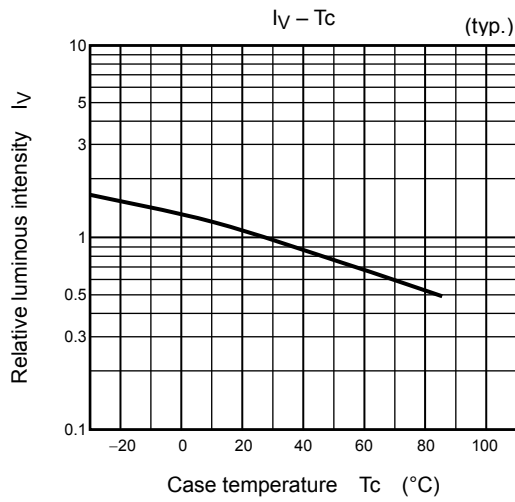
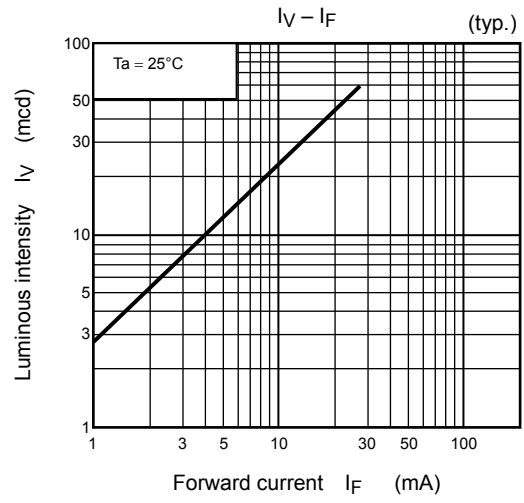
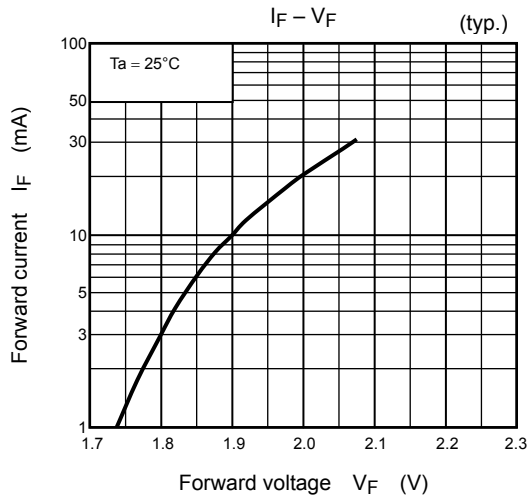

### TLSU1002A

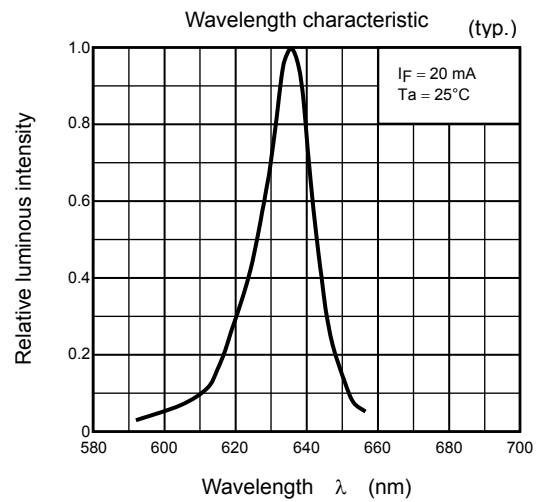
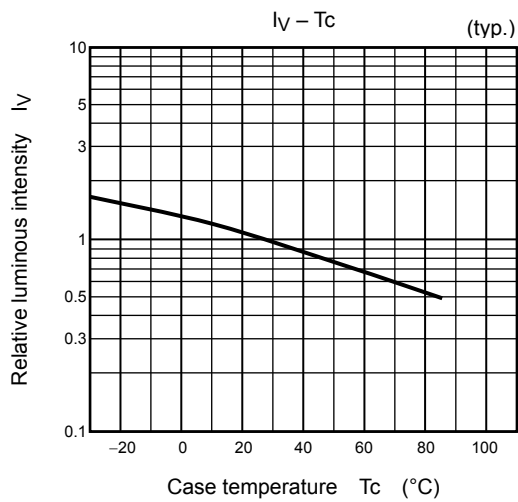
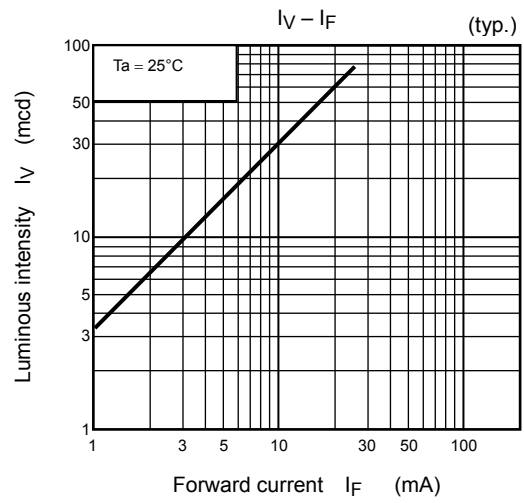
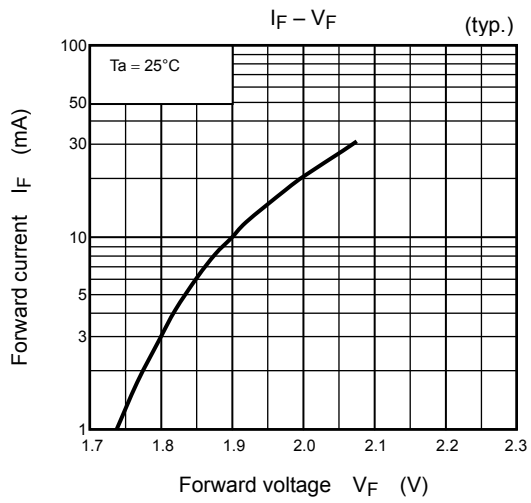

**TLOU1002A**

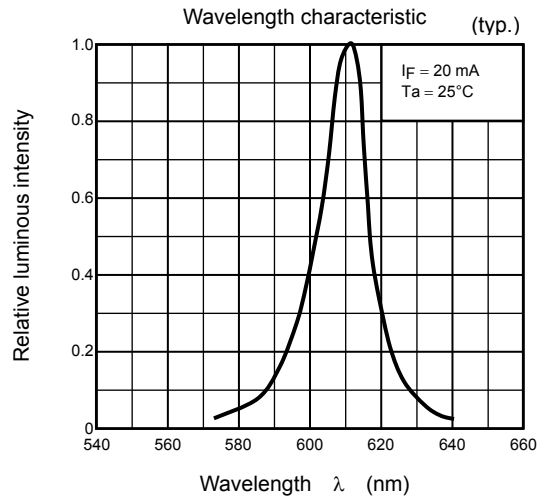
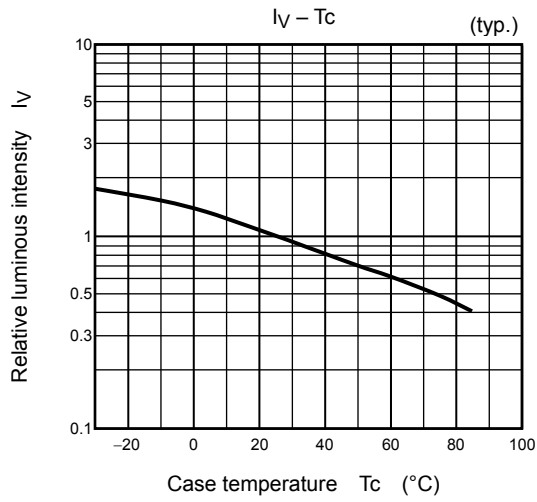
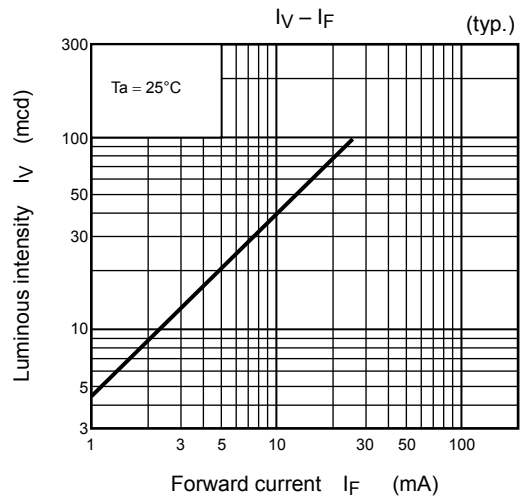
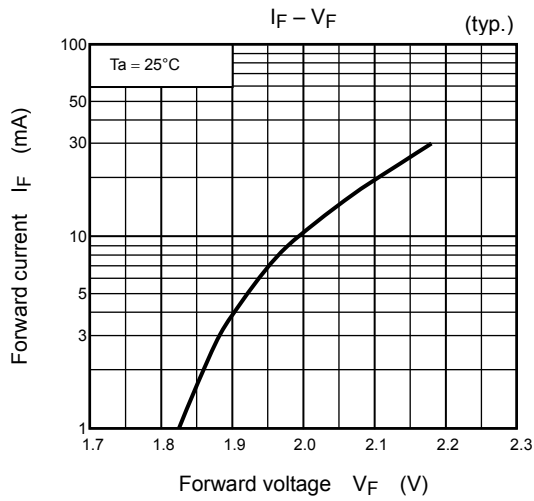

**TLAU1002A**

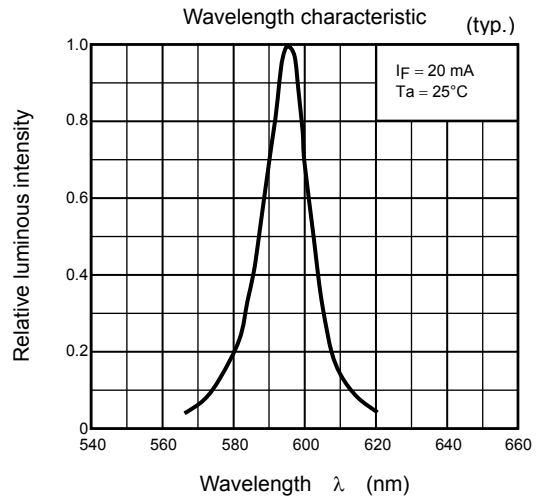
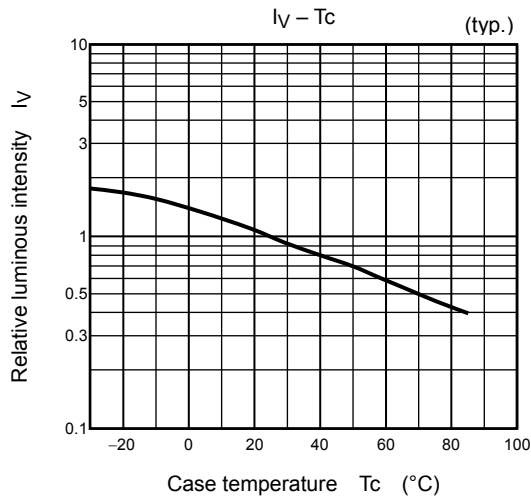
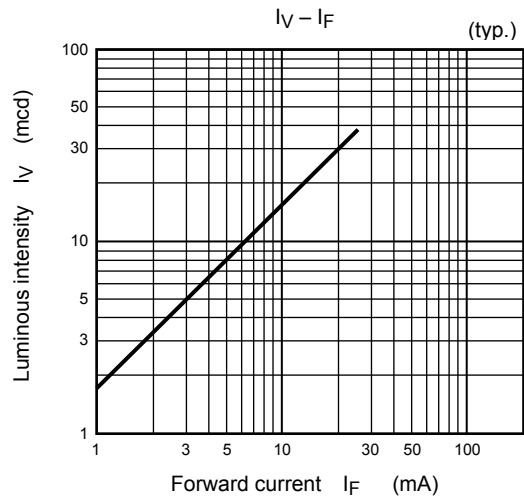
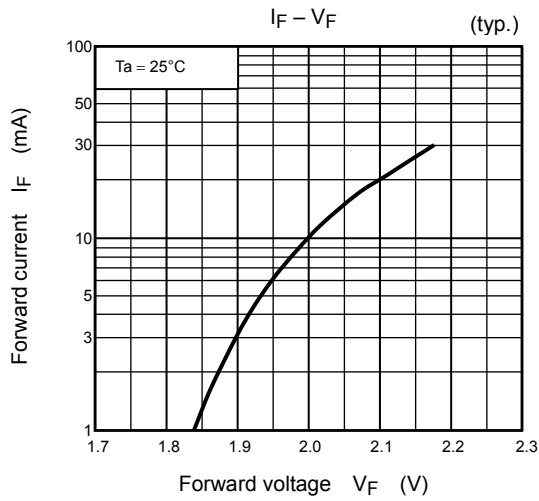

**TLYU1002A**

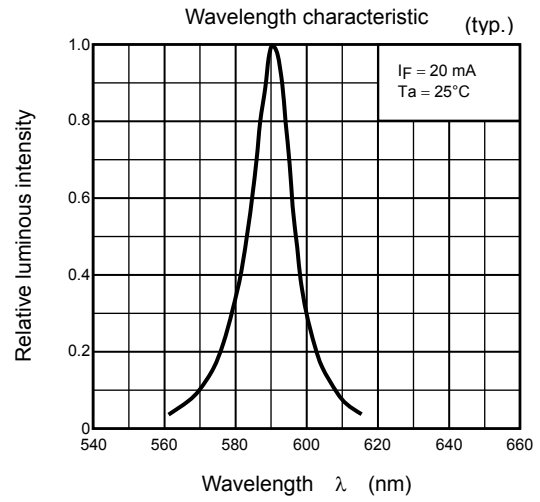
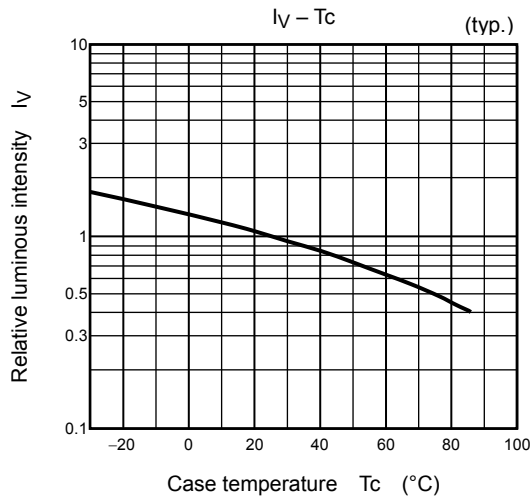
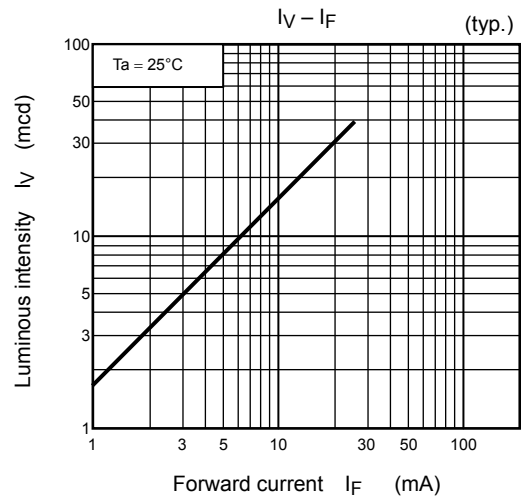
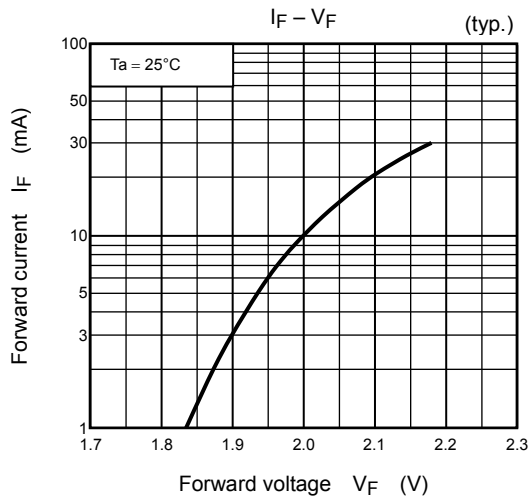



**TLGU1002A**

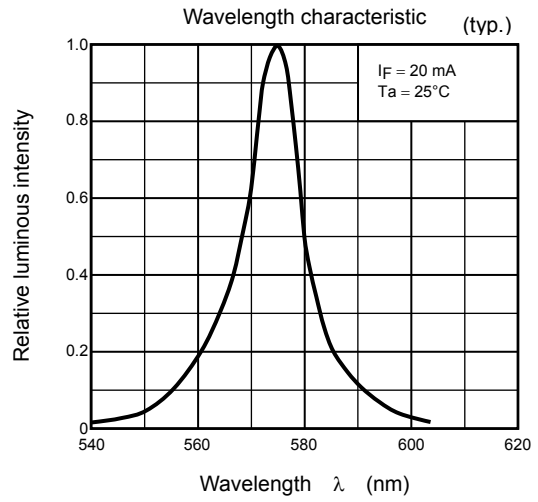
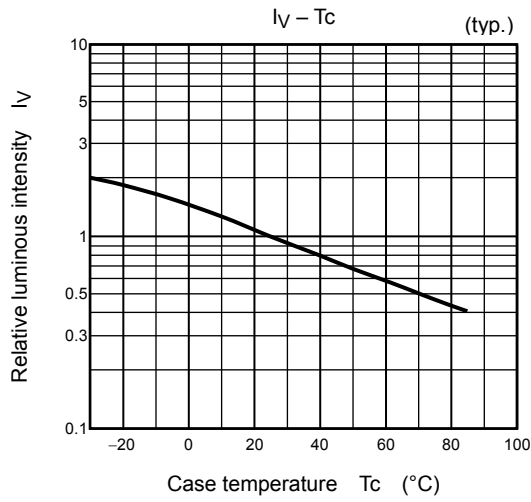
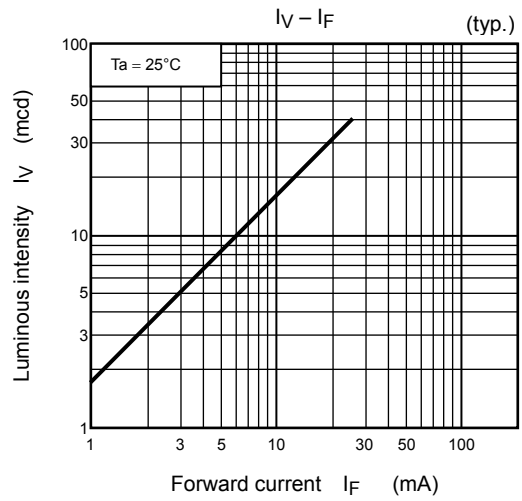
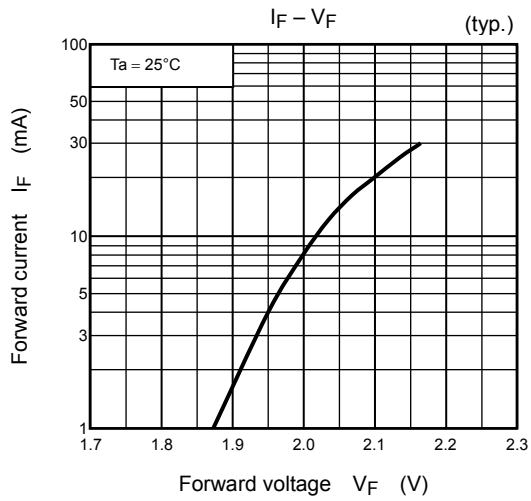

**TLPGU1002A**

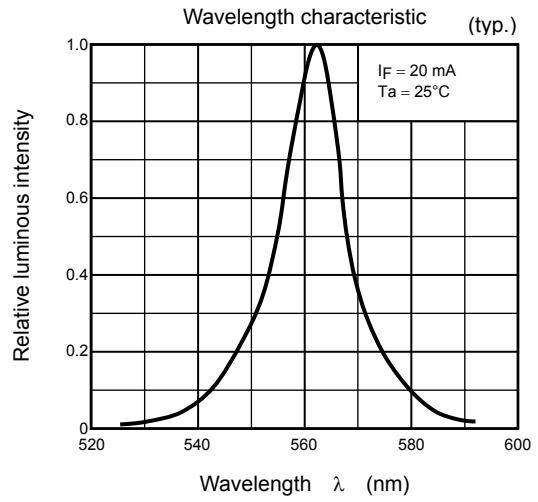
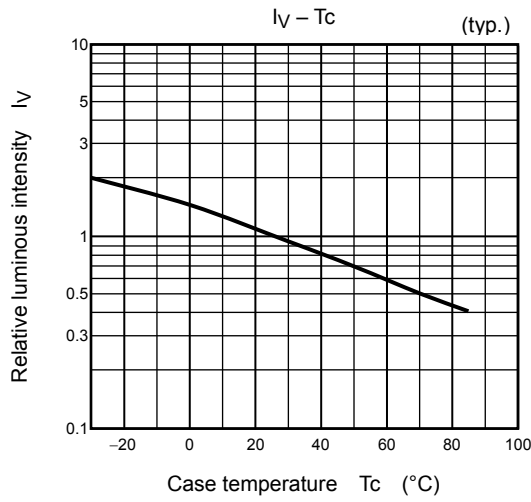
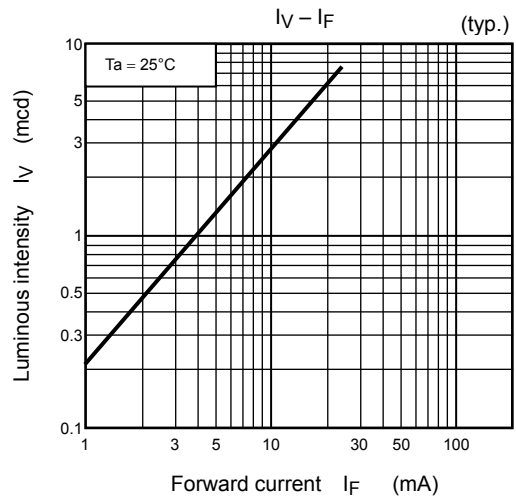
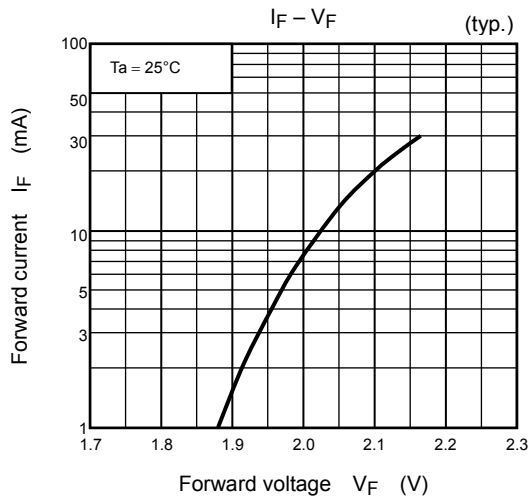

**Radiation Pattern**

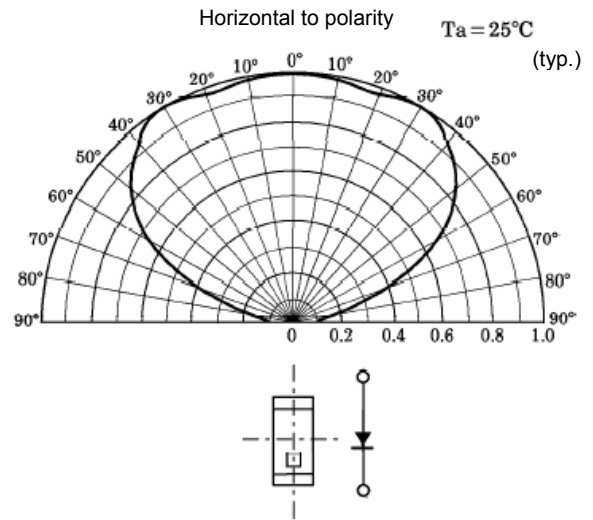
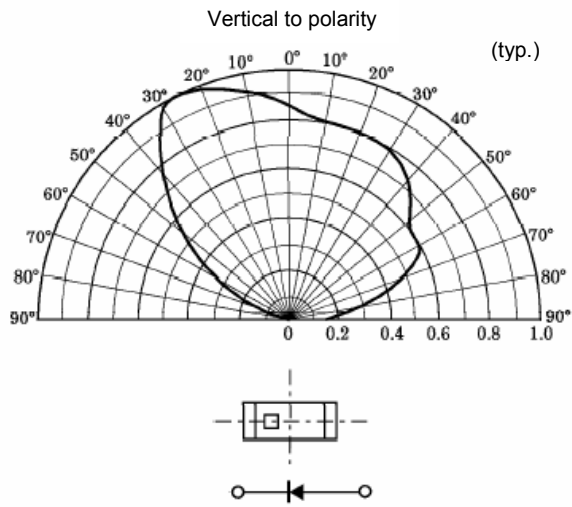

## Packaging

These LED devices are packed in an aluminum envelope with a silica gel and a moisture indicator to avoid moisture absorption. The optical characteristics of the devices may be affected by exposure to moisture in the air before soldering and they should therefore be stored under the following conditions:

1. This moisture proof bag may be stored unopened within 12 months at the following conditions.  
 Temperature: 5°C~30°C  
 Humidity: 90% (max)
2. After opening the moisture proof bag, the devices should be assembled within 168 hours in an environment of 5°C to 30°C/70% RH or below.  
 When performing lead(Pb)-free soldering, the devices should be assembled within 72 hours in an environment of 5°C to 30°C/70% RH or below.
3. If upon opening, the moisture indicator card shows humidity 30% or above (Color of indication changes to pink) or the expiration date has passed, the devices should be baked in taping with reel.  
 After baking, use the baked devices within 72 hours, but perform baking only once.  
 Baking conditions: 60±5°C, for 12 to 24 hours.  
 Expiration date: 12 months from sealing date, which is imprinted on the same side as this label affixed.
4. Repeated baking can cause the peeling strength of the taping to change, then leads to trouble in mounting.  
 Furthermore, prevent the devices from being destructed against static electricity for baking of it.
5. If the packing material of laminate would be broken, the air tightness would deteriorate. Therefore, do not throw or drop the packed devices.

## Mounting Method

### Soldering

- Reflow soldering (example)

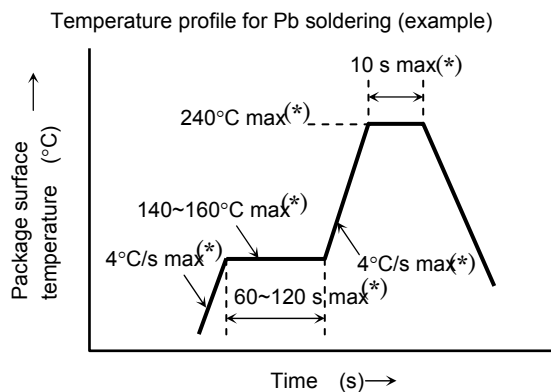

- The products are evaluated using above reflow soldering conditions. No additional test is performed exceed the condition (i.e. the condition more than (\*)MAX values) as a evaluation. Please perform reflow soldering under the above conditions.
- Please perform the first reflow soldering with reference to the above temperature profile and within 168 h of opening the package.
- Second reflow soldering  
 In case of second reflow soldering should be performed within 168 h of the first reflow under the above conditions.  
 Storage conditions before the second reflow soldering: 30°C, 70% RH (max)
- Make any necessary soldering corrections manually.  
 (only once at each soldering point)  
 Soldering iron: 25 W  
 Temperature : 300°C or less  
 Time : within 3 s
- Do not perform wave soldering.

- Reflow soldering (example)

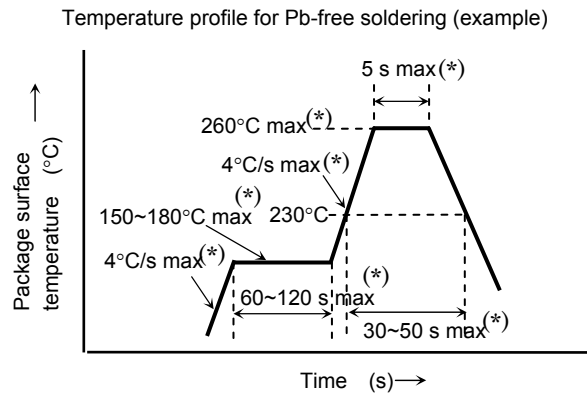

- The products are evaluated using above reflow soldering conditions. No additional test is performed exceed the condition (i.e. the condition more than (\*)MAX values) as a evaluation. Please perform reflow soldering under the above conditions.
- Please perform the first reflow soldering with reference to the above temperature profile and within 72 h of opening the package.
- Second reflow soldering  
In case of second reflow soldering should be performed within 72 h of the first reflow under the above conditions.  
Storage conditions before the second reflow soldering: 30°C, 70% RH (max)
- Make any necessary soldering corrections manually.  
(only once at each soldering point)  
Soldering iron: 25 W  
Temperature : 300°C or less  
Time : within 3 s
- Do not perform wave soldering.

## Recommended soldering pattern

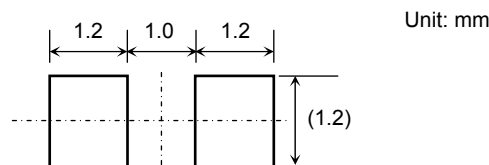

## Cleaning

When cleaning is required after soldering, Toshiba recommends the following cleaning solvents. It is confirmed that these solvents have no effect on semiconductor devices in our dipping test (under the recommended conditions). In selecting the one for your actual usage, please perform sufficient review on washing condition, using condition and etc.

ASAHI CLEAN AK-225AES	: (made by ASAHI GLASS)
KAO CLEAN TROUGH 750H	: (made by KAO)
PINE ALPHA ST-100S	: (made by ARAKAWA CHEMICAL)
TOSHIBA TECHNOCARE (FRW-17, FRW-1, FRV-100)	: (made by GE TOSHIBA SILICONES)

## Precaution when mounting

Do not apply force to the plastic part of the LED under high-temperature conditions.

To avoid damaging the LED plastic, do not apply friction using a hard material.

When installing the PCB in a product, ensure that the device does not come into contact with other components.

## Tape Specifications

### 1. Product number format

The type of package used for shipment is denoted by a symbol suffix after the product number. The method of classification is as below. (However, this method does not apply to products whose electrical/optical characteristics differ from standard Toshiba specifications)

- (1) Tape Type: T02 (4-mm pitch)
- (2) Example

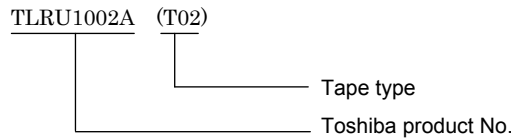

### 2. Handling precautions

Tape material protected against static electricity. However, static electricity may occur depending on quantity of charged static electricity and a device may attach to a tape, or a device may be unstable when peeling a tape cover.

- (a) Since tape materials may accumulate an electrostatic charge, use an ionizer to neutralize the ambient air.
- (b) For transport and temporary storage of devices, use containers (boxes and bags) and jigs that are made of anti-static materials or of materials which dissipate electrostatic charge.

### 3. Tape dimensions

Unit: mm

Symbol	Value	Tolerance
D	1.50	+0.1/-0
E	1.75	±0.1
P <sub>0</sub>	4.00	±0.1
t	0.20	±0.05
F	3.50	±0.05
D <sub>1</sub>	1.10	±0.1

Symbol	Value	Tolerance
P <sub>2</sub>	2.00	±0.05
W	8.00	±0.3
P	4.00	±0.1
A <sub>0</sub>	1.45	±0.1
B <sub>0</sub>	2.25	±0.1
K <sub>0</sub>	1.30	±0.05

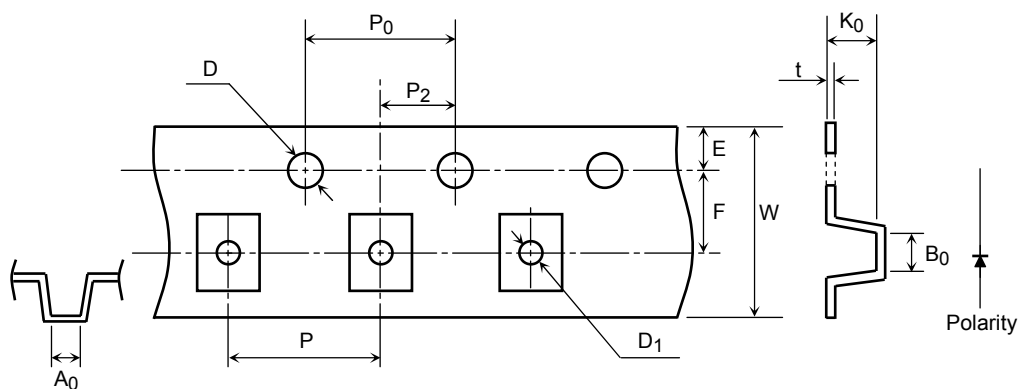

**4. Reel dimensions**

Unit: mm

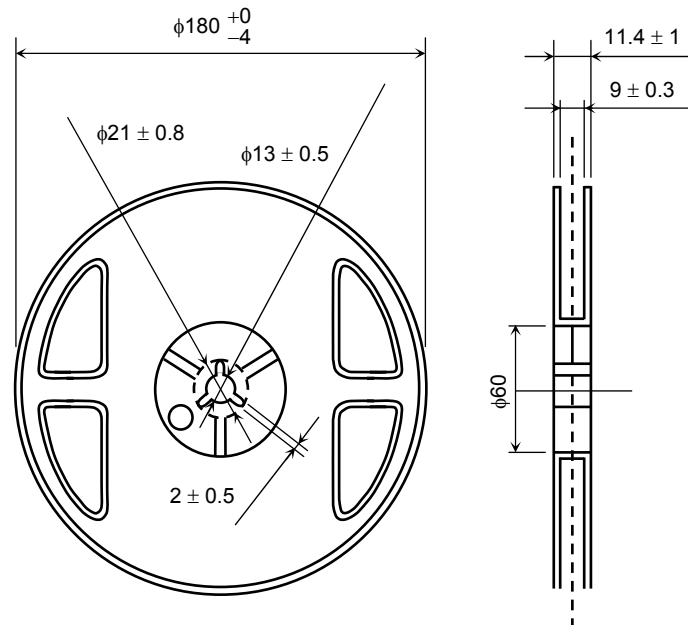

**5. Leader and trailer section of tape**

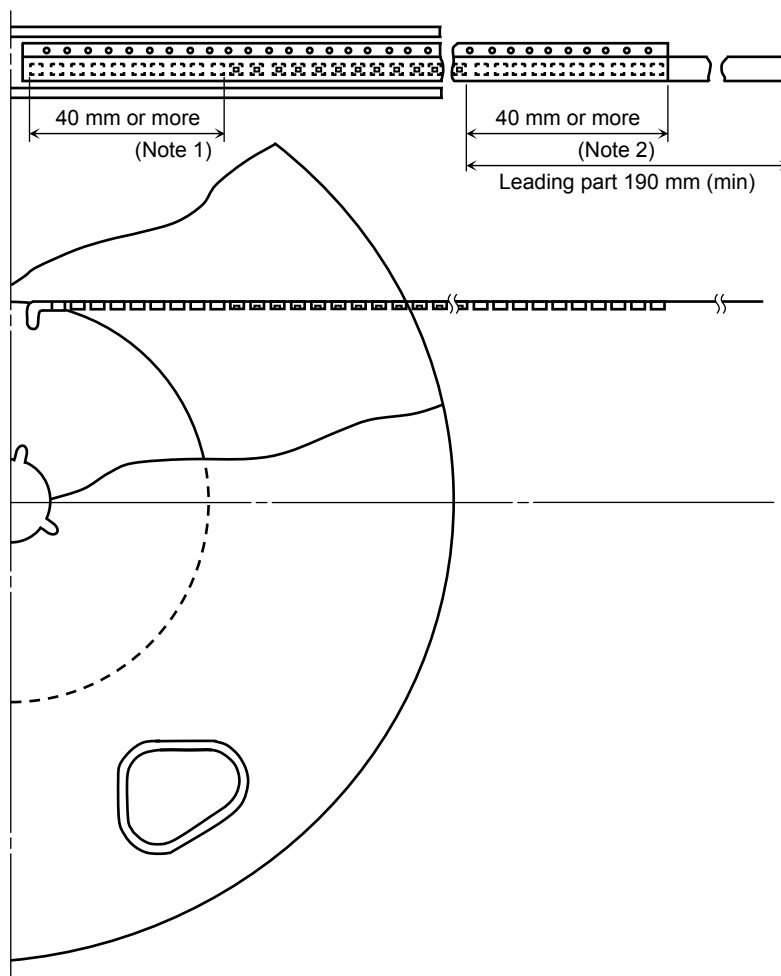

Note 1: Empty trailer section

Note 2: Empty leader section





**RESTRICTIONS ON PRODUCT USE**

20070701-EN

- The information contained herein is subject to change without notice.
- TOSHIBA is continually working to improve the quality and reliability of its products. Nevertheless, semiconductor devices in general can malfunction or fail due to their inherent electrical sensitivity and vulnerability to physical stress. It is the responsibility of the buyer, when utilizing TOSHIBA products, to comply with the standards of safety in making a safe design for the entire system, and to avoid situations in which a malfunction or failure of such TOSHIBA products could cause loss of human life, bodily injury or damage to property.  
In developing your designs, please ensure that TOSHIBA products are used within specified operating ranges as set forth in the most recent TOSHIBA products specifications. Also, please keep in mind the precautions and conditions set forth in the "Handling Guide for Semiconductor Devices," or "TOSHIBA Semiconductor Reliability Handbook" etc.
- The TOSHIBA products listed in this document are intended for usage in general electronics applications (computer, personal equipment, office equipment, measuring equipment, industrial robotics, domestic appliances, etc.). These TOSHIBA products are neither intended nor warranted for usage in equipment that requires extraordinarily high quality and/or reliability or a malfunction or failure of which may cause loss of human life or bodily injury ("Unintended Usage"). Unintended Usage include atomic energy control instruments, airplane or spaceship instruments, transportation instruments, traffic signal instruments, combustion control instruments, medical instruments, all types of safety devices, etc.. Unintended Usage of TOSHIBA products listed in this document shall be made at the customer's own risk.
- The products described in this document shall not be used or embedded to any downstream products of which manufacture, use and/or sale are prohibited under any applicable laws and regulations.
- The information contained herein is presented only as a guide for the applications of our products. No responsibility is assumed by TOSHIBA for any infringements of patents or other rights of the third parties which may result from its use. No license is granted by implication or otherwise under any patents or other rights of TOSHIBA or the third parties.
- GaAs(Gallium Arsenide) is used in this product. The dust or vapor is harmful to the human body. Do not break, cut, crush or dissolve chemically.
- Please contact your sales representative for product-by-product details in this document regarding RoHS compatibility. Please use these products in this document in compliance with all applicable laws and regulations that regulate the inclusion or use of controlled substances. Toshiba assumes no liability for damage or losses occurring as a result of noncompliance with applicable laws and regulations.