

**TO-220**

**Pin Definition:**

1. Base
2. Collector
3. Emitter

**PRODUCT SUMMARY**

<b><math>V_{CEO}</math></b>	400V
<b><math>V_{CBO}</math></b>	700V
<b><math>I_C</math></b>	4A
<b><math>V_{CE(SAT)}</math></b>	1.5V @ $I_C / I_B = 2.5A / 0.5A$

**Features**

- High Voltage
- High Speed Switching

**Structure**

- Silicon Triple Diffused Type
- NPN Silicon Transistor
- Integrated Antiparallel Collector-Emitter Diode

**Ordering Information**

Part No.	Package	Packing
TSC128DCZ C0	TO-220	50pcs / Tube

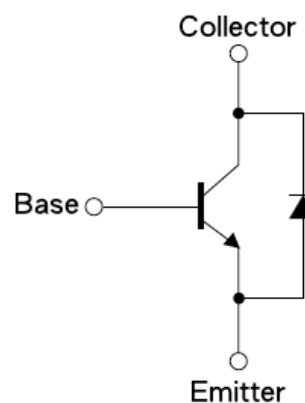
**Block Diagram**

**Absolute Maximum Rating** ( $T_a = 25^\circ\text{C}$  unless otherwise noted)

Parameter	Symbol	Limit	Unit
Collector-Base Voltage	$V_{CBO}$	700V	V
Collector-Emitter Voltage	$V_{CEO}$	400V	V
Emitter-Base Voltage	$V_{EBO}$	9	V
Collector Current	$I_C$	4	A
Collector Peak Current ( $t_p < 5\text{ms}$ )	$I_{CM}$	8	A
Base Current	$I_B$	2	A
Base Peak Current ( $t_p < 5\text{ms}$ )	$I_{BM}$	4	A
Total Dissipation	$P_{tot}$	70	W
Maximum Operating Junction Temperature	$T_J$	+150	$^\circ\text{C}$
Storage Temperature Range	$T_{STG}$	-65 to +150	$^\circ\text{C}$

**Thermal Performance**

Parameter	Symbol	Limit	Unit
Junction to Case Thermal Resistance	$R_{\theta JC}$	1.78	$^\circ\text{C/W}$
Junction to Ambient Thermal Resistance	$R_{\theta JA}$	62.5	$^\circ\text{C/W}$

**Electrical Specifications** ( $T_a = 25^\circ\text{C}$  unless otherwise noted)

Parameter	Conditions	Symbol	Min	Typ	Max	Unit
<b>Static</b>						
Collector-Base Voltage	$I_C = 1\text{mA}, I_B = 0$	$BV_{CBO}$	700	--	--	V
Collector-Emitter Breakdown Voltage	$I_C = 10\text{mA}, I_E = 0$	$BV_{CEO}$	400	--	--	V
Emitter-Base Breakdown Voltage	$I_E = 1\text{mA}, I_C = 0$	$BV_{EBO}$	9	--	--	V
Collector Cutoff Current	$V_{CB} = 700\text{V}, I_E = 0$	$I_{CBO}$	--	--	100	$\mu\text{A}$
Collector Cutoff Current	$V_{CE} = 400\text{V}, I_B = 0$	$I_{CEO}$	--	--	250	$\mu\text{A}$
Emitter Cutoff Current	$V_{EB} = 7\text{V}, I_C = 0$	$I_{EBO}$	--	--	10	$\mu\text{A}$
Collector-Emitter Saturation Voltage	$I_C = 0.5\text{A}, I_B = 0.1\text{A}$	$V_{CE(SAT)1}$	--	--	0.7	V
	$I_C = 1\text{A}, I_B = 0.2\text{A}$	$V_{CE(SAT)2}$	--	--	1	
	$I_C = 2.5\text{A}, I_B = 0.5\text{A}$	$V_{CE(SAT)3}$	--	--	1.5	
	$I_C = 4\text{A}, I_B = 1\text{A}$	$V_{CE(SAT)4}$	--	0.9	--	
Base-Emitter Saturation Voltage	$I_C = 0.5\text{A}, I_B = 0.1\text{A}$	$V_{BE(SAT)1}$	--	--	1.1	V
	$I_C = 1\text{A}, I_B = 0.2\text{A}$	$V_{BE(SAT)2}$	--	--	1.2	
	$I_C = 2.5\text{A}, I_B = 0.5\text{A}$	$V_{BE(SAT)3}$	--	--	1.3	
DC Current Gain	$V_{CE} = 5\text{V}, I_C = 10\text{mA}$	Hfe	10	--	--	
	$V_{CE} = 5\text{V}, I_C = 2\text{A}$		12	--	32	
	$V_{CE} = 5\text{V}, I_C = 2.5\text{A}$		8	--	--	
Forward Voltage Drop	$I_f = 2\text{A}$	Vf	--	--	2	V
Turn On Time	$V_{CC} = 250\text{V}, I_C = 2\text{A}$	$t_{ON}$	--	--	0.6	$\mu\text{S}$
Storage Time	$I_{B1} = I_{B2} = 0.4\text{A}, t_p = 25\mu\text{S}$	$t_{STG}$	2.5	3.0	3.5	$\mu\text{S}$
Fall Time	Duty Cycle < 1%	$t_f$	--	0.2	0.3	$\mu\text{S}$

 Notes: Pulsed duration = 300 $\mu\text{S}$ , duty cycle  $\leq 2\%$

**Electrical Characteristics Curve** ( $T_a = 25^\circ\text{C}$ , unless otherwise noted)

**Figure 1. Static Characteristics**

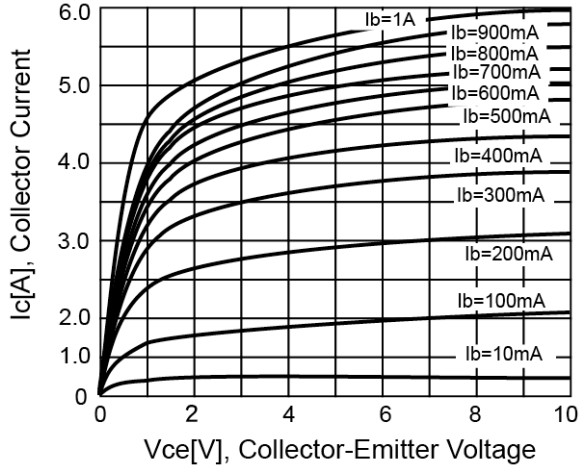

**Figure 2. DC Current Gain**

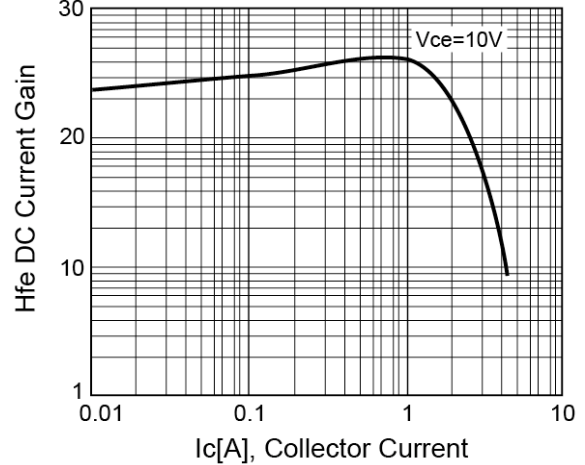

**Figure 3. Vce(sat) v.s. Vbe(sat)**

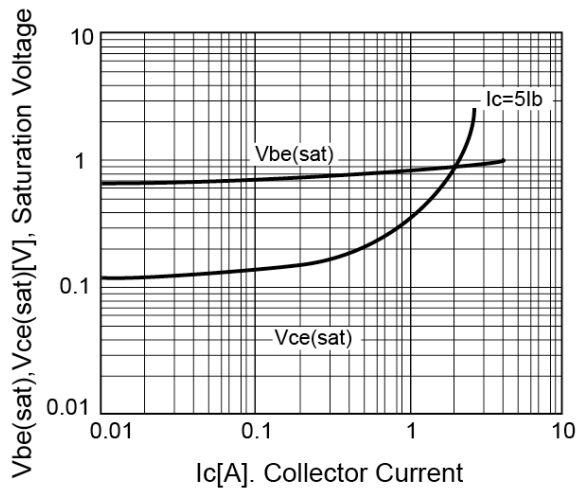

**Figure 4. Power Derating**

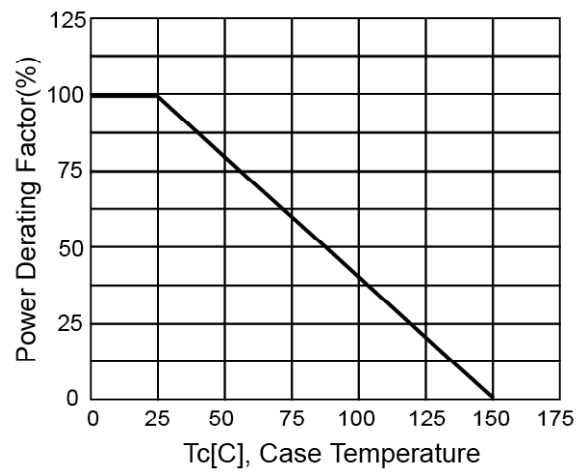

**Figure 5. Reverse Bias SOA**

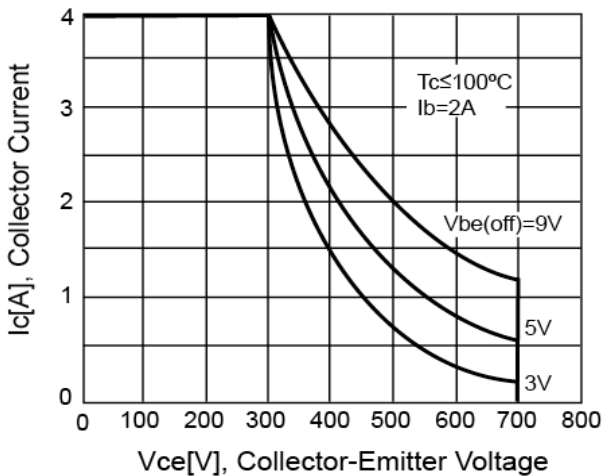

**Figure 6. Safety Operating Area**

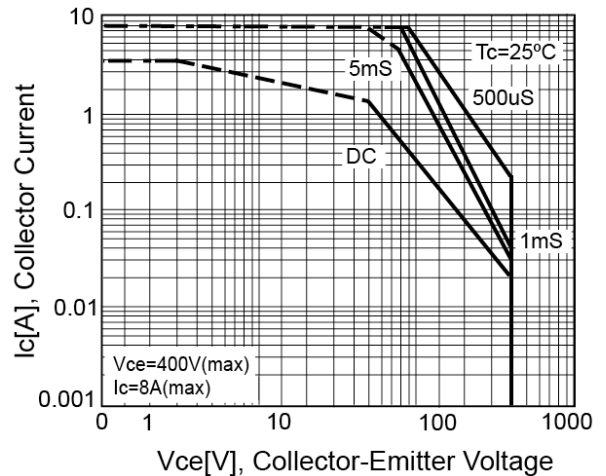

### TO-220 Mechanical Drawing

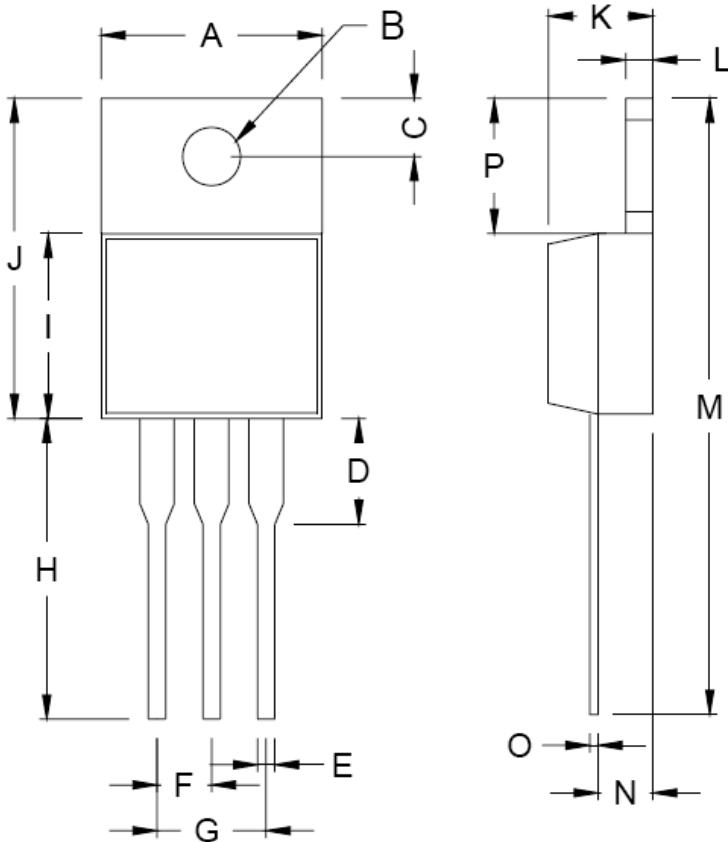

TO-220 DIMENSION				
DIM	MILLIMETERS		INCHES	
	MIN	MAX	MIN	MAX
A	9.31	10.550	0.366	0.415
B	3.740	3.910	0.147	0.154
C	2.440	2.940	0.096	0.116
D	2.22	3.22	0.087	0.127
E	0.78	0.98	0.030	0.038
F	2.34	2.65	0.092	0.104
G	4.69	5.31	0.184	0.209
H	12.32	13.88	0.485	0.546
I	8.74	9.26	0.344	0.364
J	15.07	16.07	0.593	0.632
K	4.35	4.65	0.171	0.183
L	1.16	1.40	0.045	0.055
M	27.39	30.35	1.078	1.194
N	1.785	2.675	0.070	0.105
O	1.50	1.75	0.059	0.068
P	5.75	7.65	0.226	0.301

### Marking Diagram

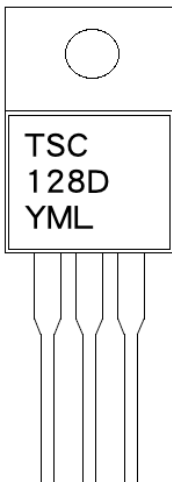

- Y** = Year Code
- M** = Month Code  
(A=Jan, B=Feb, C=Mar, D=Apr, E=May, F=Jun, G=Jul, H=Aug, I=Sep, J=Oct, K=Nov, L=Dec)
- L** = Lot Code

## Notice

Specifications of the products displayed herein are subject to change without notice. TSC or anyone on its behalf, assumes no responsibility or liability for any errors or inaccuracies.

Information contained herein is intended to provide a product description only. No license, express or implied, to any intellectual property rights is granted by this document. Except as provided in TSC's terms and conditions of sale for such products, TSC assumes no liability whatsoever, and disclaims any express or implied warranty, relating to sale and/or use of TSC products including liability or warranties relating to fitness for a particular purpose, merchantability, or infringement of any patent, copyright, or other intellectual property right.

The products shown herein are not designed for use in medical, life-saving, or life-sustaining applications. Customers using or selling these products for use in such applications do so at their own risk and agree to fully indemnify TSC for any damages resulting from such improper use or sale.