

***ALQ15 Dual Output Open-Frame DC-DC Converter Module***  
***Industry Standard ¼ Brick: 36V-75V Input / 60W Output Power***

The ALQ15 series is Astec's latest dual output; high-density converter offering that comes in an industry standard ¼ brick open-frame package. With its independently controlled output rails, the module effectively minimizes cross regulation, which has been an issue to most dual converters available in the market. The ALQ15 series has been designed to deliver 60W of clean, well-regulated, low noise DC power for today's demanding loads at respectable efficiency levels: 3.3V-2.5V combination @ 87.5% (60W output power). Output combinations currently available are 5.0V/3.3V - 3.3V/2.5V - 3.3V/1.8V - 2.5V/1.5V, with each output rail able to deliver 15A max (5V@12A). The module comes with standard feature sets such as output enable with positive or negative options; output voltage-adjust; over current, over voltage and over temperature protection. In addition, it is also being offered at both 5mm (std) and 3.7mm pin lengths.

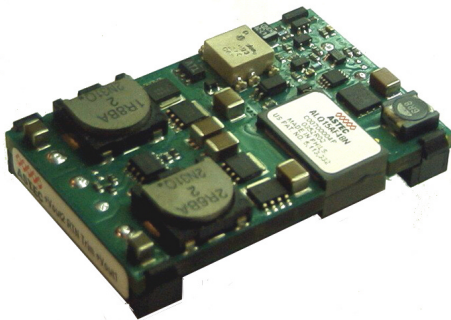

**Electrical Parameters**

**Input**

<b>Input Range</b>	<b>36-75 VDC</b>
<b>Input Surge</b>	<b>100V / 100ms</b>
<b>Efficiency</b>	<b>5.0V/3.3V @ 89.5% (Typ at 60W)</b>
	<b>3.3V/2.5V @ 87.7%</b>
	<b>3.3V/1.8V @ 86.5%</b>
	<b>2.5V/1.5V @ 84.0%</b>

**Control**

<b>Enable</b>	<b>TTL compatible</b>
<b>(Positive and Negative Enable Options)</b>	

**Output**

<b>Load Current</b>	<b>15A max per channel (60W max)</b>
	<b>5V @ 12A max</b>
<b>Line/Load Regulation</b>	<b>&lt; 1% V<sub>O</sub> (Typ)</b>
<b>Ripple and Noise</b>	<b>30mV<sub>PK-PK</sub></b>
<b>Output Voltage</b>	
<b>Adjust Range</b>	<b>±10% V<sub>O</sub></b>
<b>Transient Response</b>	<b>3% V<sub>O</sub> deviation max (3.3V)</b>
	<b>50% to 75% Load Change</b>
	<b>220 msec typical settling time</b>
	<b>(for 3.3V)</b>
<b>Over Current Protection</b>	<b>130% I<sub>O,max</sub> typical</b>

**Special Features**

- Tight Regulation
- Low Ripple and Noise at < 30mV<sub>PK-PK</sub>
- Industry Standard ¼ Brick Footprint
- Positive and Negative Enable Options
- Regulation to Zero Load
- High Capacitive Load Start-up
- Fixed Switching Frequency
- Output Trim
- Input Under-Voltage Lockout
- Basic Insulation

**Environmental Specifications**

- -40°C to 85°C Operating Temperature
- -55°C to 125°C Storage Temperature
- Designed for > 1 million hours MTBF

**Safety**

**UL + cUL 60950, Recognized**  
**EN60950 through TUV-PS**  
**CB Report**



**Technical Reference Notes**  
**ALQ15XX48X Series**  
**(Open Frame Dual Output Quarter Brick)**



**ALQ15 SERIES**

<b>MODEL NAME</b>	<b>CONSTRUCTION</b>	<b>V<sub>OUT</sub> / I<sub>OUT</sub></b>
ALQ15AF48	Open Frame	5.0V-12A / 3.3V-15A
ALQ15FG48	Open Frame	3.3V-15A / 2.5V-15A
ALQ15FG48N-6D*	Open Frame	3.3V-15A / 2.5V-15A
ALQ15FY48	Open Frame	3.3V-15A / 1.8V-15A
ALQ15GM48	Open Frame	2.5V-15A / 1.5V-15A

**OPTIONS:**

**SUFFIX**

Negative Enable: "N"  
Positive Enable: No suffix  
3.7mm (nominal) Pin Length: "-6"

\* Check Part Numbering Scheme on Table 2 and the corresponding external trim function on Table 1-D



**Technical Reference Notes**  
**ALQ15XX48X Series**  
**(Open Frame Dual Output Quarter Brick)**



**Electrical Specifications**

**STANDARD TEST CONDITION** on a single module unless otherwise specified.

TA:		25°C (Ambient Air)
+V <sub>IN</sub> :	PIN 1	48V ± 2V
ENABLE:	PIN 2	Open (Positive Enable)
-V <sub>IN</sub> :	PIN 3	Return Pin for +VIN
+V <sub>OUT2</sub> :	PIN 4	Connect to Load 2
-V <sub>OUT</sub> :	PIN 5	Return Pin for Load 1 & 2
TRIM:	PIN 6	Open
+V <sub>OUT1</sub> :	PIN 7	Connect to Load 1
Airflow		Refer to the appropriate derating curve

**ABSOLUTE MAXIMUM RATINGS**

Stresses in excess of the absolute maximum ratings can cause permanent damage to the converter. Functional operation of the device is converter is not implied at these or any other conditions in excess of those given in the operational section of the specs. Exposure to absolute maximum ratings for extended period can adversely affect device reliability.

Parameter	Device	Symbol	Min	Typ	Max	Unit
Input Voltage:						
Continuous	All	V <sub>IN</sub>	0	-	75	Vdc
Transient(100ms) :	All	V <sub>IN, trans</sub>	0	-	100	Vdc
Operating Ambient Temperature <sup>1</sup>	All	T <sub>A</sub>	-40	-	+85	°C
Storage Temperature	All	T <sub>STG</sub>	-55	-	125	°C
Operating Humidity	All	-	-	-	85	%
I/O Isolation	All	-	1500	-	-	Vdc
Maximum Enable Voltage	All				25	Vdc

NOTE: 1. Power Derating applies. Refer to Figures 15 to 18.



**Technical Reference Notes**  
**ALQ15XX48X Series**  
 (Open Frame Dual Output Quarter Brick)



**Electrical Specifications** *(continued)*

**INPUT SPECIFICATION**

Parameter	Device	Symbol	Min	Typ	Max	Unit
Operating Input Voltage	All	$V_{IN}$	36	48	75	$V_{DC}$
Maximum Input Current <sup>2</sup> Conditions: $V_{IN}$ = between 0 to $V_{IN,min}$ $P_O = P_{O,max}$ ; $T_A = 25\text{ }^\circ\text{C}$	AF FG FY GM	$I_{IN,max}$	-	-	2.20 2.20 2.20 2.27	A
Input Reflected Ripple Current <sup>3</sup> Conditions: $P_O = P_{O,max}$ ; $T_A = 25\text{ }^\circ\text{C}$	All	$I_{I1}/I_{I2}$	-	10	20	$\text{mA}_{PK-PK}$
Standing Loss Condition: $V_{IN} = V_{IN,nom}$ ; $T_A = 25\text{ }^\circ\text{C}$	All	-	-	-	3.0	W

- NOTE: 2. The power module is not internally fused. An input line fuse (e.g. Littelfuse Type 312003, 3A, 250V) is recommended.  
 3. See Figure 1 for Input Reflected Ripple Current Test Setup.

**OUTPUT SPECIFICATIONS**

Parameter	Device	Symbol	Min	Typ	Max	Unit
Voltage Setpoint Conditions: $V_I = V_{IN,nom}$ ; $T_A = 25\text{ }^\circ\text{C}$ ; $V_{O1}$ : $I_{O1} = I_{O,max}$ ; $P_O = 60\text{W}$ $V_{O2}$ : $I_{O2} = I_{O,max}$ ; $P_O = 60\text{W}$	AF FG FY GM	$V_{O1}/V_{O2}$ $V_{O1}/V_{O2}$ $V_{O1}/V_{O2}$ $V_{O1}/V_{O2}$	4.93 / 3.25 3.25 / 2.46 3.25 / 1.76 2.46 / 1.47	5.00 / 3.30 3.30 / 2.50 3.30 / 1.80 2.50 / 1.50	5.08 / 3.35 3.35 / 2.54 3.35 / 1.84 2.54 / 1.53	Vdc
Load Current	5.0V 3.3V 2.5V 1.8V 1.5V	$I_{O1}/I_{O2}$ $I_{O1}/I_{O2}$ $I_{O1}/I_{O2}$ $I_{O1}/I_{O2}$ $I_{O1}/I_{O2}$	0 0 0 0 0	- - - - -	12.0 15.0 15.0 15.0 15.0	A
Combined Output Power $P_O = P_{O1} + P_{O2}$	AF FG FY GM	$P_O$ $P_O$ $P_O$ $P_O$	- - - -	- - - -	60 60 60 60	W
Line Regulation: Conditions: $V_{IN} = V_{IN,min}$ to $V_{IN,max}$ ; $I_{O1} = I_{O,max}$ , $I_{O2} = I_{O,min}$ $V_{IN} = V_{IN,min}$ to $V_{IN,max}$ ; $I_{O1} = I_{O,min}$ , $I_{O2} = I_{O,max}$	5.0V 3.3V 2.5V 1.8V 1.5V	- - - - -	- - - - -	0.06 0.03 0.03 0.03 0.03	0.15 0.10 0.10 0.10 0.10	% $V_o$



**Technical Reference Notes**  
**ALQ15XX48X Series**  
**(Open Frame Dual Output Quarter Brick)**



**Electrical Specifications** *(continued)*

**OUTPUT SPECIFICATIONS**

Parameter	Device	Symbol	Min	Typ	Max	Unit
Load Regulation <sup>4</sup> Conditions: $I_O = 1A$ to $I_{O,max}$ ; $V_{IN} = V_{IN,nom}$	5.0V 3.3V 2.5V 1.8V 1.5V		- - - - -	0.06 0.12 0.20 0.26 0.33	0.40 0.60 0.70 0.90 1.00	%Vo
Cross Regulation <sup>4</sup> Conditions: $V_{IN} = V_{IN,nom}$ , $I_O = I_{O,max}$	All		-	-	0.20	%Vo
Temperature Conditions: $T_A = -40\text{ }^\circ\text{C}$ to $+65\text{ }^\circ\text{C}$ ; $V_{IN} = V_{IN,nom}$ , $I_O = I_{O,max}$	All		-	-	1.50	%Vo
Output Ripple and Noise: Peak-to-Peak <sup>5</sup> Conditions: $I_O = I_{O,max}$ , $V_{IN} = V_{IN,nom}$ ; BW = 20 MHz; $T_A = 25\text{ }^\circ\text{C}$	5.0 3.3 2.5 1.8 1.5		- - - - -	12 12 12 18 18	25 25 25 30 30	mV <sub>PK-PK</sub>
External Load Capacitance <sup>6</sup>	All		-	-	10000	$\mu\text{F}$
Over Current Limit Inception Conditions: $V_O = 90\% V_{O,nom}$ ; $I_{O2} = I_{O,min}$ , $V_{IN} = V_{IN,nom}$ Characteristics: Hiccup mode, auto-recovery	All 5.0V	$I_{O,OCF}$ $I_{O,OCF}$	16.5 13.2	- -	25 22	A
Output Short Circuit Conditions: $V_{IN} = V_{IN,nom}$ , $I_{O2} = 0A$ $T_A = 25\text{ }^\circ\text{C}$	All	$I_{OPK}$ $I_{ORMS}$ $I_{ODC}$ $I_{INS}$	-	-	28 5 1 150	$A_{PK}$ $A_{RMS}$ A mA
Efficiency Conditions: $V_{IN} = V_{IN,nom}$ , $T_A = 25\text{ }^\circ\text{C}$ $P_O = P_{O,max}$ , balanced current loading	AF FG FY GM	$\eta$ $\eta$ $\eta$ $\eta$	89.0 87.0 86.0 83.0	89.5 87.7 86.5 84.0	90.5 88.5 87.5 85.0	%
Switching Frequency Note: Can be determined from output ripple waveform	All	-	-	300	375	KHz

NOTE: 4. Channel under test shall follow the specified conditions while the other channel is set to min load, 0A.  
5. Channel under test shall be set to full load with the other channel set to  $I_{O,min}$  - See Fig 2 for the recommended output ripple and noise test setup.  
6. Refer to YSC plots on Fig 19 and 20 to determine loop stability at various output load impedance.



**Technical Reference Notes**  
**ALQ15XX48X Series**  
 (Open Frame Dual Output Quarter Brick)



**Electrical Specifications (continued)**

**OUTPUT SPECIFICATIONS**

Parameter	Device	Symbol	Min	Typ	Max	Unit
Dynamic Response <sup>7</sup> Conditions: $\Delta I_O/\Delta t = 0.15A/\mu s$ ; $V_{IN} = V_{IN,nom}$ ; $T_A = 25^\circ C$						
Peak Voltage Deviation	5.0V	-	-	0.8	2.0	%Vo
Load Change: $I_O = 50\%$ to $75\%$ or $75\%$ to $50\%$ $I_{O,max}$	3.3V	-	-	1.3	3.0	
	2.5V	-	-	1.6	3.0	
	1.8V	-	-	2.3	5.0	
	1.5V	-	-	2.8	5.0	
Transient Settling Time Note: $V_{O,nom}$ (ref.) (from ref. to $0.1\Delta V_{PK}$ )	5.0V	-	-	360	500	$\mu sec$
	3.3V	-	-	220	500	
	2.5V	-	-	210	500	
	1.8V	-	-	145	300	
	1.5V	-	-	136	300	
Turn-On Time Conditions: $V_{IN} = V_{IN,min}$ ; $I_{O1} = I_{O,max}$ , $I_{O2} = I_{O,min}$ ; $T_A = 25^\circ C$ Note: $V_{O1}$ within 1%	AF	-	-	21	30	msec
	FG	-	-	16	30	
	FY	-	-	16	30	
	GM	-	-	14	30	
Output Voltage Overshoot Conditions: $V_{IN} = V_{IN,nom}$ ; $T_A = 25^\circ C$ ; $P_O = 0W$	5.0V	-	-	0	1	%V <sub>O</sub>
	3.3V	-	-	0	1	
	2.5V	-	-	1	2	
	1.8V	-	-	2	4	
	1.5V	-	-	3	4	

NOTE: 7. Dynamic response tested with 10uF-aluminum and 1uF-tantalum capacitors across the load.

**FEATURE SPECIFICATION**

Parameter	Device	Symbol	Min	Typ	Max	Unit
Undervoltage Lockout	All	-	-	35.0	36.0	V
Turn-off Point	All	-	32	34.0	-	V
Output Voltage Adjustment Range	All	-	90	-	110	%V <sub>O</sub>
Conditions: $V_{IN} = V_{IN,nom}$ ; $T_A = 25^\circ C$						
$V_{O1}$ : $I_{O1} = I_{O,max}$ ; $I_{O2} = I_{O,min}$						
$V_{O2}$ : $I_{O1} = I_{O,min}$ ; $I_{O2} = I_{O,max}$						
Note: Tolerance = $\pm 1\%$						



**Technical Reference Notes**  
**ALQ15XX48X Series**  
 (Open Frame Dual Output Quarter Brick)



**Electrical Specifications** *(continued)*

**FEATURE SPECIFICATION**

Parameter	Device	Symbol	Min	Typ	Max	Unit
<u>Enable Pin Voltage</u>						
POSITIVE LOGIC						
Logic Low: Module OFF	w/o N-Suffix	$V_{ENABLE}$	0	-	2.2	V
Logic High: Module ON		$V_{ENABLE}$	1.5	-	5.0	V
NEGATIVE LOGIC						
Logic Low: Module ON	N-Suffix	$V_{ENABLE}$	0	-	2.2	V
Logic High: Module OFF		$V_{ENABLE}$	1.5	-	5.0	V
<u>Enable Pin Current</u>						
Logic Low	All	$I_{ENABLE}$	-	-	1.0	mA
Logic High: ( $I_{LKG}$ at $V_{ENABLE} = 5V$ )	All	$I_{ENABLE}$	-	-	50	$\mu A$
<u>Module Output Voltage</u>						
at Logic High (Negative Enable)	N-Suffix	$V_O$	-	-	1.2	V
at Logic Low (Positive Enable)	w/o N-Suffix	$V_O$	-	-	1.2	V
Output Over Voltage Clamp	5.0V	$V_{O,CLAMP}$	5.7	6.0	6.5	V
Conditions: $V_{IN} = V_{IN,nom}$ ; $T_A = 25^\circ C$	3.3V	$V_{O,CLAMP}$	3.8	3.9	4.3	V
Characteristics: Hiccup mode;	2.5V	$V_{O,CLAMP}$	2.8	3.0	3.4	V
auto-tracking wrt $V_{out}$	1.8V	$V_{O,CLAMP}$	2.0	2.2	2.4	V
trim	1.5V	$V_{O,CLAMP}$	1.7	1.8	2.1	V
Over-Temperature Shutdown	All	$T_B$	110	115	120	$^\circ C$
Note: 1. $T_{comp(max)} < 140^\circ C$						
2. Measured in the vicinity of pin 3 and R29						

**ISOLATION SPECIFICATION**

Parameter	Device	Symbol	Min	Typ	Max	Unit
Isolation Capacitance	All	-	-	680	-	pF
Isolation Resistance	All	-	10	-	-	M $\Omega$

### SAFETY APPROVAL

The ALQ15 series have been certified through:

- UL + cUL 60950, Third Edition - Recognized
- EN 60950 through TUV-PS
- CB Report
- Basic Insulation

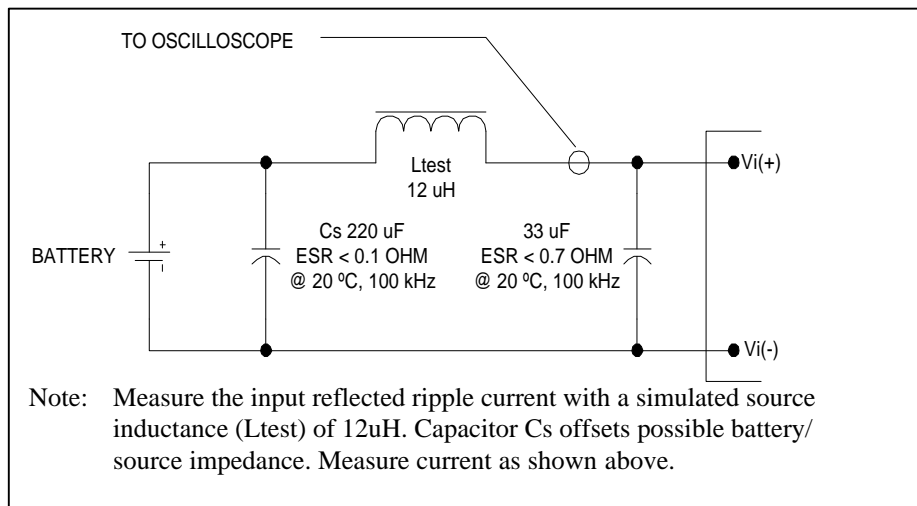

Figure 1. Input Reflected Ripple Current Measurement Setup.

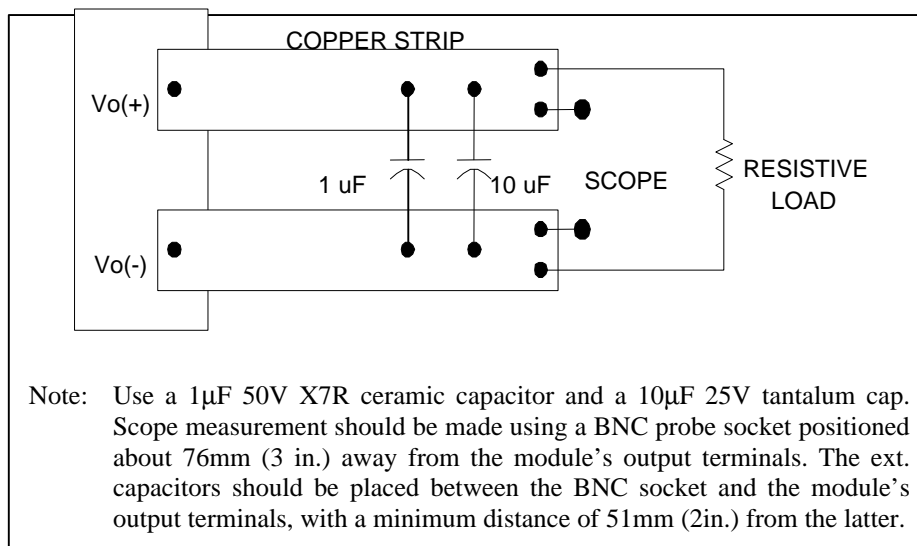

Figure 2. Peak to Peak Output Noise Measurement Setup.



## Basic Operation and Features

### INPUT UNDER VOLTAGE LOCKOUT

To prevent any instability to the converter that may affect and consequently damage the end system, the ALQ15 series have been designed to turn-on once  $V_{IN}$  is in the voltage range of 35-36 VDC. Likewise, it has also been programmed to turn-off when  $V_{IN}$  drops down to 32-34 VDC.

### OUTPUT VOLTAGE ADJUST/TRIM

The converter comes with a TRIM pin (PIN 6), which is used to adjust both outputs simultaneously by as much as 90% to 110% of its set point. This is achieved by connecting an external resistor as described below.

To INCREASE the output voltages, external  $R_{TRIM-UP}$  resistor should be connected between TRIM PIN (Pin6) and RTN PIN (Pin 5). Please refer to Figure 3 for the resistor configuration and Table 1 for the required resistor values in attaining the desired output adjustment

To DECREASE the output voltages, external  $R_{TRIM-DOWN}$  resistor should be connected between TRIM PIN (Pin 6) and  $V_{OUT1}$  (Pin 7). This trim configuration is true for the AF, FG, FY and GM standard versions. Please refer to Figure 4 for the resistor configuration and Table 1 for the required resistor values in attaining the desired output adjustment. For ALQ15FG48N-6D,  $R_{TRIM-DN}$  resistor is connected between the TRIM PIN and  $V_{OUT2}$  (2.5V output pin).

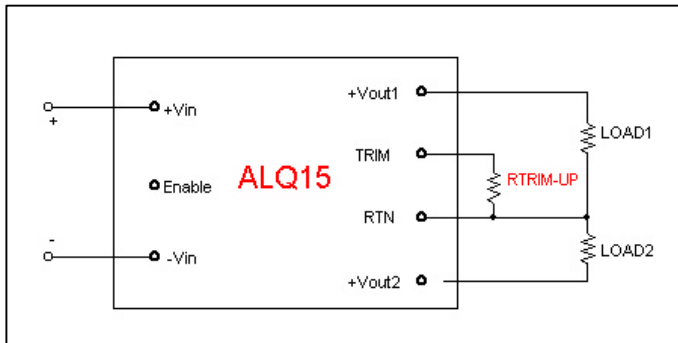

Figure 3. External Trim resistor setup to increase output for all versions.

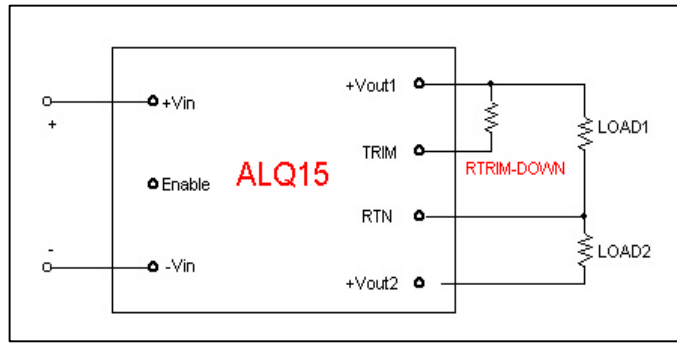

Figure 4. External Trim resistor setup to decrease output for AF; FG; FY and GM standard versions only.

**TABLE 1-A**

ALQ15AF48 (5V / 3.3V)			
? [%]	$R_{TRIM-UP}$ [kO]	? [%]	$R_{TRIM-DOWN}$ [kO]
+1	32.45	-1	32.39
+2	13.66	-2	15.09
+3	7.83	-3	8.95
+4	4.99	-4	5.80
+5	3.31	-5	3.89
+6	2.20	-6	2.60
+7	1.41	-7	1.67
+8	0.82	-8	0.98
+9	0.36	-9	0.44
+10	0.00	-10	0.00

**TABLE 1-B**

ALQ15FG48 / ALQ15FY48			
? [%]	$R_{TRIM-UP}$ [kO]	? [%]	$R_{TRIM-DOWN}$ [kO]
+1	12.42	-1	12.58
+2	5.26	-2	5.86
+3	3.02	-3	3.47
+4	1.93	-4	2.25
+5	1.28	-5	1.51
+6	0.85	-6	1.01
+7	0.55	-7	0.65
+8	0.32	-8	0.38
+9	0.14	-9	0.17
+10	0.00	-10	0.00



**Technical Reference Notes**  
**ALQ15XX48X Series**  
**(Open Frame Dual Output Quarter Brick)**



**Basic Operation and Features (continued)**

**TABLE 1-C**

<b>ALQ15GM48 (2.5V / 1.5V)</b>			
<b>? [%]</b>	<b>R<sub>TRIM-UP</sub> [kΩ]</b>	<b>? [%]</b>	<b>R<sub>TRIM-DOWN</sub> [kΩ]</b>
+1	70.46	-1	70.31
+2	29.65	-2	32.75
+3	17.00	-3	19.42
+4	10.83	-4	12.58
+5	7.18	-5	8.43
+6	4.77	-6	5.64
+7	3.06	-7	3.63
+8	1.78	-8	2.12
+9	0.79	-9	0.94
+10	0.00	-10	0.00

**TABLE 1-D**

<b>ALQ15FG48N-6D*</b>			
<b>? [%]</b>	<b>R<sub>TRIM-UP</sub> [kΩ]</b>	<b>? [%]</b>	<b>R<sub>TRIM-DOWN</sub> [kΩ]</b>
+1	46.84	-1	66.47
+2	20.82	-2	27.32
+3	12.14	-3	15.55
+4	7.81	-4	9.87
+5	5.20	-5	6.53
+6	3.47	-6	4.34
+7	2.23	-7	2.78
+8	1.30	-8	1.62
+9	0.58	-9	0.72
+10	0.00	-10	0.00

\* DI/DT's QD48T025033 Trim Equivalent

ALQ15 standard trim utilizes approximately similar range of trim resistors for both RTRIM-UP and RTRIM-DOWN to adjust the outputs. This facilitates ease of resistor selection and contributes to a decreased number of parts for customer inventory if the TRIM pin is being utilized.

**OUTPUT ENABLE**

The ALQ15 comes with an Enable pin (PIN 2), which is primarily used to turn ON/OFF the converter. Both a Positive (no part number suffix required) and a Negative (suffix "N" required) Enable Logic options are being offered. Please refer to Table 2 for the Part Numbering Scheme.

For Positive Enable, the converter is turned on when the Enable pin is at logic HIGH or left open. The unit turns off when the Enable pin is at logic LOW or directly connected to  $-V_{IN}$ . On the other hand, the Negative Enable version turns on when the Enable pin is at logic LOW or directly connected to  $-V_{IN}$ . The unit turns off when the Enable pin is at Logic HIGH.

**OUTPUT OVER VOLTAGE PROTECTION (OVP)**

The Over Voltage Protection circuit will shut down the entire converter if any of the two output voltages exceeds the OVP threshold limits. The converter will automatically recover once the fault is removed.

**OVER CURRENT PROTECTION (OCP)**

The Over Current Protection circuit will shutdown the converter if any of the load current of either output reaches the OCP threshold limits. The unit will automatically recover once the over current condition is removed. See Figure 12 for typical output characteristic under an over current condition.

**OVER TEMPERATURE PROTECTION (OTP)**

The Over Temperature Protection circuit will shutdown the converter once the sensed location reaches the OTP range. This feature prevents the unit from overheating and consequently going into thermal runaway, which may further damage the converter and the end system. Such overheating may be an effect of operation outside the given power thermal derating conditions. Restart is possible once the temperature of the sensed location drops to less than 110°C.

## Performance Curves

### ALQ15FG48

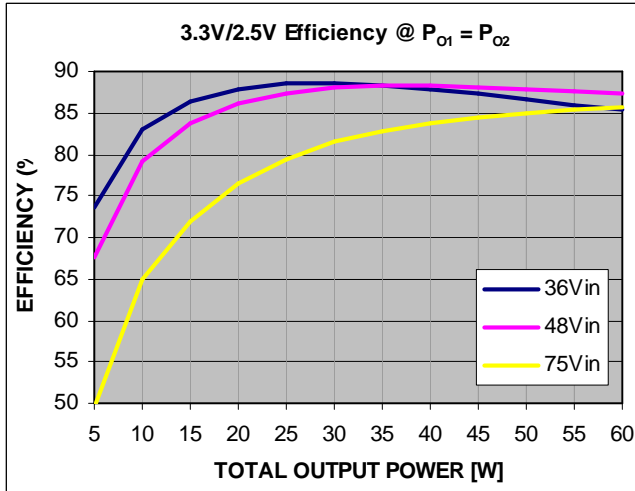

Figure 5. Efficiency at balanced power ( $P_{O1} = P_{O2}$ ) for various input voltages; taken at  $T_A=25^\circ\text{C}$  with the converter mounted vertically and with 200LFM airflow directed from Pin 3 to Pin 1.

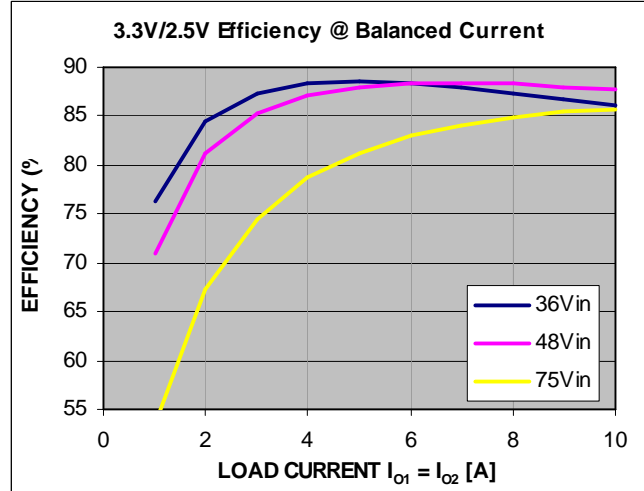

Figure 6. Efficiency curve for balanced output current ( $I_{O1} = I_{O2}$ ) at various input voltages; taken at  $T_A=25^\circ\text{C}$  with the converter mounted vertically and with 200LFM airflow directed from Pin 3 to Pin 1.

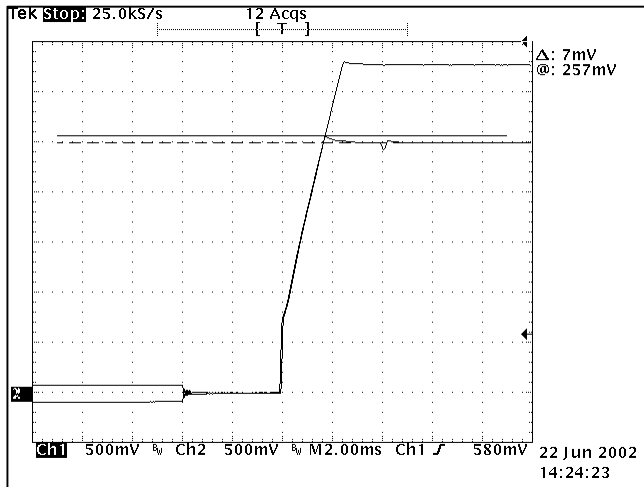

Figure 7. Start-up characteristic of  $V_{O1}$  (CH1) and  $V_{O2}$  (CH2) at balanced load current;  $V_{IN} = 48\text{V}$ .

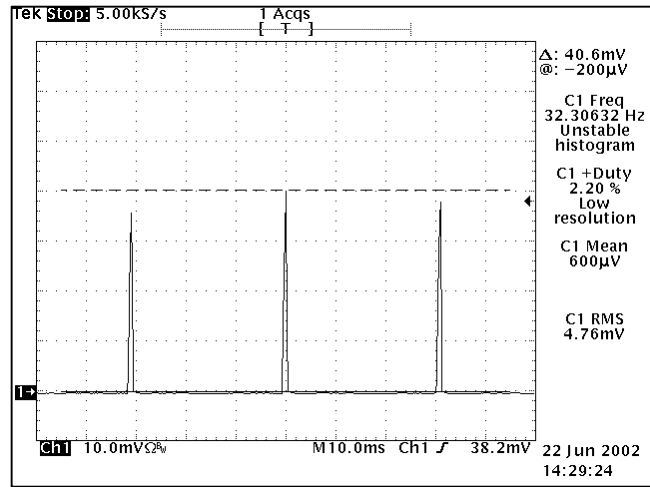

Figure 8. Typical output current waveform under an Over Current Condition. Output current scale at  $0.5\text{A}/\text{mV}$ .

**Performance Curves (continued)**

**ALQ15AF48 (5.0V / 3.3V) SERIES**

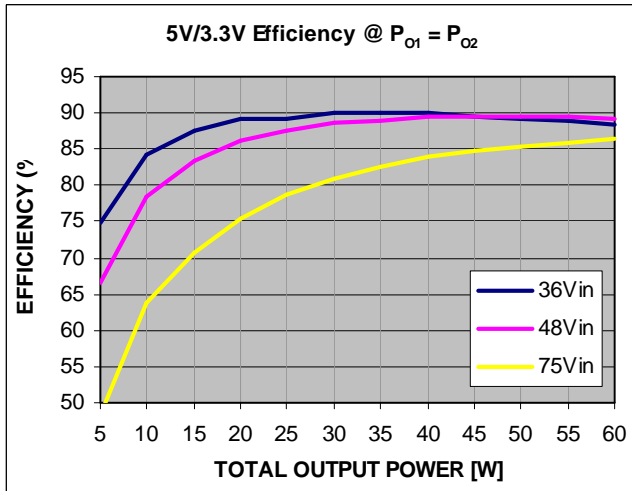

Figure 9. Efficiency at balanced power ( $P_{O1} = P_{O2}$ ) for various input voltages; taken at  $T_A=25^\circ\text{C}$  with the converter mounted vertically and with 100LFM airflow directed from Pin 3 to Pin 1.

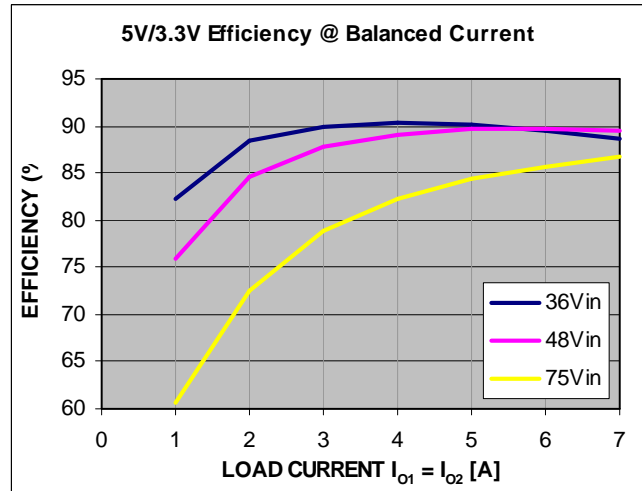

Figure 10. Efficiency curve for balanced output current ( $I_{O1} = I_{O2}$ ) at various input voltages; taken at  $T_A=25^\circ\text{C}$  with the converter mounted vertically and with 100LFM airflow directed from Pin 3 to Pin 1.

**ALQ15FY48 (3.3V / 1.8V) SERIES**

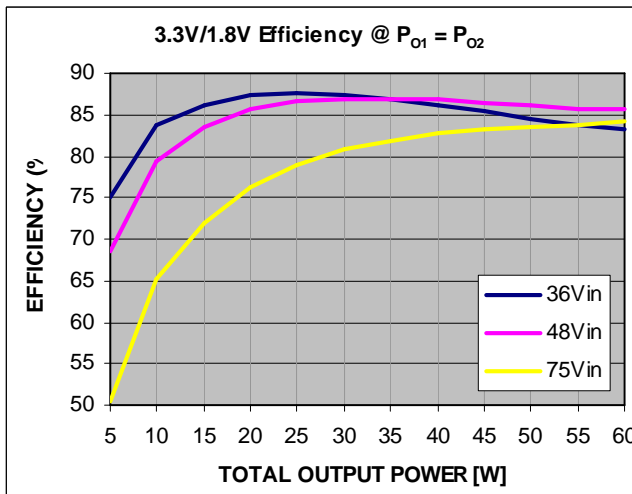

Figure 11. Efficiency at balanced power ( $P_{O1} = P_{O2}$ ) for various input voltages; taken at  $T_A=25^\circ\text{C}$  with the converter mounted vertically and with 300LFM airflow directed from Pin 3 to Pin 1.

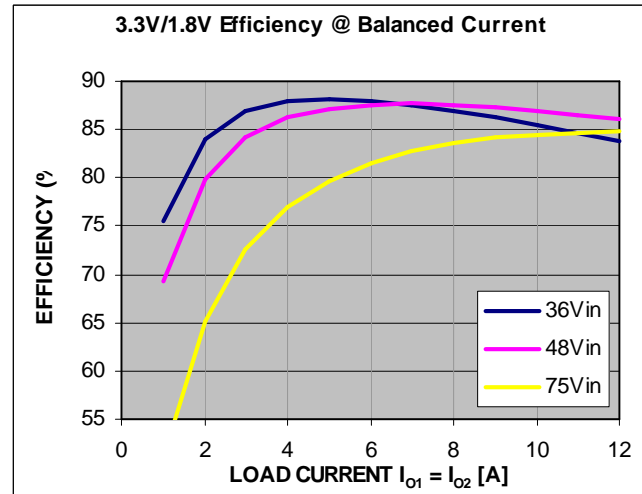

Figure 12. Efficiency curve for balanced output current ( $I_{O1} = I_{O2}$ ) at various input voltages; taken at  $T_A=25^\circ\text{C}$  with the converter mounted vertically and with 300LFM airflow directed from Pin 3 to Pin 1.



Technical Reference Notes  
ALQ15XX48X Series  
(Open Frame Dual Output Quarter Brick)



Performance Curves (continued)

ALQ15GM48 (2.5V / 1.5V) SERIES

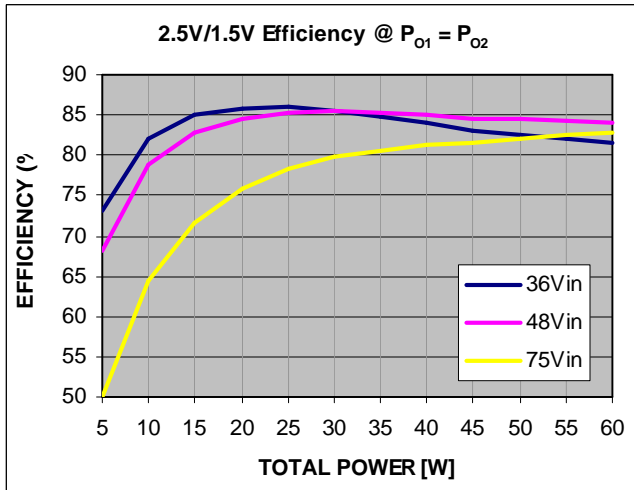

Figure 13. Efficiency at balanced power ( $P_{O1} = P_{O2}$ ) for various input voltages; taken at  $T_A=25^\circ\text{C}$  with the converter mounted vertically and with 400LFM airflow directed from Pin 3 to Pin 1.

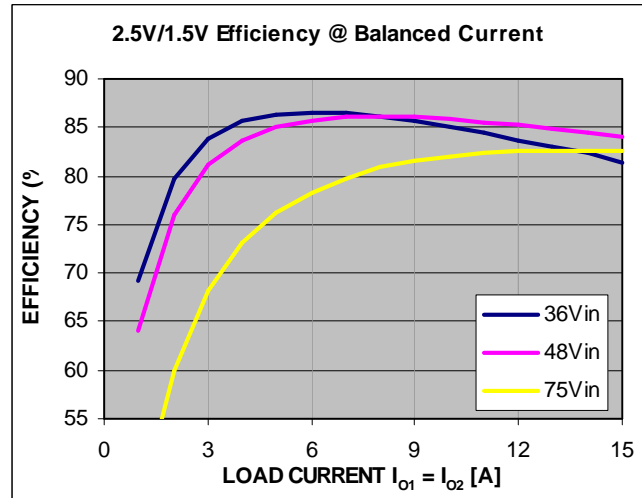

Figure 14. Efficiency curve for balanced output current ( $I_{O1} = I_{O2}$ ) at various input voltages; taken at  $T_A=25^\circ\text{C}$  with the converter mounted vertically and with 400LFM airflow directed from Pin 3 to Pin 1.



Technical Reference Notes  
ALQ15XX48X Series  
(Open Frame Dual Output Quarter Brick)



Performance Curves (continued)

CURRENT VS. TEMPERATURE CURVES

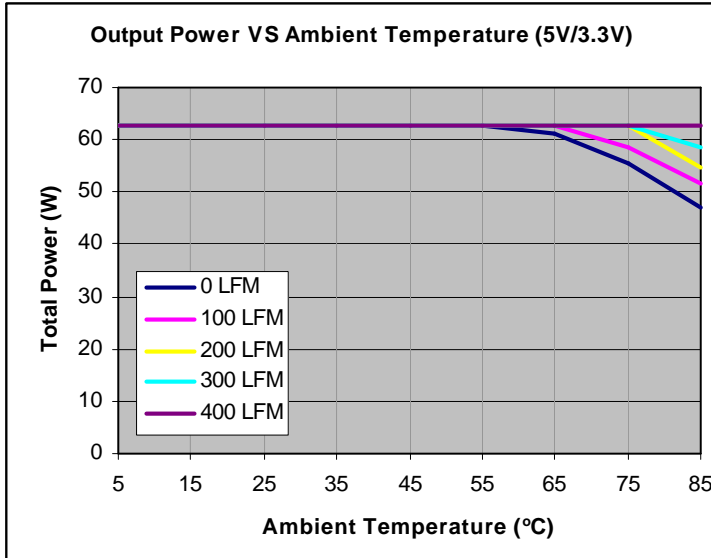

Figure 15. Total Output Power (balanced load:  $I_{O1} = I_{O2}$ ) vs. Ambient Temperature Curves for ALQ15AF48 version taken at various airflow conditions (converter mounted horizontally with airflow direction from PIN 3 to PIN1;  $V_{IN} = 48V$  nominal).

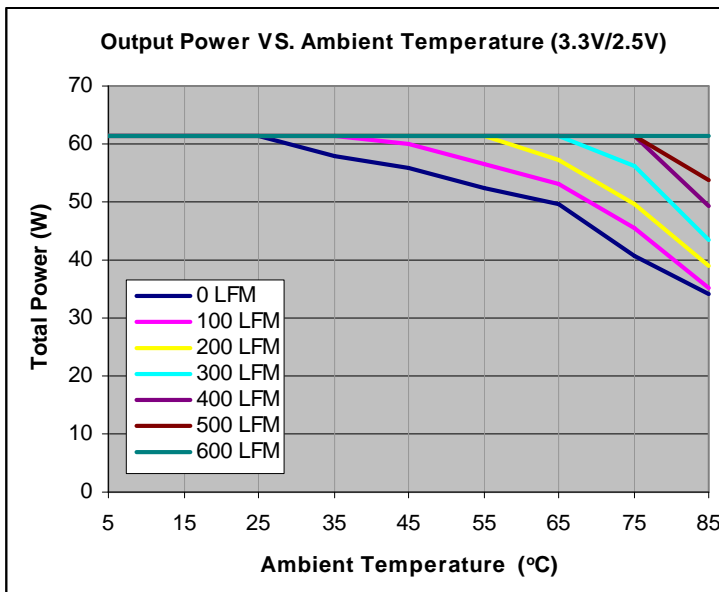

Figure 16. Total Output Power (balanced load:  $I_{O1} = I_{O2}$ ) vs. Ambient Temperature Curves for ALQ15FG48 version taken at various airflow conditions (converter mounted horizontally with airflow direction from PIN 3 to PIN1;  $V_{IN} = 48V$  nominal).



Technical Reference Notes  
ALQ15XX48X Series  
(Open Frame Dual Output Quarter Brick)



Performance Curves (continued)

CURRENT VS. TEMPERATURE CURVES

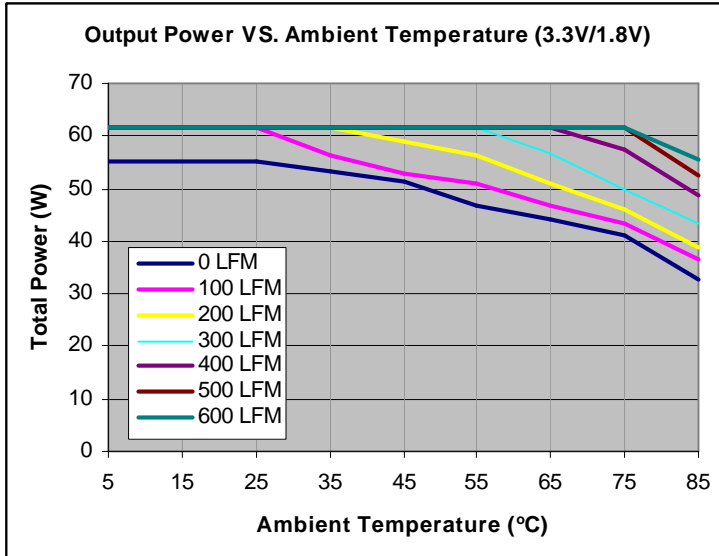

Figure 17. Total Output Power (balanced load:  $I_{O1} = I_{O2}$ ) vs. Ambient Temperature Curves for ALQ15FY48 version taken at various airflow conditions (converter mounted horizontally with airflow direction from PIN 3 to PIN1;  $V_{IN} = 48V$  nominal).

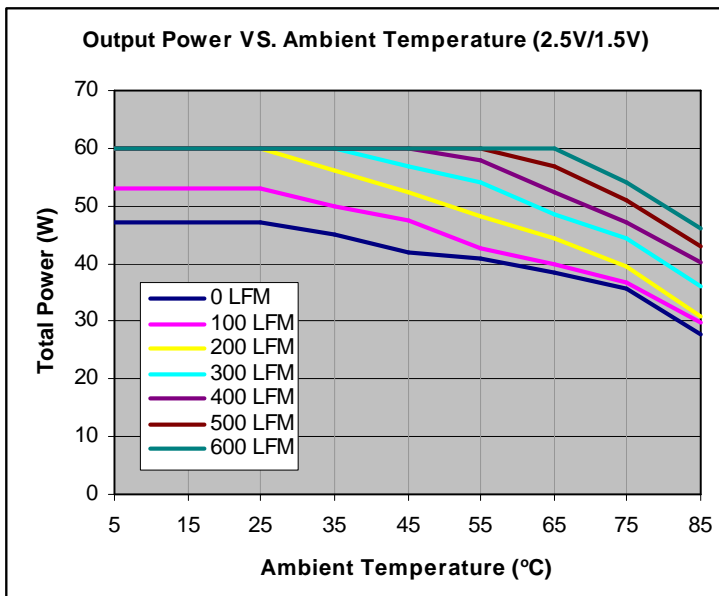

Figure 18. Total Output Power (balanced load:  $I_{O1} = I_{O2}$ ) vs. Ambient Temperature Curves for ALQ15GM48 version taken at various airflow conditions (converter mounted horizontally with airflow direction from PIN 3 to PIN1;  $V_{IN} = 48V$  nominal).

**Young's Stability Curves**

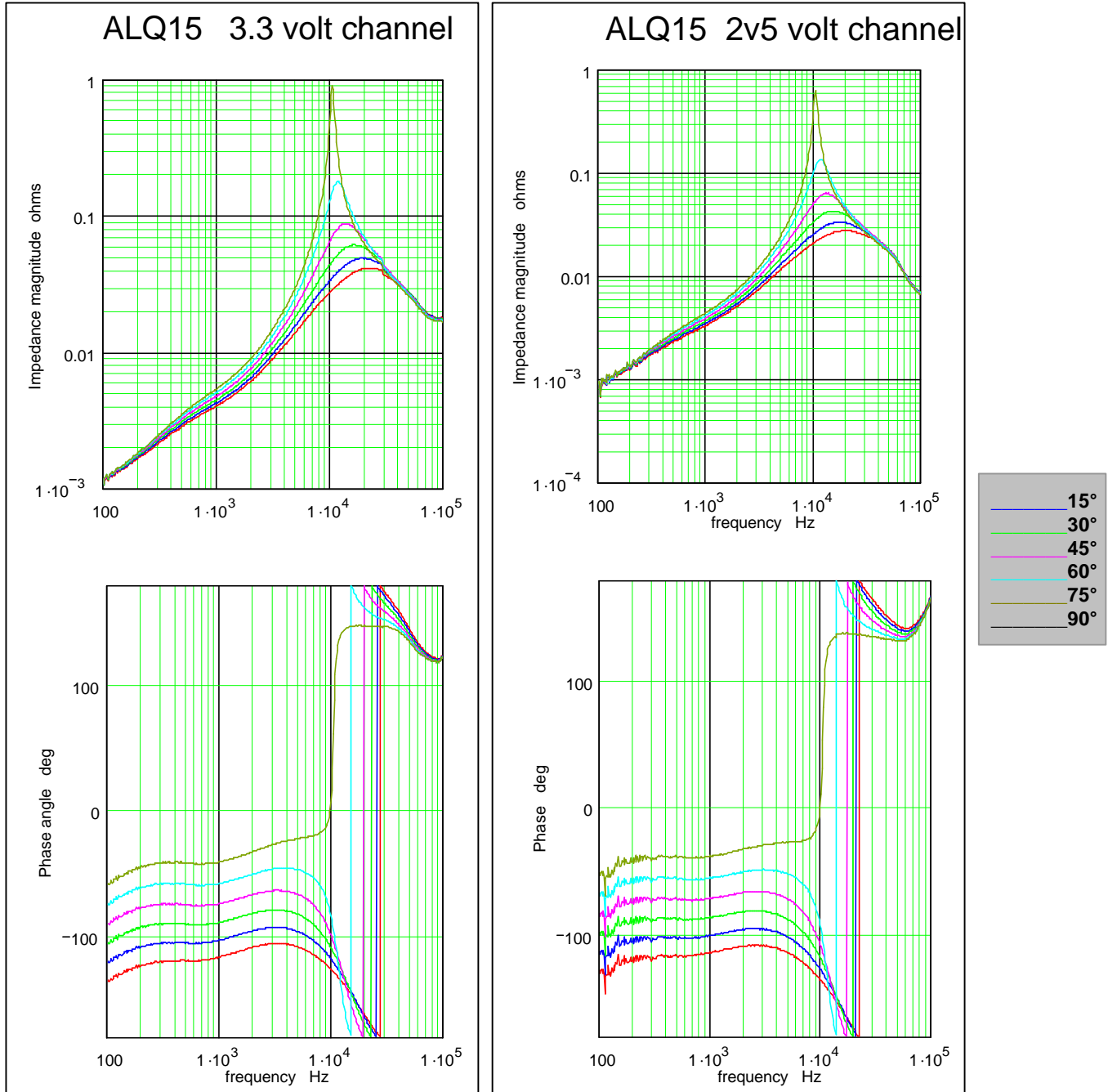

Figure 19. YSC Plots of 3V3 and 2V5 Output Channels.



**Young's Stability Curves (continued)**

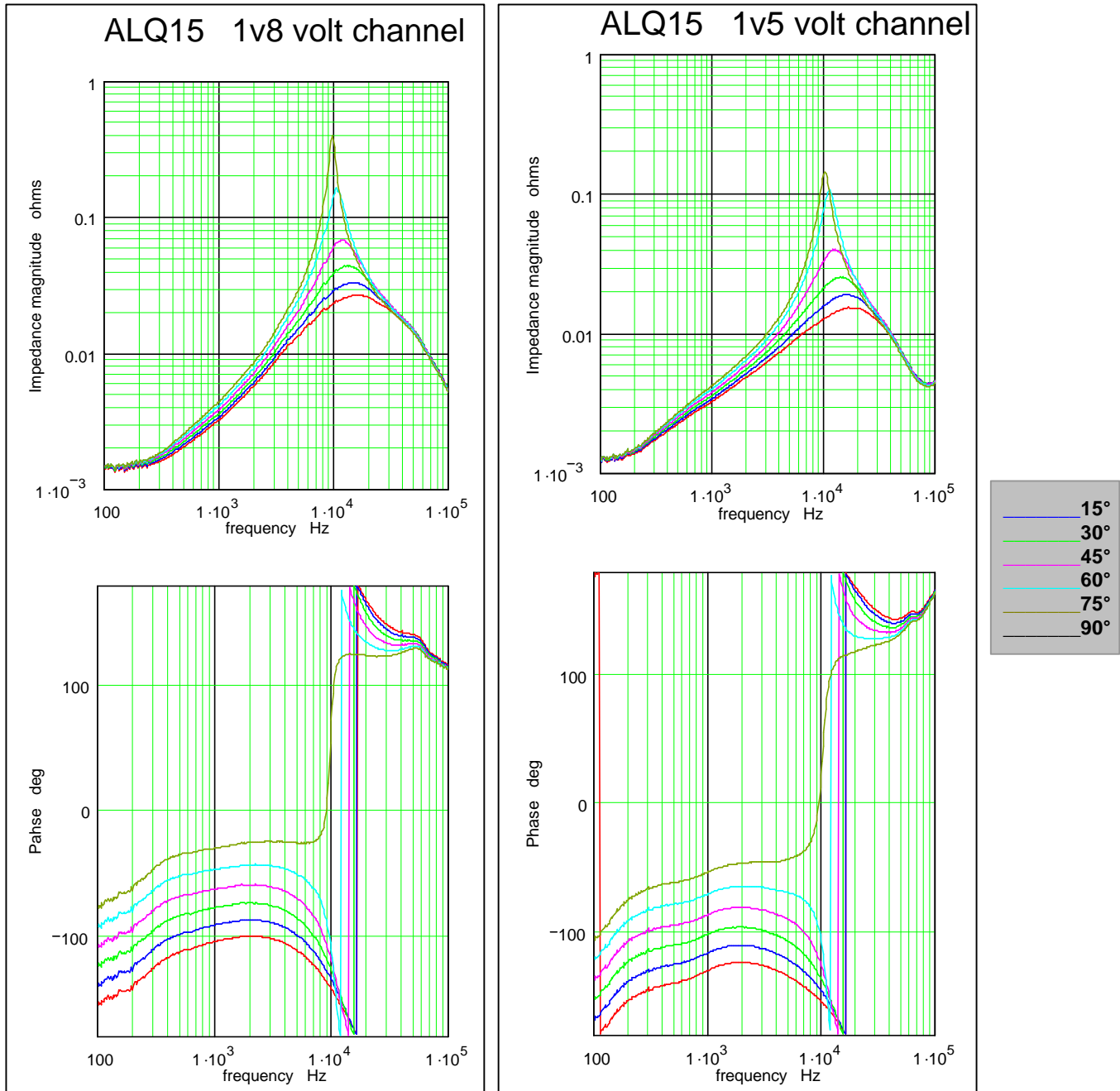

Figure 20. YSC Plots of 1V8 and 1V5 Output Channels.

### Mechanical Specifications

Parameter	Device	Symbol	Min	Typ	Max	Unit
Dimension	All	L	-	2.30 [58.4]	-	in [ mm ]
		W	-	1.48 [37.6]	-	in [ mm ]
		H	-	0.50 [12.6]	-	in [ mm ]
Weight			-		TBD	g [oz]
<b>PIN ASSIGNMENT</b>						
	<b>1</b>	<b>+V<sub>IN</sub></b>		<b>5</b>	<b>Secondary Return/ Ground TRIM +V<sub>O1</sub></b>	
	<b>2</b>	<b>ENABLE</b>		<b>6</b>		
	<b>3</b>	<b>-V<sub>IN</sub></b>		<b>7</b>		
	<b>4</b>	<b>+V<sub>O2</sub></b>				

NOTE: Pin diameters at  $\varnothing = 0.04$ " [1.02 mm] nominal.  
 Pin placement tolerance  $\pm 0.005$  [0.127]  
 Mechanical tolerance  $\pm 0.02$  [0.5]

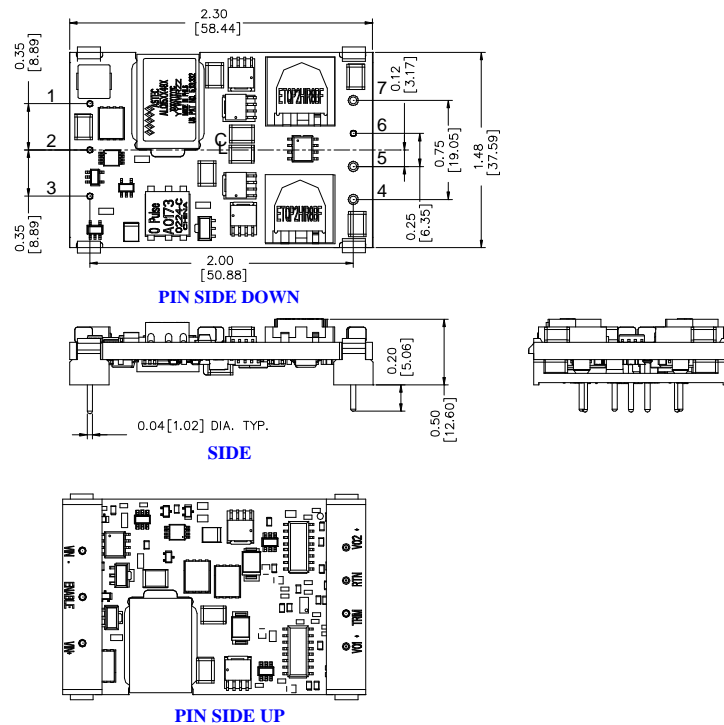

Figure 21. ALQ15 series mechanical outline ( inches [(mm)] ).



**Technical Reference Notes**  
**ALQ15XX48X Series**  
**(Open Frame Dual Output Quarter Brick)**



**Mechanical Specifications** *(continued)*

**SOLDERING CONSIDERATIONS**

The ALQ15 series converters are compatible with standard wave soldering techniques. When wave soldering, the converter pins should be preheated for 20-30 seconds at 110°C and wave soldered at 260°C for less than 10 seconds.

When hand soldering, the iron temperature should be maintained at 425°C and applied to the converter pins for less than 5 seconds. Longer exposure can cause internal damage to the converter. Cleaning can be performed with cleaning solvent IPA or with water.

**PART NUMBERING SCHEME FOR ORDERING**

	<b>OUTPUT VOLTAGE 1</b>	<b>OUTPUT VOLTAGE 2</b>		<b>ENABLE LOGIC</b>		<b>PIN LENGTH OPTION</b>	<b>SPECIAL FEATURE</b>
<b>ALQ15</b>	<b>v</b>	<b>w</b>	<b>48</b>	<b>x</b>	-	<b>y</b>	<b>z</b>
	A = 5.0V F = 3.3V F = 3.3V G = 2.5V	F = 3.3V G = 2.5V Y = 1.8V M = 1.5V		"Blank" = Positive "N" = Negative		"Blank" = 5mm (Std) "-6" = 3.7mm	"D" – Special Trim function

TABLE 2. Part Numbering information.

Please call 1-888-41-ASTEC for further inquiries or visit us at [www.astecpower.com](http://www.astecpower.com)