

● Features:

1. Emitted Color : Yellow Green
2. Lens Appearance : Water Clear.
3. Mono-color type.
4. 1.6x0.8x0.8mm(0603) standard package.
5. Suitable for all SMT assembly methods.
6. Compatible with infrared and vapor phase reflow solder process.
7. Compatible with automatic placement equipment.
8. This product doesn't contain restriction Substance, comply ROHS standard.

● Applications:

1. Automotive : Dashboards, stop lamps, turn signals.
2. Backlighting : LCDs, Key pads advertising.
3. Status indicators : Consumer & industrial electronics.
4. General use.

● Package Dimensions:

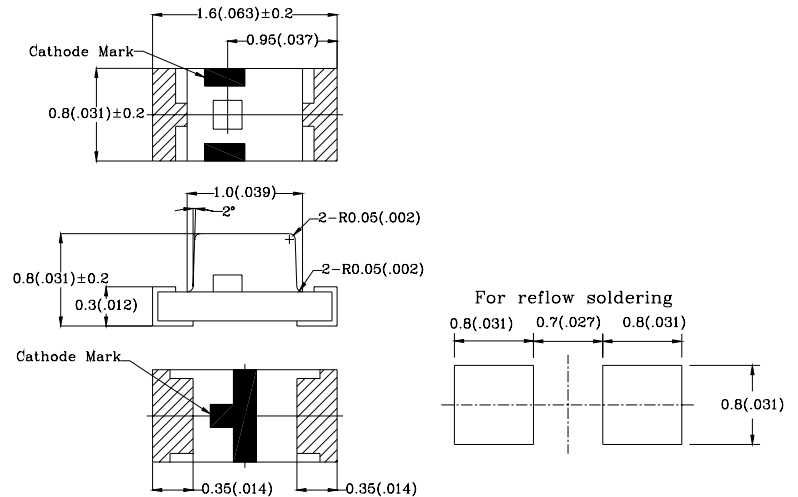

NOTES:

1. All dimensions are in millimeters (inches).
2. Tolerance is ±0.10mm (0.004") unless otherwise specified.
3. Specifications are subject to change without notice.

● Absolute Maximum Ratings(Ta=25°C)

Parameter	Symbol	Rating	Unit
Power Dissipation	Pd	80	mW
Forward Current	I _F	30	mA
Peak Forward Current * 1	I _{FP}	100	mA
Reverse Volage	V _R	5	V
Operating Temperature	Topr	-55°C~85°C	-
Storage Temperature	Tstg	-55°C~85°C	-
Soldering Temperature	Tsol	See Page6	-
Derating Linear From 25°C	-	0.6	mA/°C
Infrared Soldering Condition	-	240°C (for 10 Seconds)	-
Vapor Soldering Condition	-	215°C (for 3Minutes)	-

* 1 Condition for I_{FP} is pulse of 1/10 duty and 0.1msec width.

● Electrical and optical characteristics(Ta=25°C)

Parameter	Symbol	Condition	Min.	Typ.	Max.	Unit
Forward Voltage	V _f	I _F =20mA	-	2.0	2.6	V
Luminous Intensity	I _v	I _F =20mA	3.7	10.0	-	mcd
Reverse Current	I _R	V _R =5V	-	-	100	μA
Peak Wave Length	λ _p	I _F =20mA	-	568	-	nm
Dominant Wave Length	λ _d	I _F =20mA	566	-	576	nm
Spectral Line Half-width	Δλ	I _F =20mA	-	30	-	nm
Veiwng Angle	2θ _{1/2}	I _F =20mA	-	120	-	deg

● Typical Electro-Optical Characteristics Curves

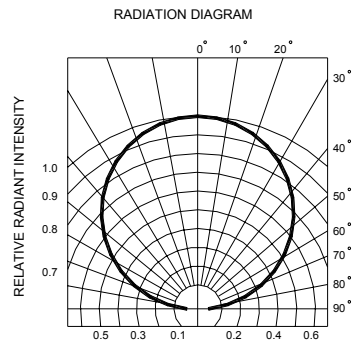
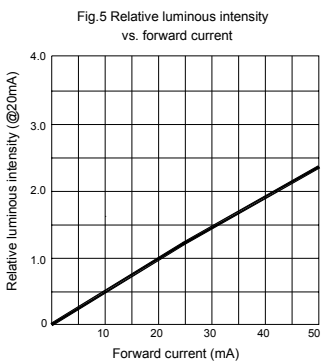
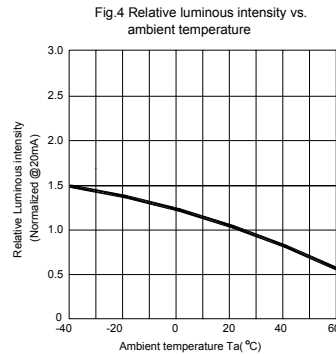
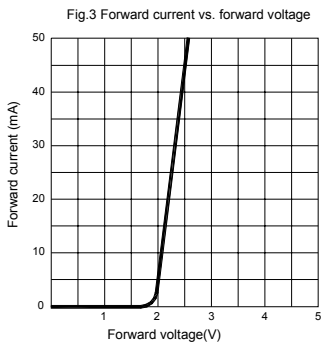
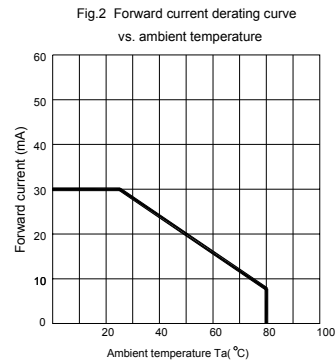
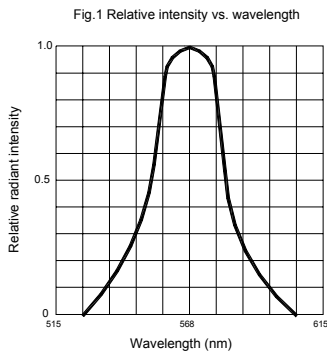

● Tapping and packaging specifications(Units: mm)

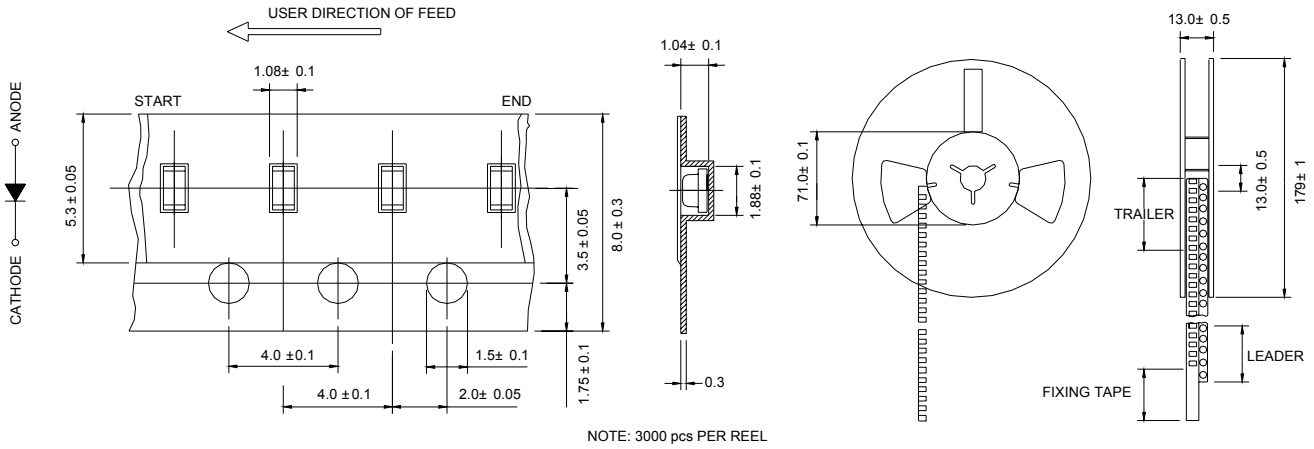

● Package Method:(unit:mm)

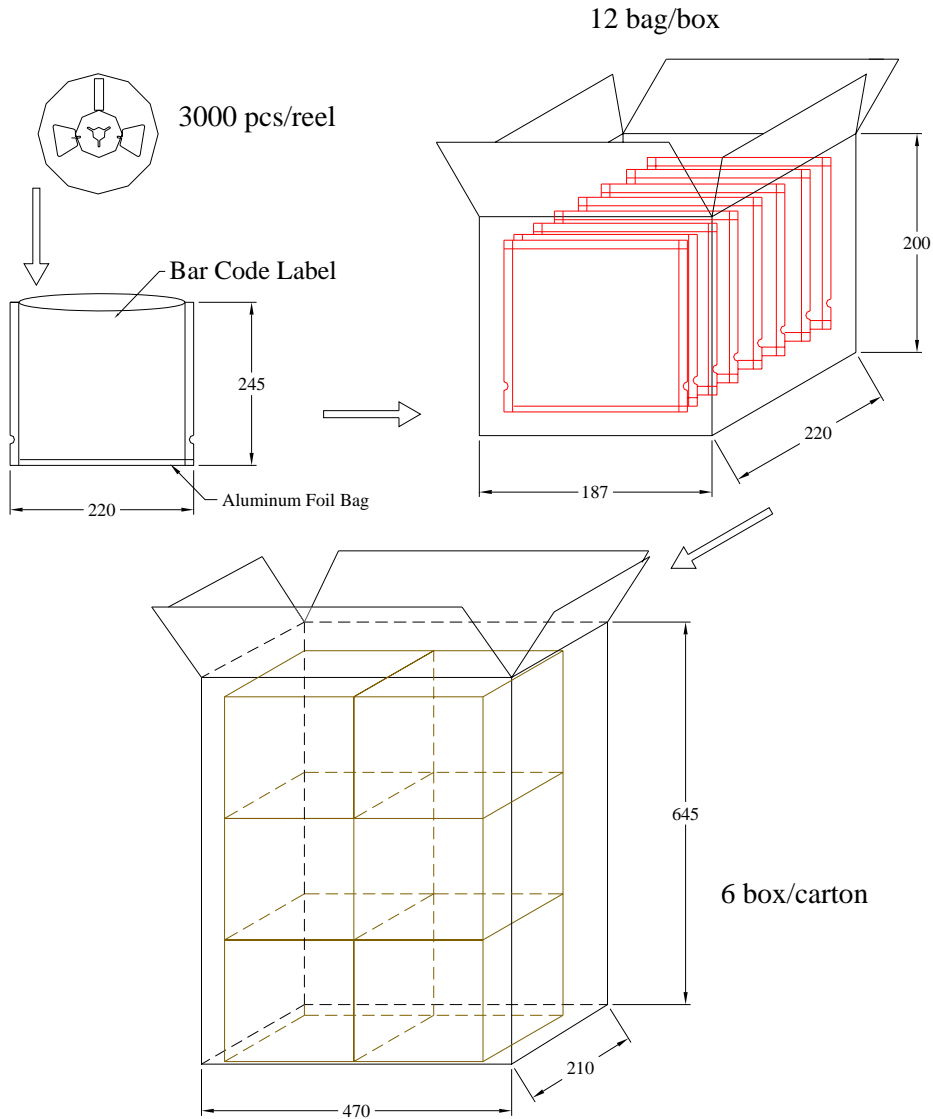

● **Bin Limits**

Intensity Bin Limits (At 20mA)

BIN CODE	Min. (mcd)	Max. (mcd)
G	3.2	6.3
H	4.8	9.4
J	7.0	14.0
K	11.0	21.0

Color Bin Limits (At 20mA)

BIN CODE	Min. (mcd)	Max. (mcd)
4	565	569
5	567	571
6	569	573
7	571	575
8	573	577

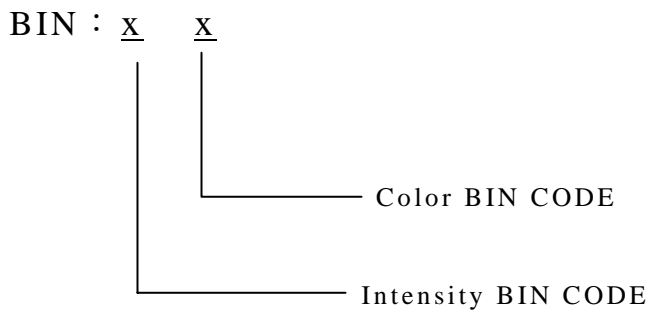

● Reliability Test

Classification	Test Item	Reference Standard	Test Conditions	Result	
Endurance Test	Operation Life	MIL-STD-750:1026 MIL-STD-883:1005 JIS-C-7021 :B-1	Ta=Under Room Temperature As Per Data Sheet Maximum Rating Test Time=1000HRS(-24HRS,+72HRS)@20mA	0/20	
	High Temperature High Humidity Storage	MIL-STD-202:103B JIS-C-7021 :B-11	Ta=+65°C±5°C RH=90%-95% Test time=240hrs±2HRS	0/20	
	High Temperature Storage	MIL-STD-883:1008 JIS-C-7021 :B-10	High Ta=+105°C±5°C Test time=1,000hrs(-24HRS,+72HRS)	0/20	
	Low Temperature Storage	JIS-C-7021 :B-12	Low Ta=-55°C±5°C Test time=1,000hrs(-24HRS,+72HRS)	0/20	
Environmental Test	Temperature Cycling	MIL-STD-202:107D MIL-STD-750:1051 MIL-STD-883:1010 JIS-C-7021 :A-4	+105°C ~ +25°C ~ -55°C ~ +25°C 30min 5min 30min 5min Test Time=10cycle	0/20	
	Thermal Shock	MIL-STD-202:107D MIL-STD-750:1051 MIL-STD-883:1011	IR-Reflow In-Board, 2 Times 85±5 °C (10min)~-40±5°C (10min) Test Time=10cycle	0/20	
	Solder Resistance	MIL-STD-202:201A MIL-STD-750:2031 JIS-C-7021 :A-1	T.sol=260±5°C Dwell Time=10±1secs	0/20	
	IR-Reflow	-	Ramp-up rate(183°C to Peak)+3°C 1sec max	0/20	
	Solderability	-	-	Temp maintain at 125±25°C 120sec max	0/20
				Temp maintain above 183°C 60~150sec	0/20
				Peak temperature range 235°C ~ 240°C	0/20
				Time within 5°C of actual Pwck Temperature 10-30sec	0/20
				Ramp-down rate +6°C 1sec max	0/20
	Solderability	-	-	T.sol=235±5°C	0/20
Immersion time 2±0.5sec				0/20	
Immersion rate 25±2.5mm/sec				0/20	
Coverage ≥ 95% of the dipped surface				0/20	

● Judgment criteria of failure for the reliability

Measuring items	Symbol	Measuring conditions	Judgement criteria for failure
Forward voltage	V _F (V)	I _F =20mA	Over Ux1.2
Reverse current	I _R (uA)	V _R =5V	Over Ux2
Luminous intensity	I _v (mcd)	I _F =20mA	Below SX0.5

Note: 1.U means the upper limit of specified characteristics. S means initial value.

2.Measurment shall be taken between 2 hours and after the test pieces have been returned to normal ambient conditions after completion of each test.

● Soldering :

1. Manual Of Soldering

The temperature of the iron tip should not be higher than 300°C (572°F) and Soldering within 3 seconds per solder-land is to be observed.

2. Reflow Soldering

Preheating : 140°C~160°C ±5°C ,within 2 minutes.

Operation heating : 235°C (Max.) within 10 seconds.(Max)

Gradual Cooling (Avoid quenching).

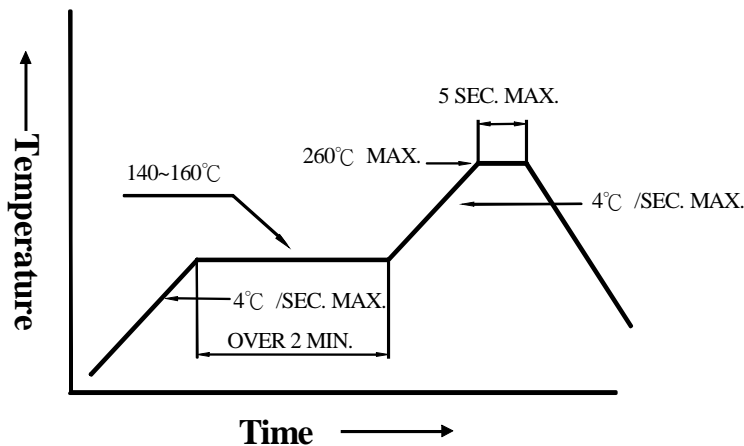

3. DIP soldering (Wave Soldering) :

Preheating : 120°C~150°C,within 120~180 sec.

Operation heating : 245°C±5°C within 5 sec.260°C (Max)

Gradual Cooling (Avoid quenching).

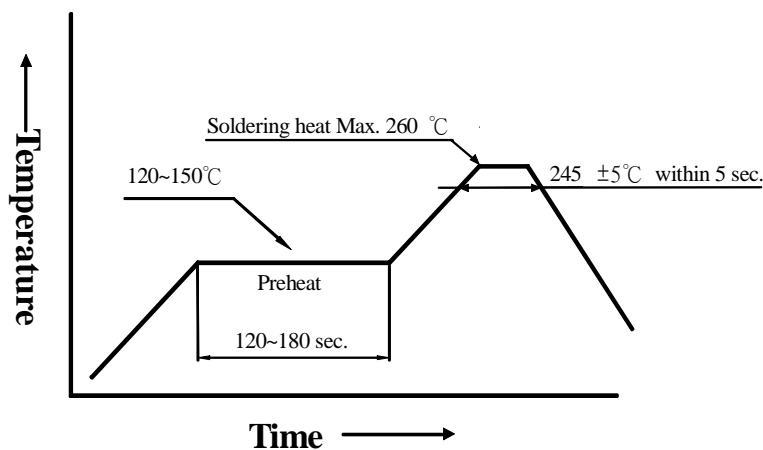

● Handling :

Care must be taken not to cause to the epoxy resin portion of BRIGHT LEDs while it is exposed to high temperature.

Care must be taken not rub the epoxy resin portion of BRIGHT LEDs with hard or sharp article such as the sand blast and the metal hook.

● **Notes for designing:**

Care must be taken to provide the current limiting resistor in the circuit so as to drive the BRIGHT LEDs within the rated figures. Also, caution should be taken not to overload BRIGHT LEDs with instantaneous voltage at the turning ON and OFF of the circuit.

When using the pulse drive care must be taken to keep the average current within the rated figures. Also, the circuit should be designed so as to be subjected to reverse voltage when turning off the BRIGHT LEDs.

● **Storage:**

In order to avoid the absorption of moisture, it is recommended to solder BRIGHT LEDs as soon as possible after unpacking the sealed envelope.

If the envelope is still packed, to store it in the environment as following:

- (1) Temperature : 5°C-30°C (41°F) Humidity : RH 60% Max.
- (2) After this bag is opened, devices that will be applied to infrared reflow, vapor-phase reflow, or equivalent soldering process must be:
 - a. Completed within 24 hours.
 - b. Stored at less than 30% RH.
- (3) Devices require baking before mounting, if:
 - (2) a or (2) b is not met.
- (4) If baking is required, devices must be baked under below conditions:
 - 12 hours at 60°C±3°C.

● **Package and Label of Products:**

- (1) Package: Products are packed in one bag of 3000 pcs (one taping reel) and a label is attached on each bag.
- (2) Label:

