

### Features

- Ultrafast Recovery
- Ultrasoft Recovery
- Very Low  $I_{RRM}$
- Very Low  $Q_{rr}$
- Specified at Operating Conditions
- Lead-Free

### Benefits

- Reduced RFI and EMI
- Reduced Power Loss in Diode and Switching Transistor
- Higher Frequency Operation
- Reduced Snubbing
- Reduced Parts Count

### Description

International Rectifier's HFA16PA120C is a state of the art ultra fast recovery diode. Employing the latest in epitaxial construction and advanced processing techniques it features a superb combination of characteristics which result in performance which is unsurpassed by any rectifier previously available. With basic ratings of 1200 volts and 8 amps continuous current, the HFA16PA120C is especially well suited for use as the companion diode for IGBTs and MOSFETs. In addition to ultra fast recovery time, the HEXFRED product line features extremely low values of peak recovery current ( $I_{RRM}$ ) and does not exhibit any tendency to "snap-off" during the  $t_b$  portion of recovery. The HEXFRED features combine to offer designers a rectifier with lower noise and significantly lower switching losses in both the diode and the switching transistor. These HEXFRED advantages can help to significantly reduce snubbing, component count and heatsink sizes. The HEXFRED HFA16PA120C is ideally suited for applications in power supplies and power conversion systems (such as inverters), motor drives, and many other similar applications where high speed, high efficiency is needed.

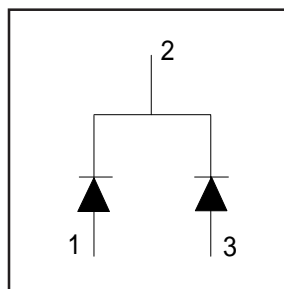

*
$V_R = 1200V$
$V_F (\text{max.}) = 3.3V$
$I_F (AV) = 8.0A$
$I_{RRM} (\text{typ.}) = 4.5A$
* per Leg

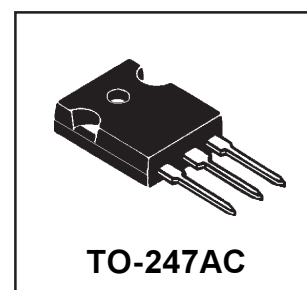

### Absolute Maximum Ratings (per Leg)

	Parameter	Max	Units
$V_R$	Cathode-to-Anode Voltage	1200	V
$I_F @ T_C = 100^\circ C$	Continuous Forward Current	8	A
$I_{FSM}$	Single Pulse Forward Current	130	
$I_{FRM}$	Maximum Repetitive Forward Current	32	
$P_D @ T_C = 25^\circ C$	Maximum Power Dissipation	73.5	W
$P_D @ T_C = 100^\circ C$	Maximum Power Dissipation	29	
$T_J$ $T_{STG}$	Operating Junction and Storage Temperature Range	- 55 to 150	$^\circ C$

# HFA16PA120CPbF

## Electrical Characteristics (per Leg) @ $T_J = 25^\circ\text{C}$ (unless otherwise specified)

Parameter	Min	Typ	Max	Units	Test Conditions
$V_{BR}$ Cathode Anode Breakdown Voltage	1200	-	-	V	$I_R = 100\mu\text{A}$
$V_{FM}$ Max. Forward Voltage	-	2.6	3.3	V	$I_F = 8.0\text{A}$
	-	3.4	4.3		$I_F = 16\text{A}$
	-	2.4	3.1		$I_F = 8.0\text{A}, T_J = 125^\circ\text{C}$
$I_{RM}$ Max. Reverse Leakage Current	-	0.31	10	$\mu\text{A}$	$V_R = V_R$ Rated
	-	135	1000		$T_J = 125^\circ\text{C}, V_R = 0.8 \times V_R$ Rated
$C_T$ Junction Capacitance	-	11	20	pF	$V_R = 200\text{V}$
$L_S$ Series Inductance	-	8.0	-	nH	Measured lead to lead 5mm from pkg

body

## Dynamic Recovery Characteristics (per Leg) @ $T_J = 25^\circ\text{C}$ (unless otherwise specified)

Parameter	Min	Typ	Max	Units	Test Conditions	
$t_{rr}$ Reverse Recovery Time	-	28	-	ns	$I_F = 1.0\text{A}, di_f/dt = 200\text{A}/\mu\text{s}, V_R = 30\text{V}$	
$t_{rr1}$	-	63	95		$T_J = 25^\circ\text{C}$	$I_F = 8.0\text{A}$ $V_R = 200\text{V}$ $di_f/dt = 200\text{A}/\mu\text{s}$
$t_{rr2}$	-	106	160		$T_J = 125^\circ\text{C}$	
$I_{RRM1}$ Peak Recovery Current	-	4.5	8.0	A	$T_J = 25^\circ\text{C}$	
	$I_{RRM2}$	-	6.2		11	
$Q_{rr1}$ Reverse Recovery Charge	-	140	380	nC	$T_J = 25^\circ\text{C}$	
	$Q_{rr2}$	-	335		880	
$di_{(rec)M}/dt1$ Peak Rate of Recovery	-	133	-	A/ $\mu\text{s}$	$T_J = 25^\circ\text{C}$	
$di_{(rec)M}/dt2$ Current During $t_b$	-	85	-		$T_J = 125^\circ\text{C}$	

## Thermal - Mechanical Characteristics

Parameter	Min	Typ	Max	Units
$T_{lead} \text{ ①}$ Lead Temperature	-	-	300	$^\circ\text{C}$
$R_{thJC}$ Thermal Resistance, Junction to Case	-	-	1.7	k/W
$R_{thJA} \text{ ②}$ Thermal Resistance, Junction to Ambient	-	-	40	
$R_{thCS} \text{ ③}$ Thermal Resistance, Case to Heat Sink	-	0.25	-	
$Wt$ Weight	-	6.0	-	g
	-	0.21	-	(oz)
Mounting Torque	6.0	-	12	Kg-cm
	5.0	-	10	lbf-in

① 0.063 in. from Case (1.6mm) for 10 sec

② Typical Socket Mount

③ Mounting Surface, Flat, Smooth and Greased

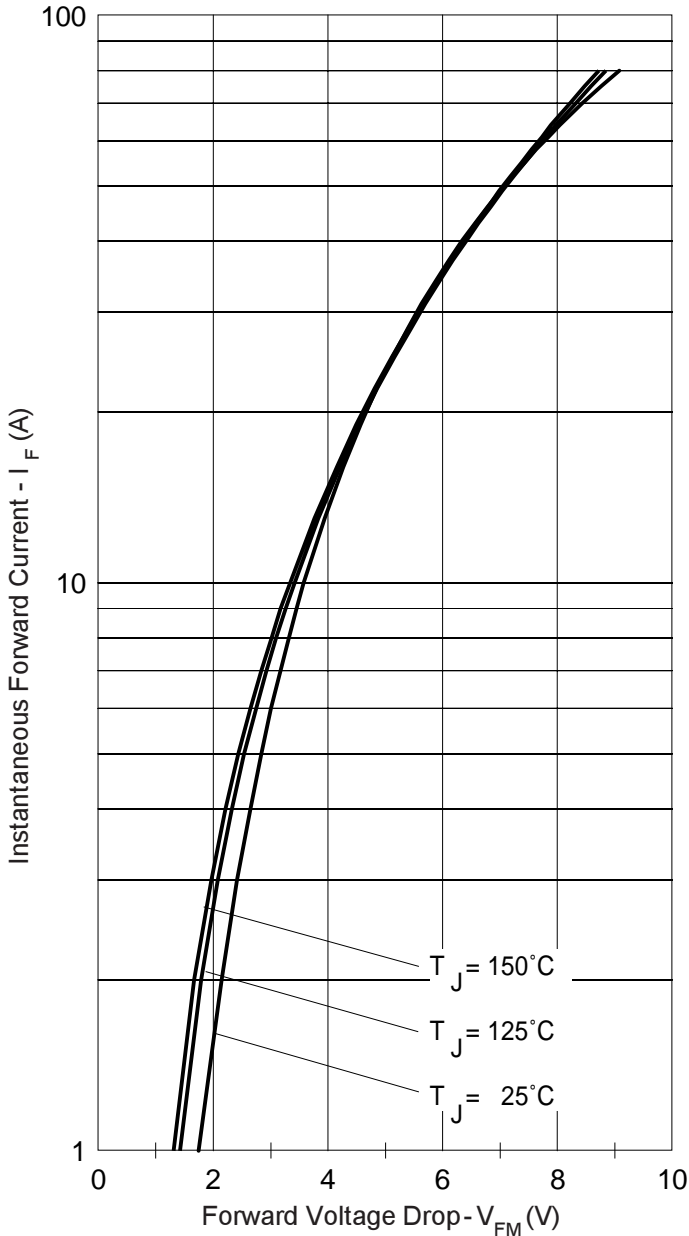

Fig. 1 - Max. Forward Voltage Drop Characteristics

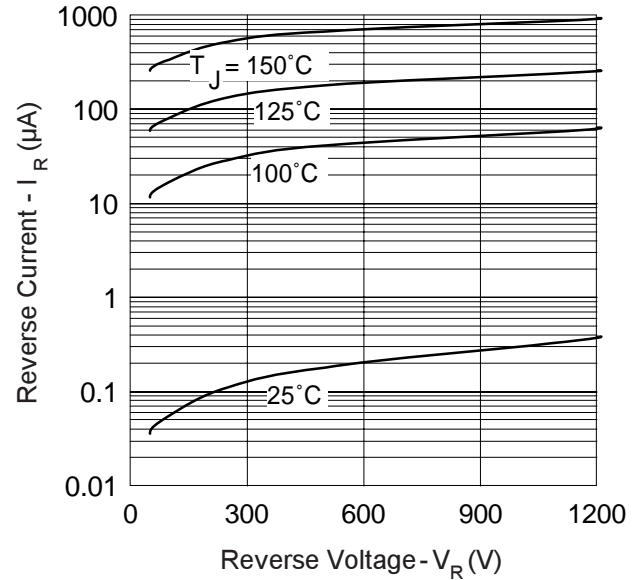

Fig. 2 - Typ. Values Of Reverse Current Vs. Reverse Voltage

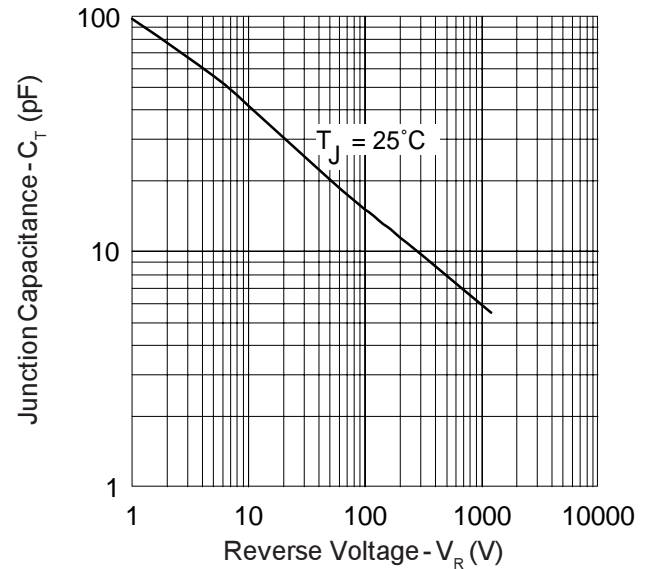

Fig. 3 - Typical Junction Capacitance Vs. Reverse Voltage

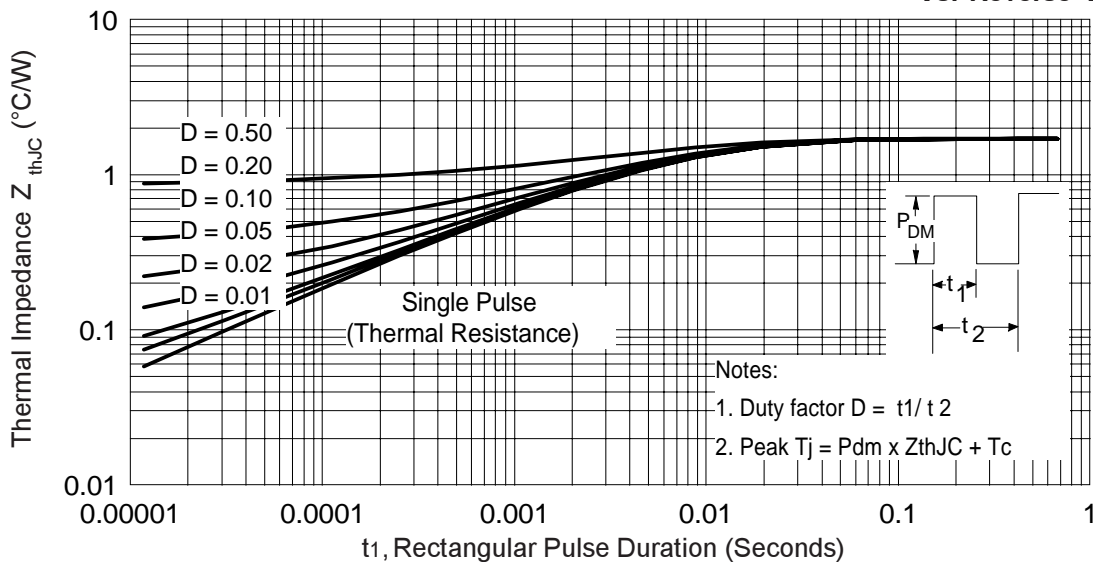
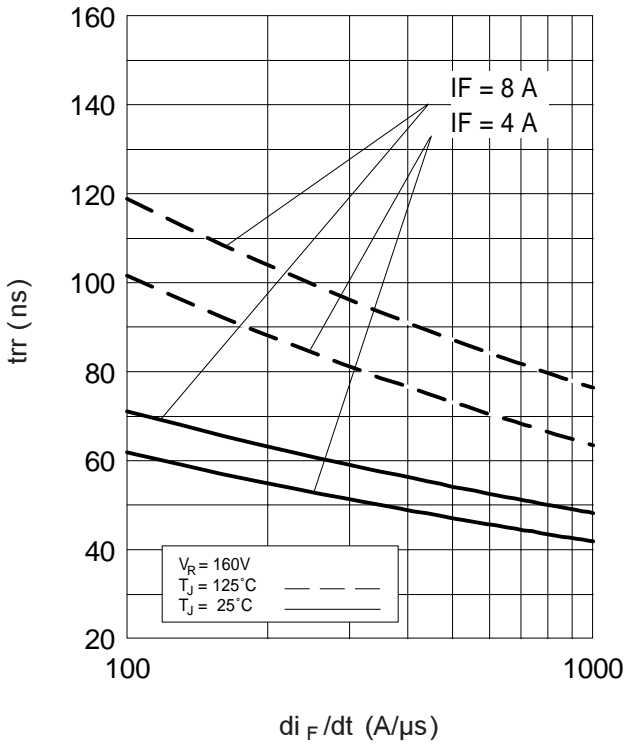
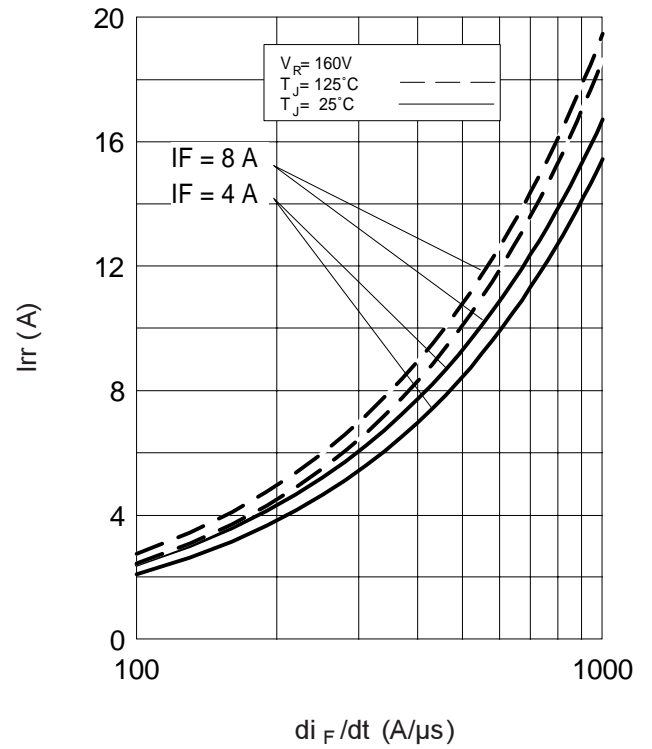

Fig. 4 - Max. Thermal Impedance  $Z_{thJC}$  Characteristics



**Fig. 5 - Typical Reverse Recovery Vs.  $di_f/dt$**



**Fig. 6 - Typical Recovery Current Vs.  $di_f/dt$**

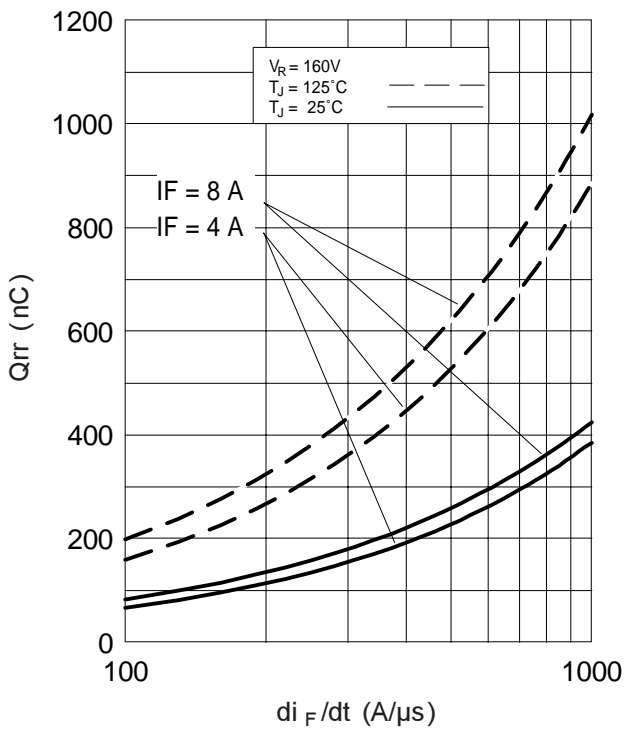

**Fig. 8 - Typical Stored Charge vs.  $di_f/dt$**

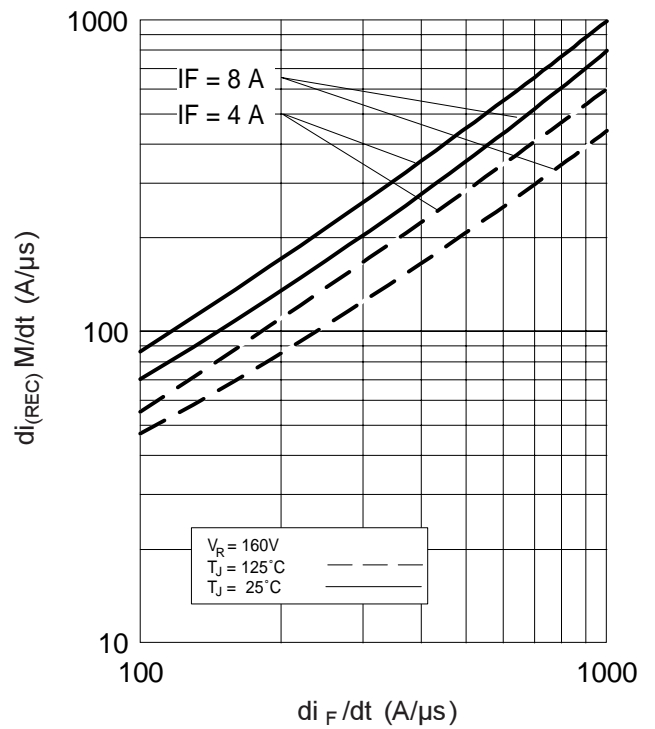

**Fig. 7 - Typical  $di_{(REC)} M/dt$  vs.  $di_f/dt$**

Reverse Recovery Circuit

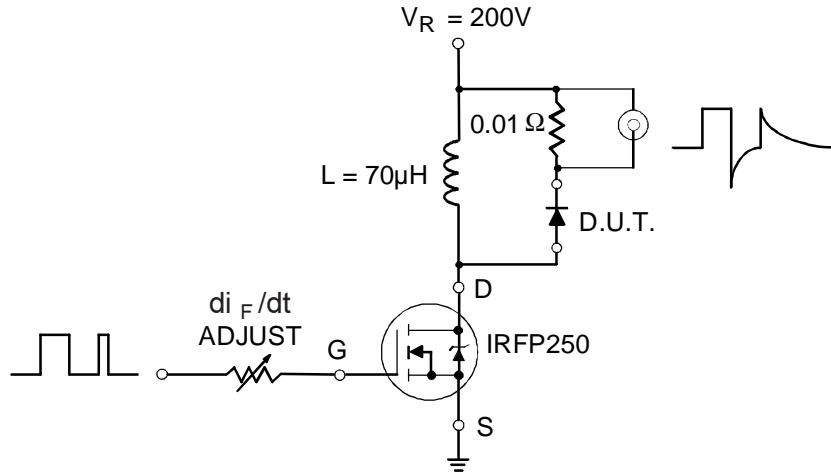
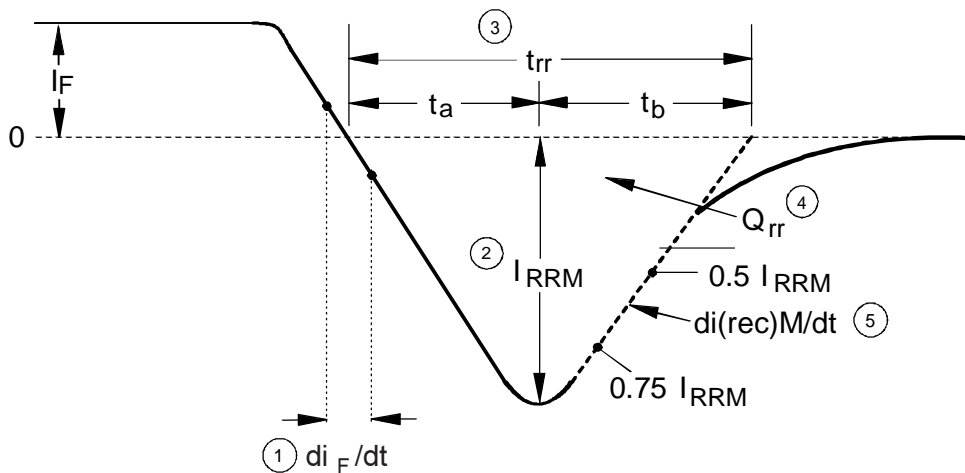

Fig. 9- Reverse Recovery Parameter Test Circuit



1.  $di_F/dt$  - Rate of change of current through zero crossing

2.  $I_{RRM}$  - Peak reverse recovery current

3.  $t_{rr}$  - Reverse recovery time measured from zero crossing point of negative going  $I_F$  to point where a line passing through  $0.75 I_{RRM}$  and  $0.50 I_{RRM}$  extrapolated to zero current

4.  $Q_{rr}$  - Area under curve defined by  $t_{rr}$  and  $I_{RRM}$

$$Q_{rr} = \frac{t_{rr} \times I_{RRM}}{2}$$

5.  $di(\text{rec})M/dt$  - Peak rate of change of current during  $t_b$  portion of  $t_{rr}$

Fig. 10 - Reverse Recovery Waveform and Definitions

## TO-247AC Package Outline

Dimensions are shown in millimeters (inches)

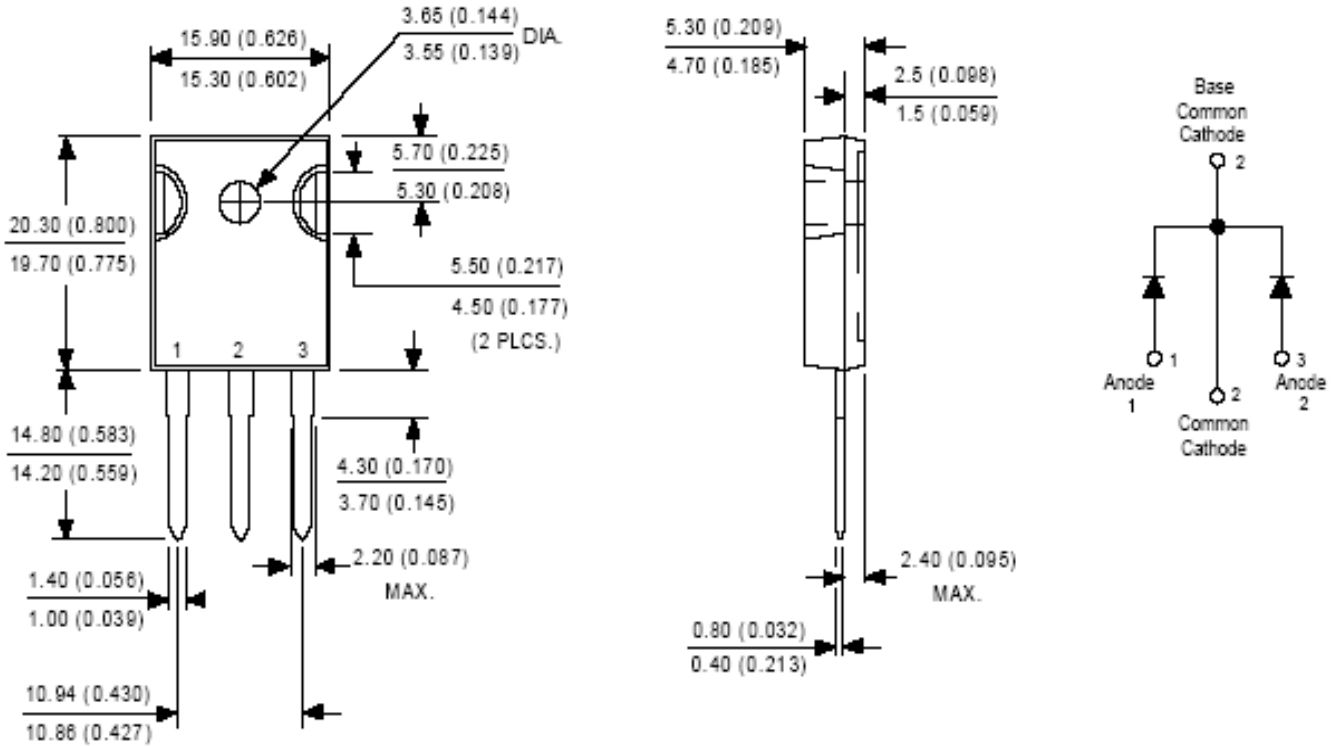

Conform to JEDEC outline TO-247AC (TO-3P)  
Dimensions in millimeters and (inches)

## TO-247AC Part Marking Information

EXAMPLE: THIS IS A HFA16PA60C  
WITH ASSEMBLY  
LOT CODE 5657  
ASSEMBLED ON WW 35, 2000  
IN ASSEMBLY LINE "H"

Note: "P" in the beginning of date code  
indicates "Lead-Free"

