

GaAs PHEMT MMIC LOW NOISE AMPLIFIER, DC - 20 GHz



Typical Applications

The HMC460LC5 is ideal for:

- Telecom Infrastructure
- Microwave Radio & VSAT
- Military & Space
- Test Instrumentation

Features

- Noise Figure: 2.5 dB @ 10 GHz
- Gain: 14 dB @ 10 GHz
- P1dB Output Power: +16.5 dBm @ 10 GHz
- Supply Voltage: +8V @ 75 mA
- 50 Ohm Matched Input/Output
- 32 Lead Ceramic 5x5mm SMT Package: 25mm²

Functional Diagram

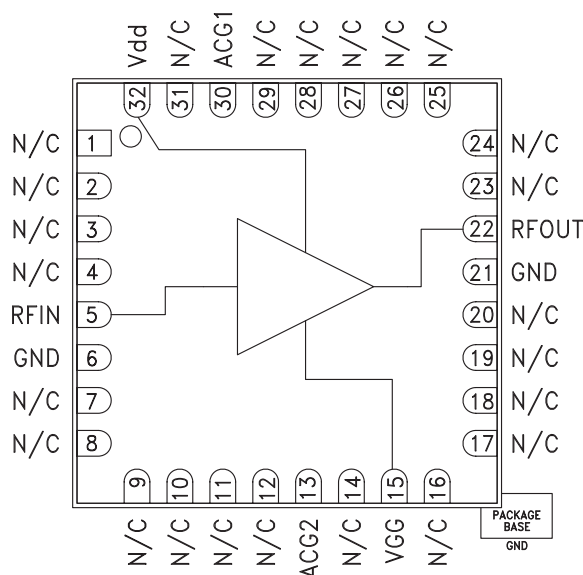

General Description

The HMC460LC5 is a GaAs MMIC PHEMT Low Noise Distributed Amplifier in a leadless 5x5 mm ceramic surface mount package which operates from DC to 20 GHz. The amplifier provides 14 dB of gain, 2.5 dB noise figure and +16.5 dBm of output power at 1 dB gain compression while requiring only 75 mA from a Vdd = 8V supply. Gain flatness is excellent from DC to 20 GHz making the HMC460LC5 ideal for EW, ECM, Radar and test equipment applications. The wideband amplifier I/Os are internally matched to 50 Ohms.

Electrical Specifications, $T_A = +25^\circ \text{C}$, $V_{dd} = 8\text{V}$, $I_{dd} = 75 \text{mA}^*$

Parameter	Min.	Typ.	Max.	Min.	Typ.	Max.	Min.	Typ.	Max.	Units
Frequency Range		DC - 6.0		6.0 - 18.0			18.0 - 20.0			GHz
Gain	11	14		11	14		10	13		dB
Gain Flatness		± 0.5			± 0.15			± 0.25		dB
Gain Variation Over Temperature		0.008			0.01			0.01		dB/°C
Noise Figure		3.5	5.0		2.5	4.0		3.5	5	dB
Input Return Loss		17			18			12		dB
Output Return Loss		17			15			15		dB
Output Power for 1 dB Compression (P1dB)	14	17		13	16		12	15		dBm
Saturated Output Power (P _{sat})		18			18			17		dBm
Output Third Order Intercept (IP3)		29.5			29			28.5		dBm
Supply Current (I _{dd}) (V _{dd} = 8V, V _{gg} = -0.9V Typ.)		75			75			75		mA

* Adjust V_{gg} between -2 to 0V to achieve I_{dd}= 75 mA typical.

For price, delivery, and to place orders, please contact Hittite Microwave Corporation:
20 Alpha Road, Chelmsford, MA 01824 Phone: 978-250-3343 Fax: 978-250-3373
Order On-line at www.hittite.com



**GaAs PHEMT MMIC LOW NOISE
AMPLIFIER, DC - 20 GHz**

Broadband Gain & Return Loss

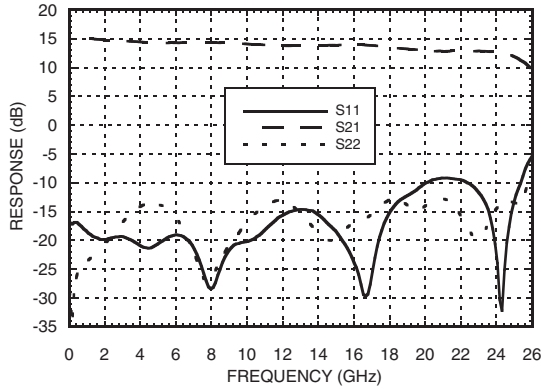

Gain vs. Temperature

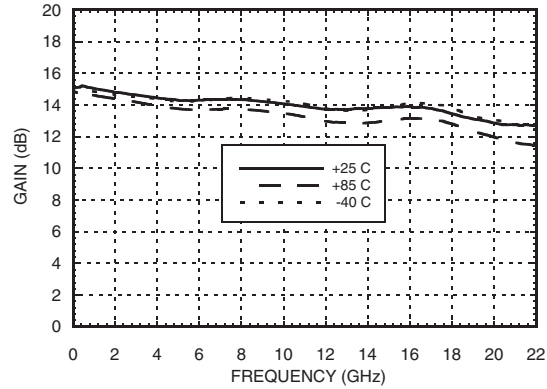

Input Return Loss vs. Temperature

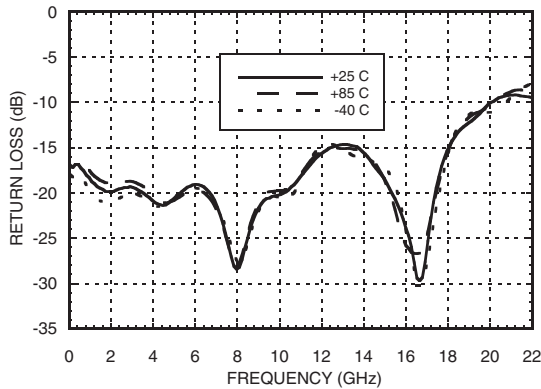

Output Return Loss vs. Temperature

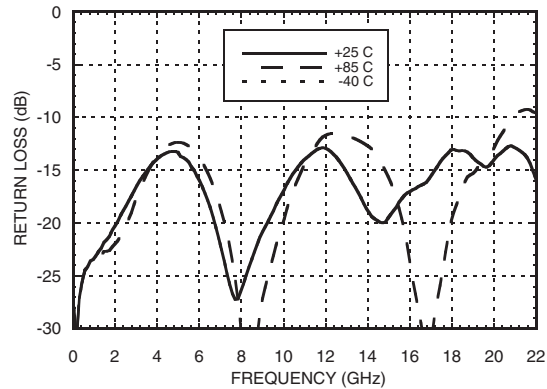

Low Frequency Gain & Return Loss

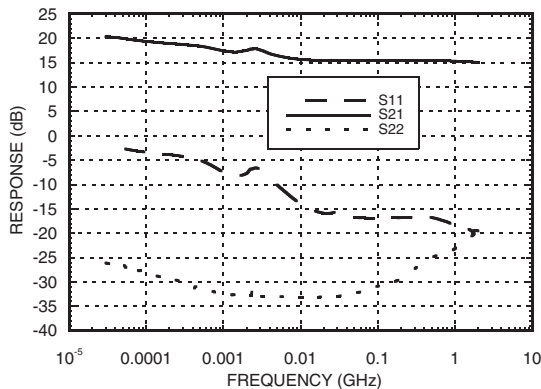

Noise Figure vs. Temperature

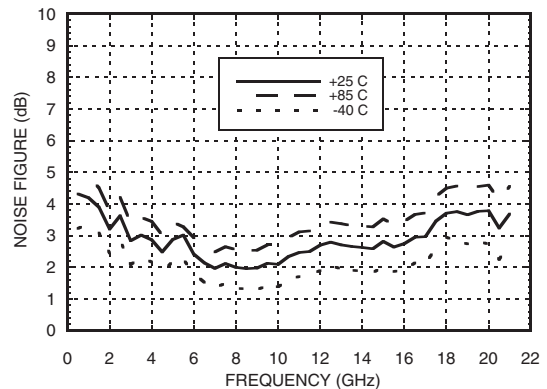



P1dB vs. Temperature

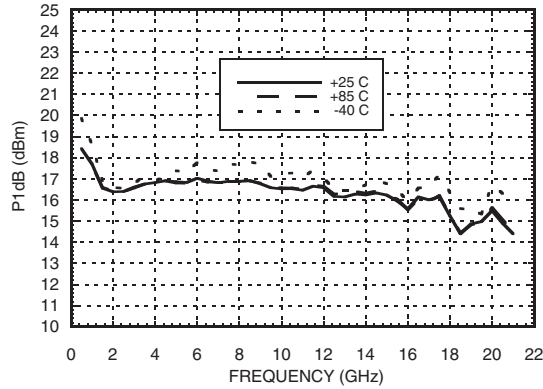

Psat vs. Temperature

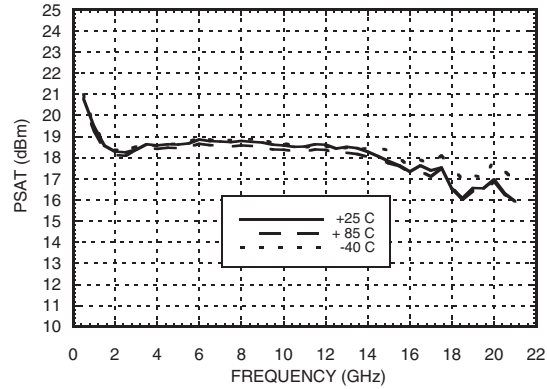

Output IP3 vs. Temperature

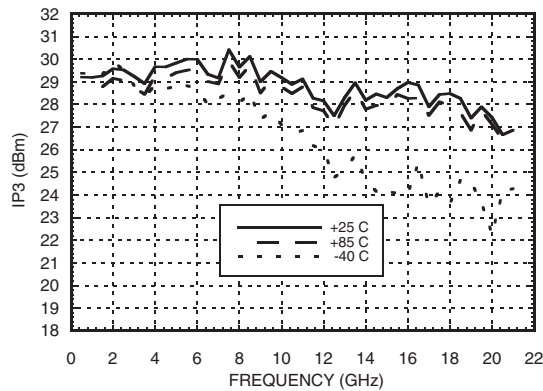

**Gain, Power & Noise Figure
vs. Supply Voltage @ 10 GHz, Fixed Vgg**

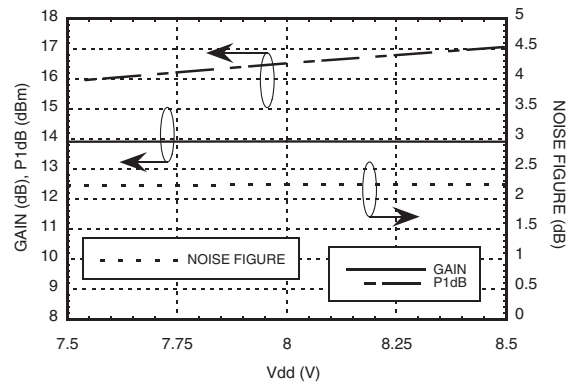

Reverse Isolation vs. Temperature

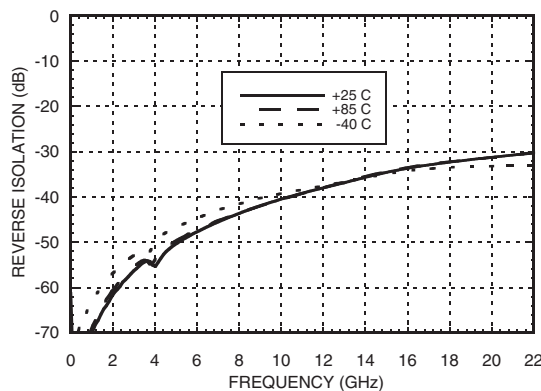

Absolute Maximum Ratings

Drain Bias Voltage (Vdd)	+9 Vdc
Gate Bias Voltage (Vgg1)	-2 to 0 Vdc
RF Input Power (RFIN)(Vdd = +8 Vdc)	+10 dBm
Channel Temperature	175 °C
Continuous Pdiss (T = 85 °C) (derate 23 mW/°C above 85 °C)	2 W
Thermal Resistance (channel to die bottom)	44.4 °C/W
Storage Temperature	-65 to +150 °C
Operating Temperature	-55 to +85 °C

Typical Supply Current vs. Vdd

Vdd (V)	Idd (mA)
+7.5	74
+8.0	75
+8.5	76



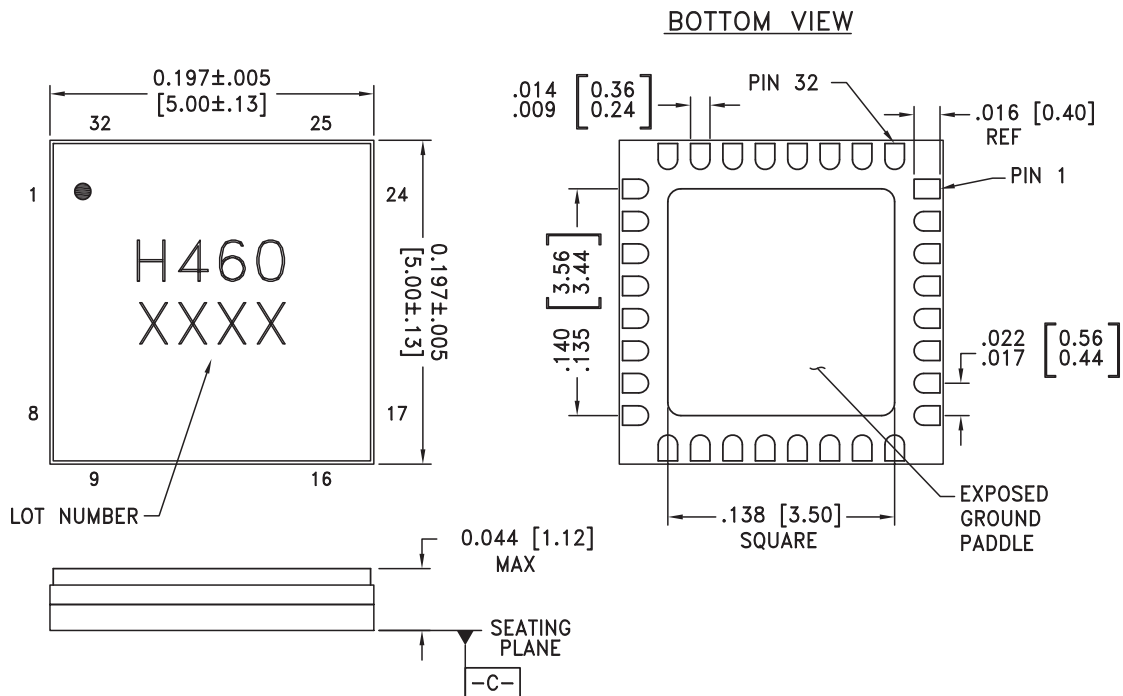

**ELECTROSTATIC SENSITIVE DEVICE
OBSERVE HANDLING PRECAUTIONS**

Outline Drawing

NOTES:

1. PACKAGE BODY MATERIAL: ALUMINA
2. LEAD AND GROUND PADDLE PLATING:
30-80 MICROINCHES GOLD OVER 50 MICROINCHES MINIMUM NICKEL.
3. DIMENSIONS ARE IN INCHES [MILLIMETERS].
4. LEAD SPACING TOLERANCE IS NON-CUMULATIVE.
5. PACKAGE WARP SHALL NOT EXCEED 0.05mm DATUM -C-
6. ALL GROUND LEADS AND GROUND PADDLE MUST BE SOLDERED TO PCB RF GROUND.

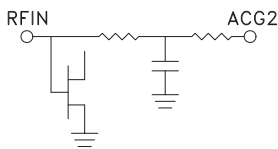

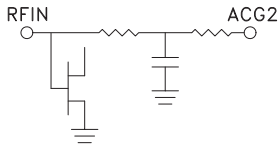
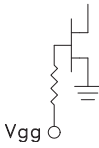
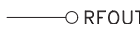
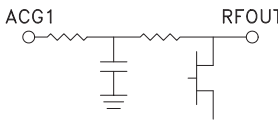
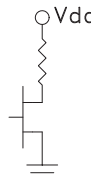
Pin Descriptions

Pin Number	Function	Description	Interface Schematic
1 - 4, 7 - 12, 14, 16 - 20, 23 - 29, 31	N/C	No connection. These pins may be connected to RF ground. Performance will not be affected.	
5	RFIN	This pin is DC coupled and matched to 50 Ohms.	
6, 21	GND	Package bottom must be connected to RF/DC ground.	
13	ACG2	Low frequency termination. Attach bypass capacitor per application circuit herein.	
15	Vgg	Gate control for amplifier. Adjust to achieve I _{dd} = 75 mA.	
22	RFOUT	This pin is DC coupled and matched to 50 Ohms.	
30	ACG1	Low frequency termination. Attach bypass capacitor per application circuit herein.	
32	Vdd	Power supply voltage for the amplifier. External bypass capacitors are required	



Application Circuit

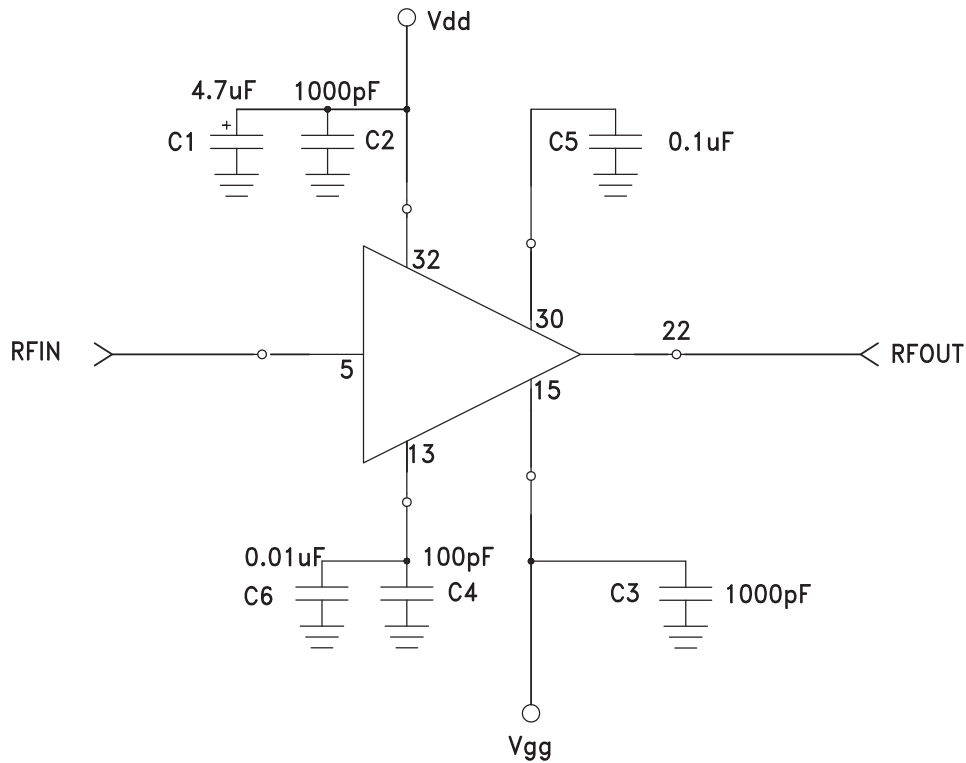



Evaluation PCB

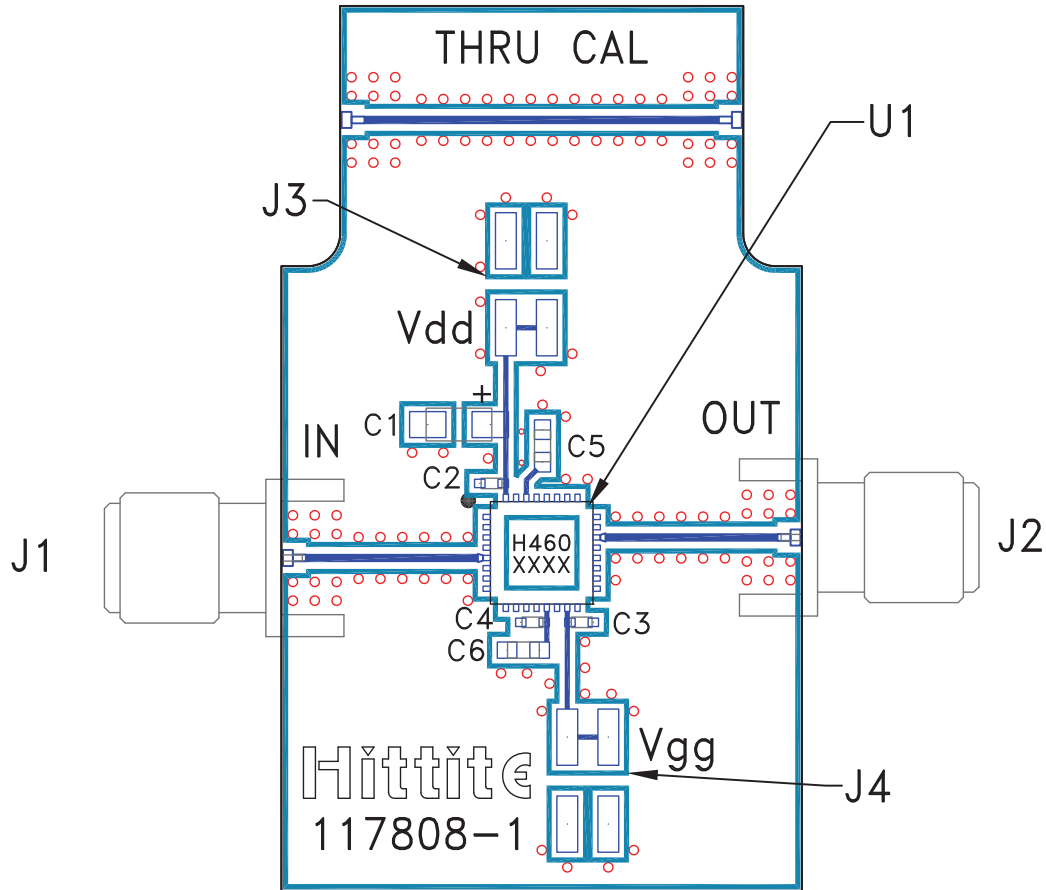

List of Materials for Evaluation PCB 117810 [1]

Item	Description
J1 - J2	PCB Mount SMA Connector
J3 - J4	2 mm Molex Header
C4	100 pF Capacitor, 0402 Pkg.
C2, C3	1000 pF Capacitor, 0402 Pkg.
C1	4.7 μ F Capacitor, Tantalum
C5	0.1 μ F Capacitor, 0603 Pkg.
C6	0.01 μ F Capacitor, 0603 Pkg.
U1	HMC460LC5
PCB [2]	117810 Evaluation PCB

The circuit board used in the final application should use RF circuit design techniques. Signal lines should have 50 ohm impedance while the package ground leads and package bottom should be connected directly to the ground plane similar to that shown. A sufficient number of via holes should be used to connect the top and bottom ground planes. The evaluation board should be mounted to an appropriate heat sink. The evaluation circuit board shown is available from Hittite upon request.

[1] Reference this number when ordering complete evaluation PCB

[2] Circuit Board Material: Rogers 4350



Notes: