

300MHz Low Noise Amplifiers

The EL5130 and EL5131 are ultra-low voltage noise, high speed voltage feedback amplifiers that are ideal for applications requiring low voltage noise, including communications and imaging. These devices offer extremely low power consumption for exceptional noise performance. Stable at gains as low as 5, these devices offer 100mA of drive performance. Not only do these devices find perfect application in high gain applications, they maintain their performance down to lower gain settings.

These amplifiers are available in small package options (SOT-23) as well as the industry-standard SOIC packages. All parts are specified for operation over the -40°C to +85°C temperature range.

Ordering Information

PART NUMBER	PART MARKING	TAPE & REEL	PACKAGE	PKG. DWG. #
EL5130IS	5130IS	-	8 Ld SOIC (150 mil)	MDP0027
EL5130ISZ (Note)	5130ISZ	-	8 Ld SOIC (150 mil) (Pb-free)	MDP0027
EL5130IS-T7	5130IS	7"	8 Ld SOIC (150 mil)	MDP0027
EL5130ISZ-T7 (Note)	5130ISZ	7"	8 Ld SOIC (150 mil) (Pb-free)	MDP0027
EL5130IS-T13	5130IS	13"	8 Ld SOIC (150 mil)	MDP0027
EL5130ISZ-T13 (Note)	5130ISZ	13"	8 Ld SOIC (150 mil) (Pb-free)	MDP0027
EL5131IW-T7	BBAA	7" (3k pcs)	5 Ld SOT-23	MDP0038
EL5131IWZ-T7 (Note)	BRAA	7" (3k pcs)	5 Ld SOT-23 (Pb-free)	MDP0038
EL5131IW-T7A	BBAA	7" (250 pcs)	5 Ld SOT-23	MDP0038
EL5131IWZ-T7A (Note)	BRAA	7" (250 pcs)	5 Ld SOT-23 (Pb-free)	MDP0038

NOTE: Intersil Pb-free plus anneal products employ special Pb-free material sets; molding compounds/die attach materials and 100% matte tin plate termination finish, which are RoHS compliant and compatible with both SnPb and Pb-free soldering operations. Intersil Pb-free products are MSL classified at Pb-free peak reflow temperatures that meet or exceed the Pb-free requirements of IPC/JEDEC J STD-020.

Features

- 300MHz -3dB bandwidth
- Ultra low noise = 1.8nV/√Hz
- 350V/μs slew rate
- Low supply current = 4mA
- Single supplies from 5V to 12V
- Dual supplies from ±2.5V to ±6V
- Fast disable on the EL5130
- Low cost
- Pb-free plus anneal available (RoHS compliant)

Applications

- Imaging
- Instrumentation
- Communications devices

Pinouts

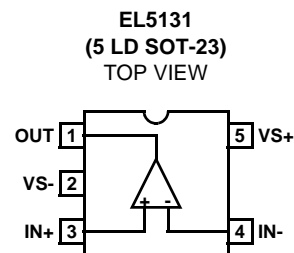
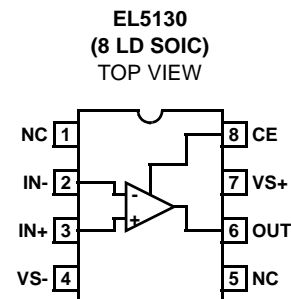

EL5130, EL5131

Absolute Maximum Ratings ($T_A = +25^\circ\text{C}$)

Slewrates between V_{S+} and V_{S-}	1V/ μs
Supply Voltage from V_{S+} to V_{S-}	13.2V
I_{IN-} , I_{IN+} , CE	$\pm 5\text{mA}$
Continuous Output Current	100mA

Thermal Information

Storage Temperature	-65°C to $+125^\circ\text{C}$
Ambient Operating Temperature	-40°C to $+85^\circ\text{C}$
Operating Junction Temperature	$+125^\circ\text{C}$
Power Dissipation	See Curves
Pb-free reflow profile	see link below
	http://www.intersil.com/pbfree/Pb-FreeReflow.asp

CAUTION: Stresses above those listed in "Absolute Maximum Ratings" may cause permanent damage to the device. This is a stress only rating and operation of the device at these or any other conditions above those indicated in the operational sections of this specification is not implied.

IMPORTANT NOTE: All parameters having Min/Max specifications are guaranteed. Typical values are for information purposes only. Unless otherwise noted, all tests are at the specified temperature and are pulsed tests, therefore: $T_J = T_C = T_A$

Electrical Specifications $V_{S+} = +5\text{V}$, $V_{S-} = -5\text{V}$, $R_L = 500\Omega$, $R_G = 50\Omega$, $C_L = 5\text{pF}$, $T_A = +25^\circ\text{C}$, Unless Otherwise Specified.

PARAMETER	DESCRIPTION	CONDITIONS	MIN	TYP	MAX	UNIT
V_{OS}	Offset Voltage		-0.9	0.2	0.9	mV
$T_C V_{OS}$	Offset Voltage Temperature Coefficient	Measured from T_{MIN} to T_{MAX}		0.8		$\mu\text{V}/^\circ\text{C}$
I_B	Input Bias Current	$V_{IN} = 0\text{V}$	1.5	2.27	3.3	μA
I_{OS}	Input Offset Current	$V_{IN} = 0\text{V}$	-500	100	500	nA
$T_C I_{OS}$	Input Bias Current Temperature Coefficient	Measured from T_{MIN} to T_{MAX}		-3		$\text{nA}/^\circ\text{C}$
PSRR	Power Supply Rejection Ratio	$V_S = \pm 4.75\text{V}$ to $\pm 5.25\text{V}$	75	90		dB
CMRR	Common Mode Rejection Ratio	$V_{IN} = \pm 3.0\text{V}$	95	110		dB
CMIR	Common Mode Input Range	Guaranteed by CMRR test	± 3	± 3.3		V
R_{IN}	Input Resistance	Common mode	5	20		$\text{M}\Omega$
C_{IN}	Input Capacitance			1		pF
I_S	Supply Current		3.0	3.54	4.1	mA
AVOL	Open Loop Gain	$V_{OUT} = \pm 2.5\text{V}$, $R_L = 1\text{k}\Omega$ to GND	10	16		kV/V
V_O	Output Voltage Swing	$R_L = 1\text{k}\Omega$, $R_F = 900\Omega$, $R_G = 100\Omega$	± 3.5	± 3.8		V
		$R_L = 150\Omega$	± 3.5	± 3.3		V
I_{SC}	Short Circuit Current	$R_L = 10\Omega$	50	100		mA
BW	-3dB Bandwidth	$A_V = +5$, $R_L = 500\Omega$		300		MHz
BW	$\pm 0.1\text{dB}$ Bandwidth	$A_V = +5$, $R_L = 500\Omega$		60		MHz
GBWP	Gain Bandwidth Product			1500		MHz
PM	Phase Margin	$R_L = 1\text{k}\Omega$, $C_L = 6\text{pF}$		55		$^\circ$
SR	Slew Rate	$V_S = \pm 5\text{V}$, $R_L = 150\Omega$, $V_{OUT} = \pm 2.5\text{V}$	225	350		V/ μs
t_R , t_F	Rise Time, Fall Time	$\pm 0.1V_{STEP}$		TBD		ns
t_{PD}	Propagation Delay	$\pm 0.1V_{STEP}$		TBD		ns
t_S	0.01% Settling Time			14		ns
dG	Differential Gain	$A_V = +2$, $R_F = 1\text{k}\Omega$		0.01		%
dP	Differential Phase	$A_V = +2$, $R_F = 1\text{k}\Omega$		0.01		$^\circ$
e_N	Input Noise Voltage	$f = 10\text{kHz}$		1.8		$\text{nV}/\sqrt{\text{Hz}}$
i_N	Input Noise Current	$f = 10\text{kHz}$		1.1		$\text{pA}/\sqrt{\text{Hz}}$

Typical Performance Curves

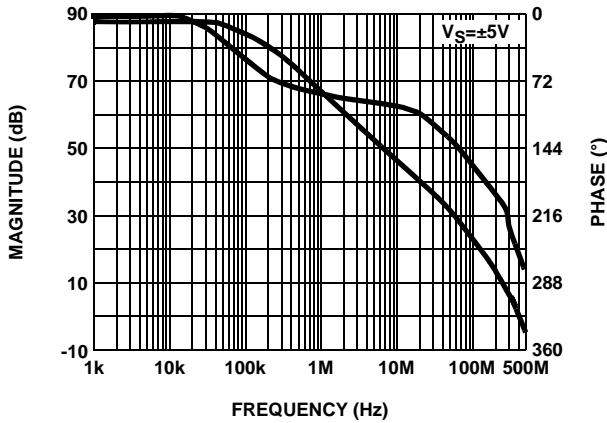

FIGURE 1. OPEN LOOP GAIN AND PHASE vs FREQUENCY

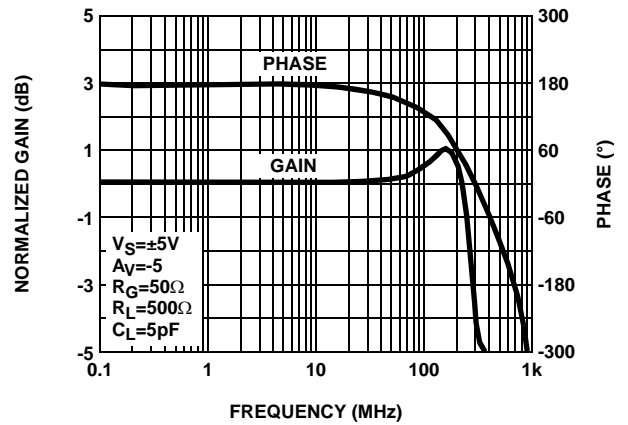

FIGURE 2. GAIN AND PHASE vs FREQUENCY (INVERTING)

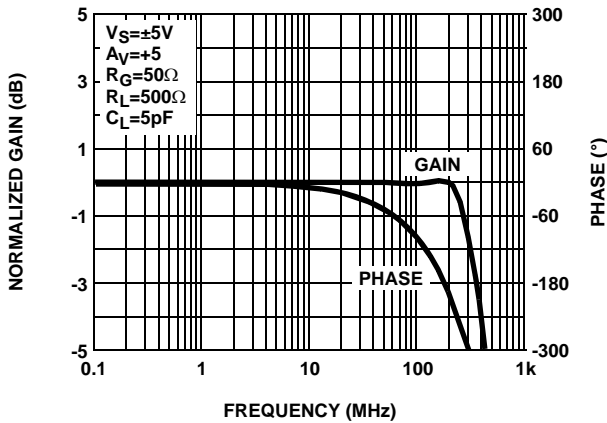

FIGURE 3. GAIN AND PHASE vs FREQUENCY (NON-INVERTING)

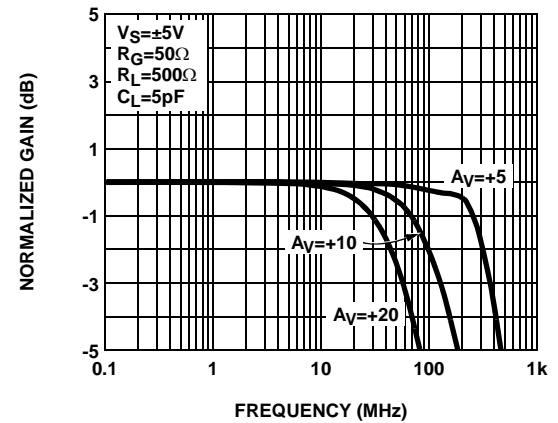

FIGURE 4. GAIN vs FREQUENCY FOR VARIOUS A_{V+}

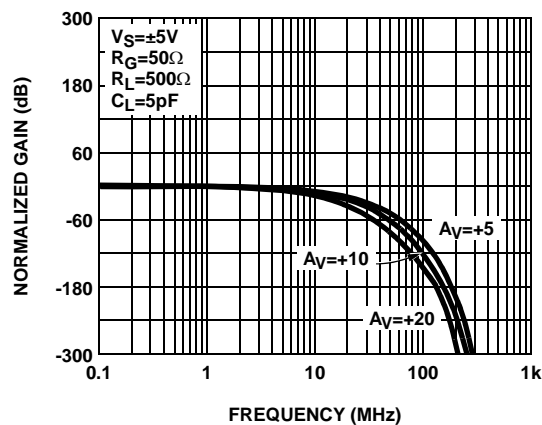

FIGURE 5. PHASE vs FREQUENCY FOR VARIOUS A_{V+}

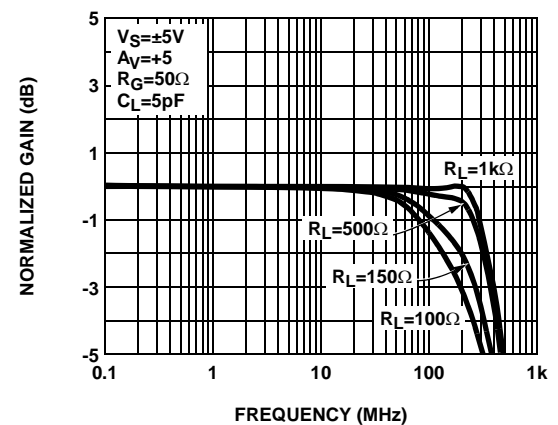

FIGURE 6. GAIN vs FREQUENCY FOR VARIOUS R_L ($A_{V+} = +5$)

Typical Performance Curves

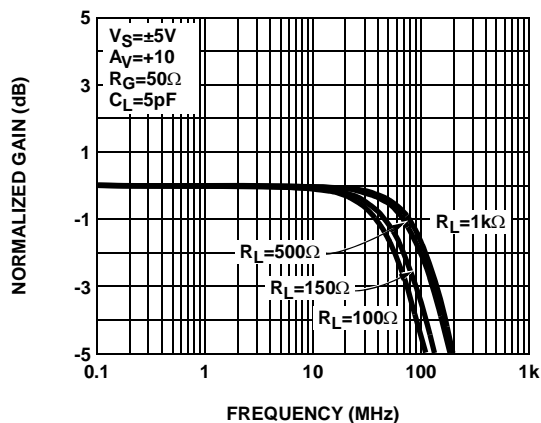

FIGURE 7. GAIN vs FREQUENCY FOR VARIOUS R_L ($A_V = +10$)

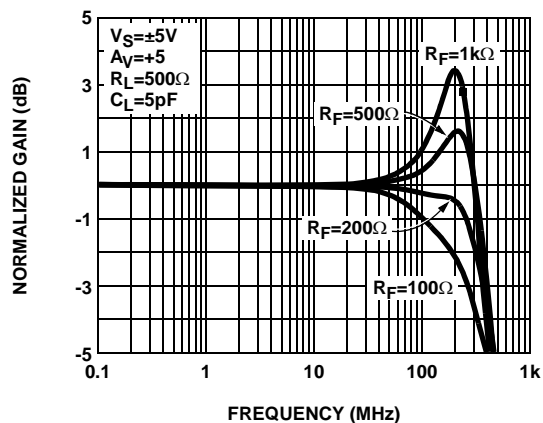

FIGURE 8. GAIN vs FREQUENCY FOR VARIOUS R_F ($A_V = +5$)

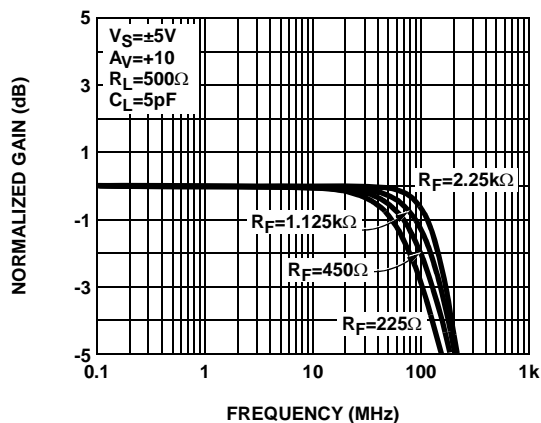

FIGURE 9. GAIN vs FREQUENCY FOR VARIOUS R_F ($A_V = +10$)

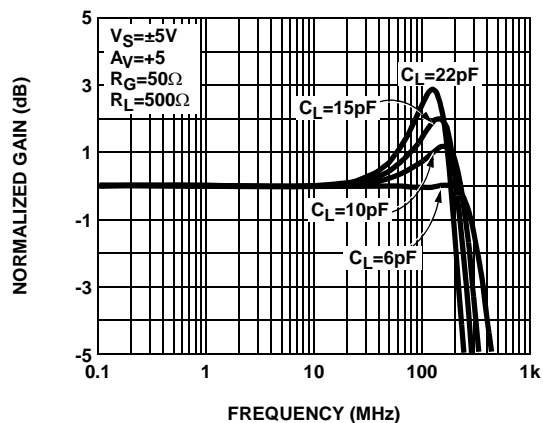

FIGURE 10. GAIN vs FREQUENCY FOR VARIOUS C_L ($A_V = +5$)

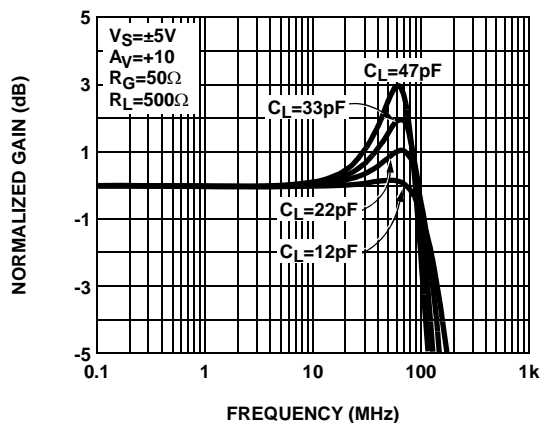

FIGURE 11. GAIN vs FREQUENCY FOR VARIOUS C_L ($A_V = +10$)

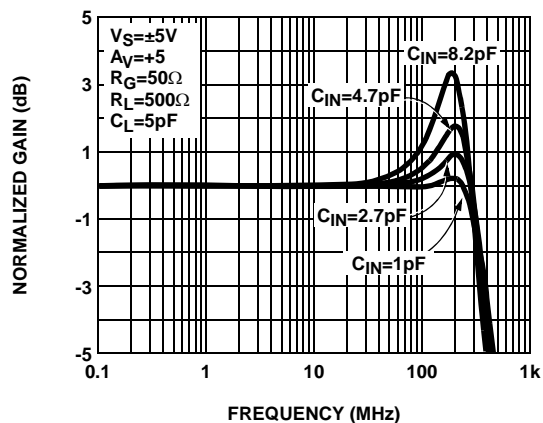

FIGURE 12. GAIN vs FREQUENCY FOR VARIOUS C_{IN-} ($A_V = +5$)

Typical Performance Curves

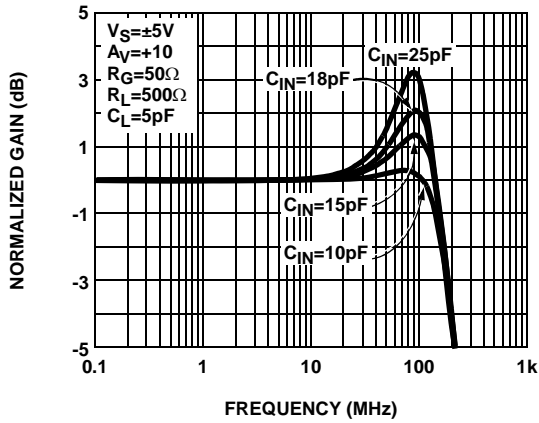

FIGURE 13. GAIN vs FREQUENCY FOR VARIOUS C_{IN} ($A_V=+10$)

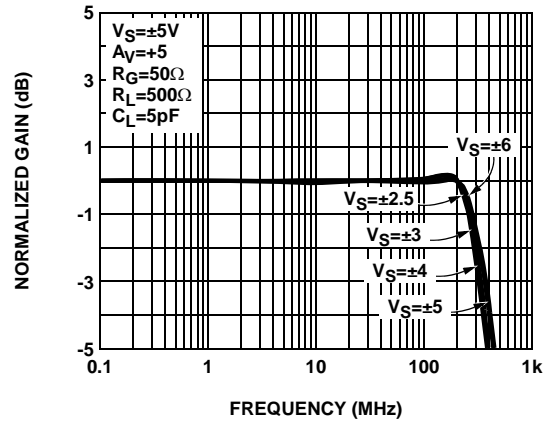

FIGURE 14. GAIN vs FREQUENCY FOR VARIOUS $\pm V_S$ ($A_V=+5$)

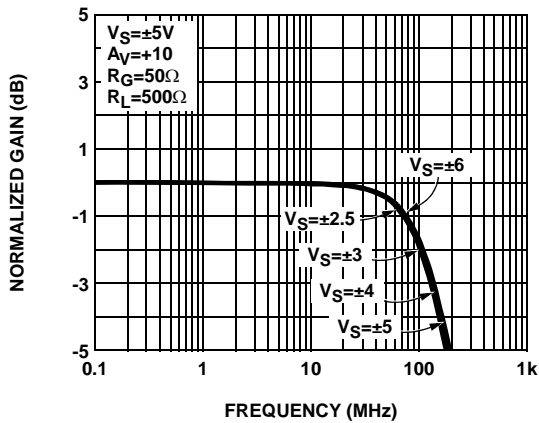

FIGURE 15. GAIN vs FREQUENCY FOR VARIOUS $V_{S\pm}$ ($A_V=+10$)

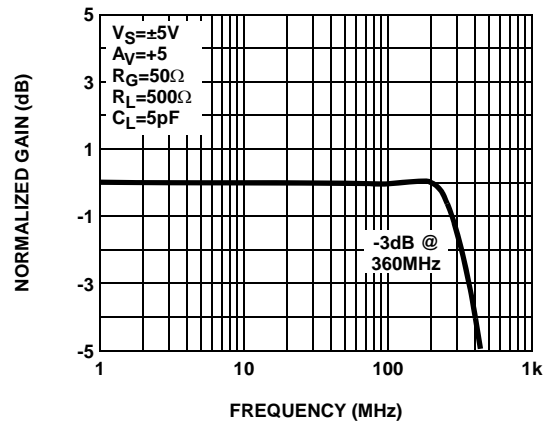

FIGURE 16. FREQUENCY RESPONSE (-3dB ROLL-OFF)

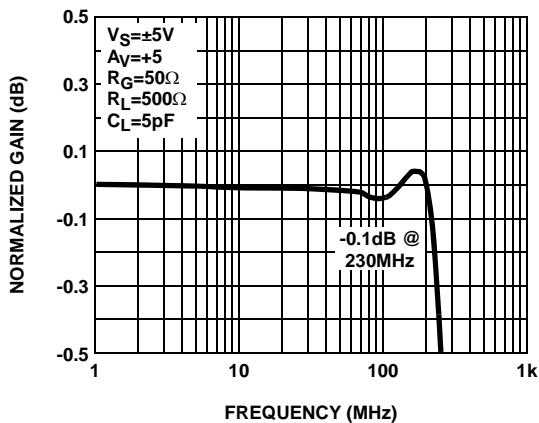

FIGURE 17. FREQUENCY RESPONSE (0.1dB GAIN FLATNESS)

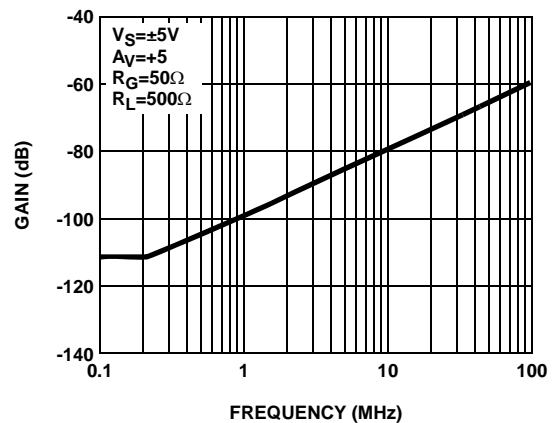

FIGURE 18. INPUT AND OUTPUT ISOLATION FOR DISABLE AMPLIFIER

Typical Performance Curves

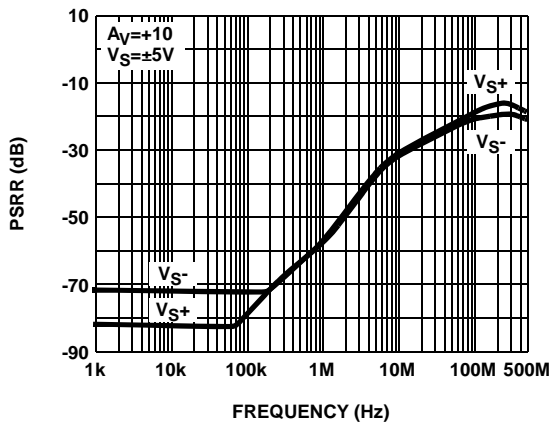

FIGURE 19. PSRR vs FREQUENCY

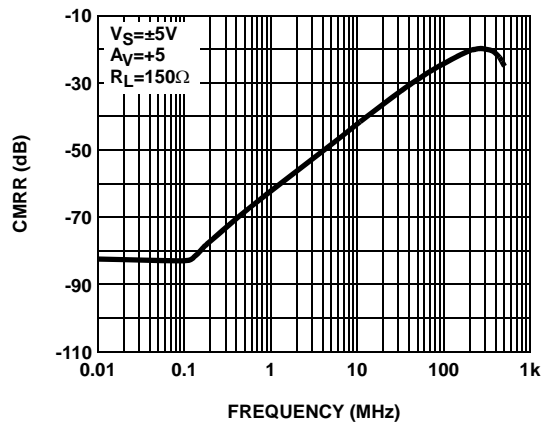

FIGURE 20. CMRR vs FREQUENCY

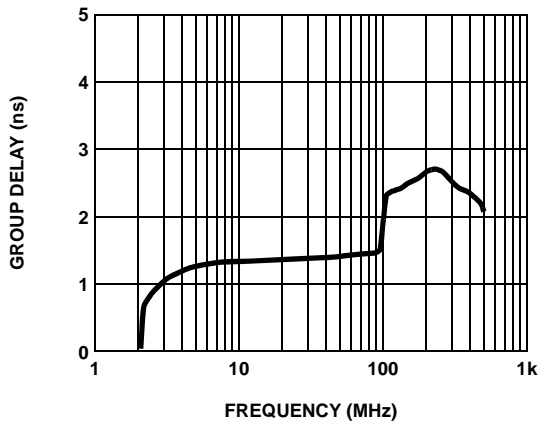

FIGURE 21. GROUP DELAY vs FREQUENCY

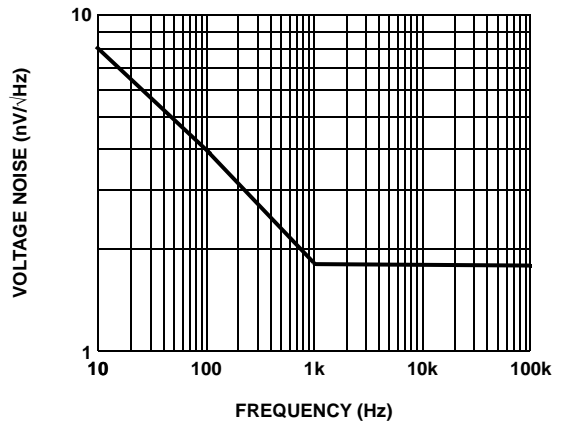

FIGURE 22. INPUT VOLTAGE NOISE

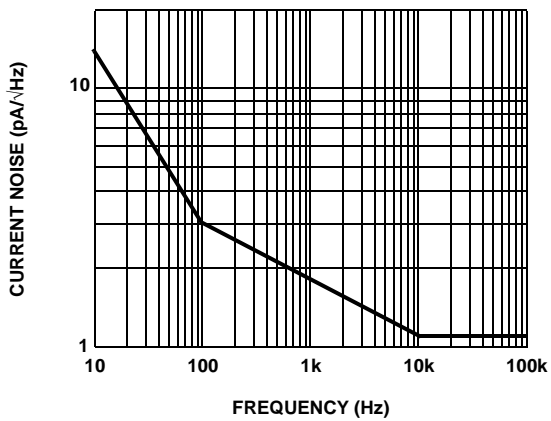

FIGURE 23. INPUT CURRENT NOISE

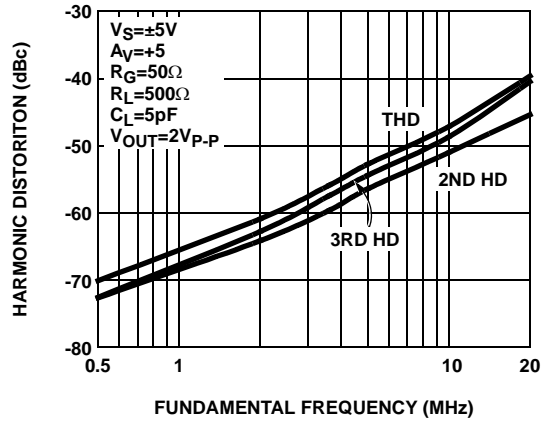

FIGURE 24. HARMONIC DISTORTION vs FREQUENCY ($A_V=+5$)

Typical Performance Curves

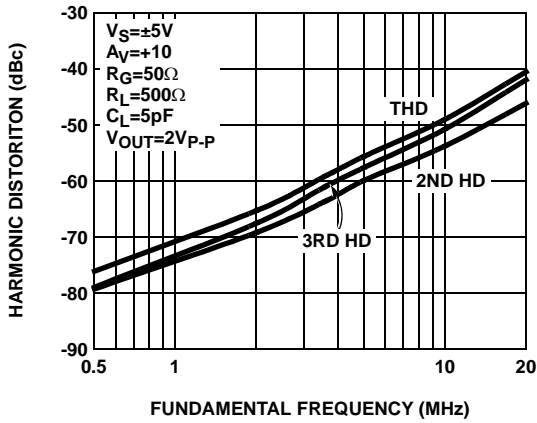

FIGURE 25. HARMONIC DISTORTION vs FREQUENCY ($A_V=+10$)

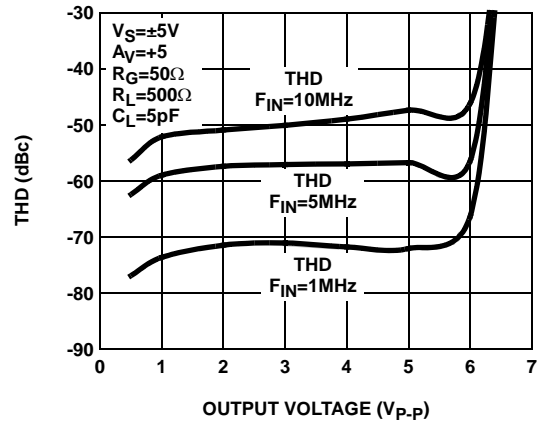

FIGURE 26. THD vs OUTPUT VOLTAGE (WORST HARMONIC)

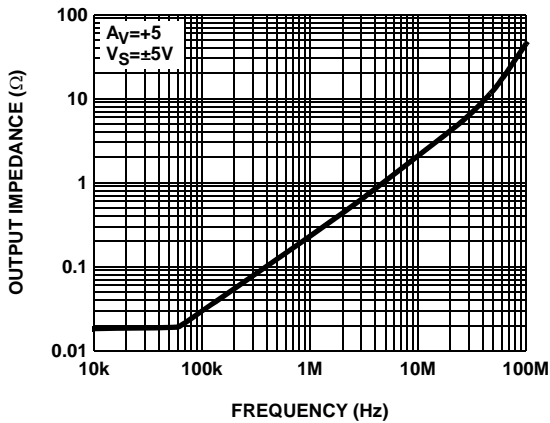

FIGURE 27. OUTPUT IMPEDANCE vs FREQUENCY

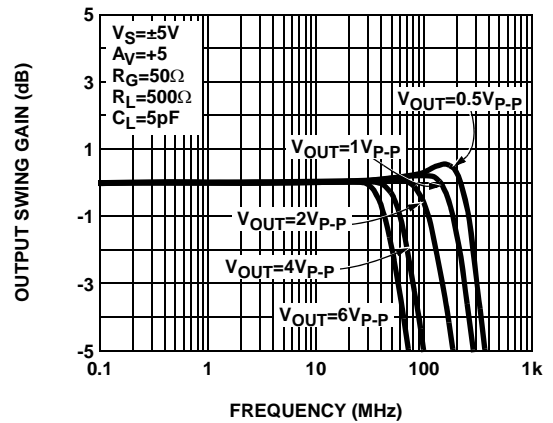

FIGURE 28. OUTPUT SWING vs FREQUENCY

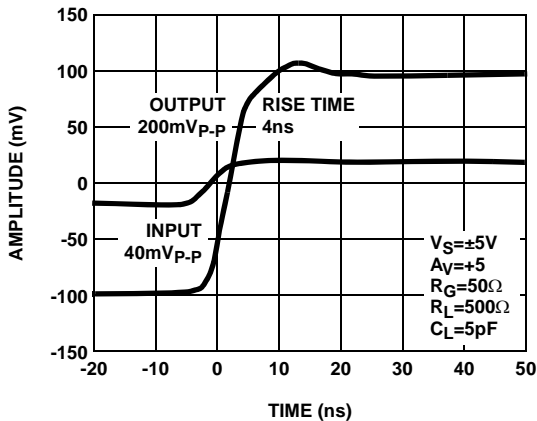

FIGURE 29. SMALL SIGNAL PULSE RESPONSE/RISE TIME

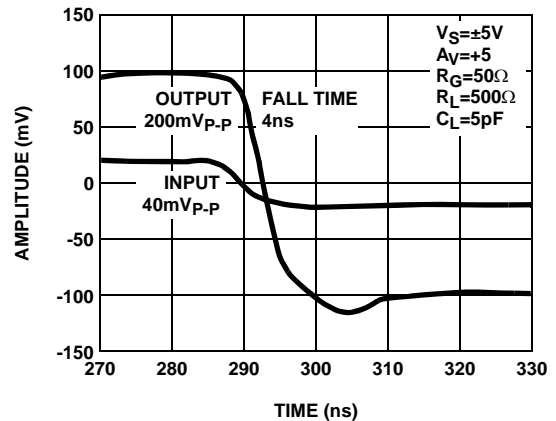

FIGURE 30. SMALL SIGNAL PULSE RESPONSE/FALL TIME

Typical Performance Curves

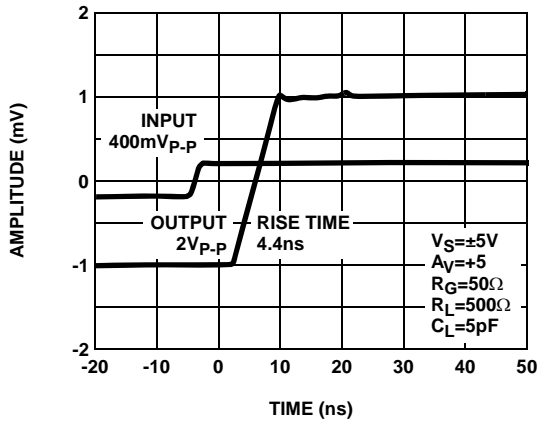

FIGURE 31. LARGE SIGNAL PULSE RESPONSE/RISE TIME

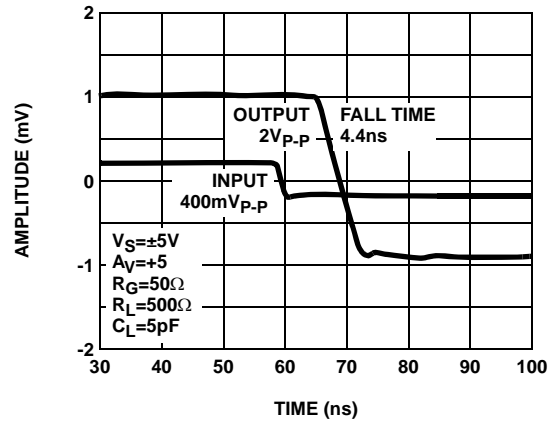

FIGURE 32. LARGE SIGNAL PULSE RESPONSE/RISE TIME

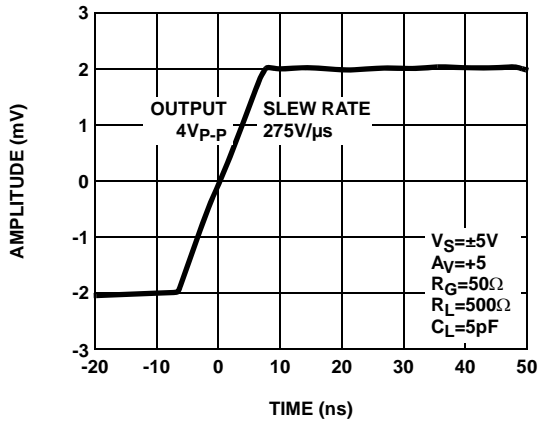

FIGURE 33. SLEW RATE (POSITIVE)

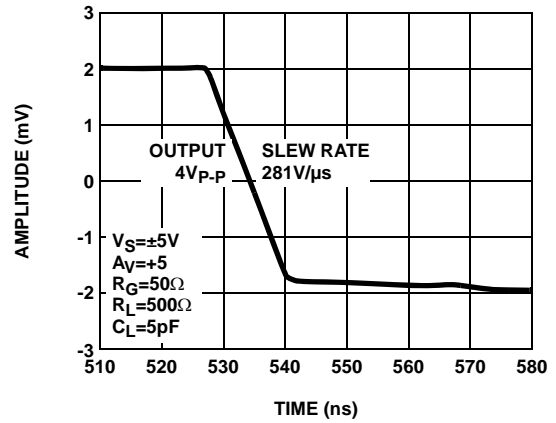

FIGURE 34. SLEW RATE (NEGATIVE)

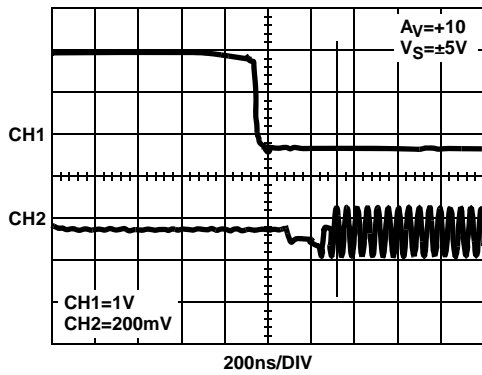

FIGURE 35. ENABLE RESPONSE/TURN-ON TIME

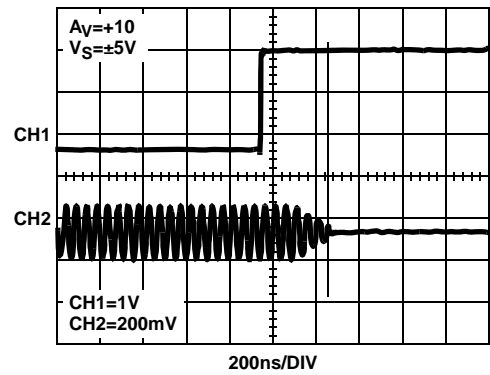

FIGURE 36. DISABLE RESPONSE/TURN-OFF TIME

Typical Performance Curves

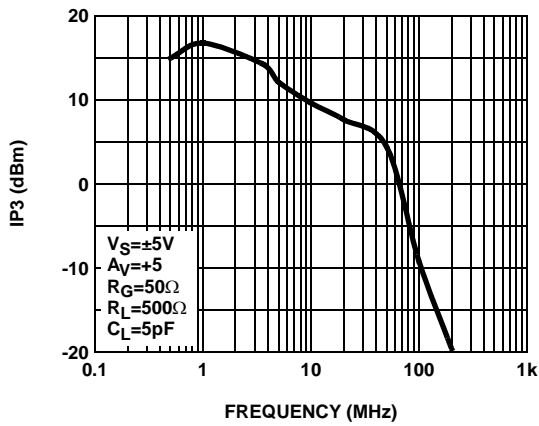

FIGURE 37. THIRD-ORDER INTERCEPT POINT

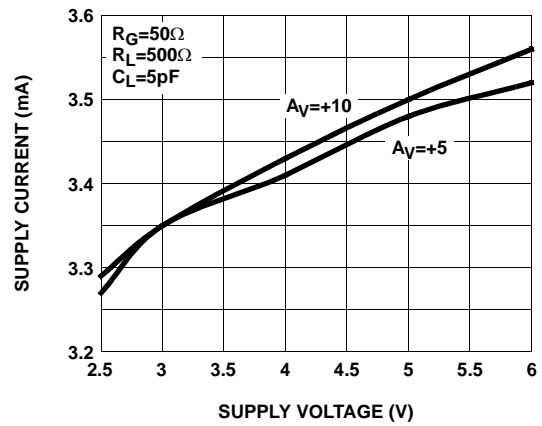

FIGURE 38. SUPPLY CURRENT vs SUPPLY VOLTAGE

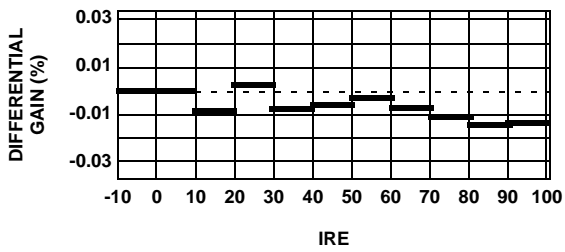

FIGURE 39. DIFFERENTIAL GAIN ERRORS

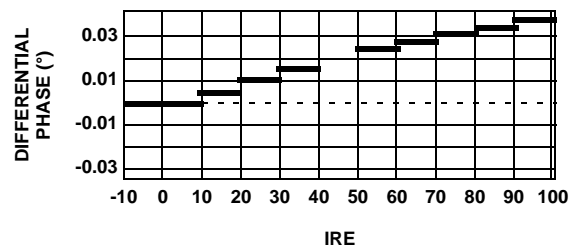

FIGURE 40. DIFFERENTIAL PHASE ERRORS

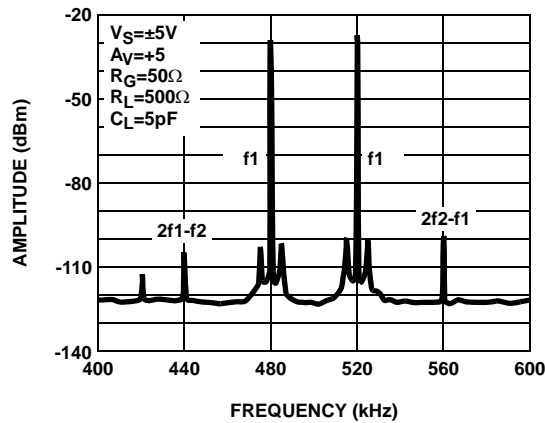

FIGURE 41. IP3

Typical Performance Curves

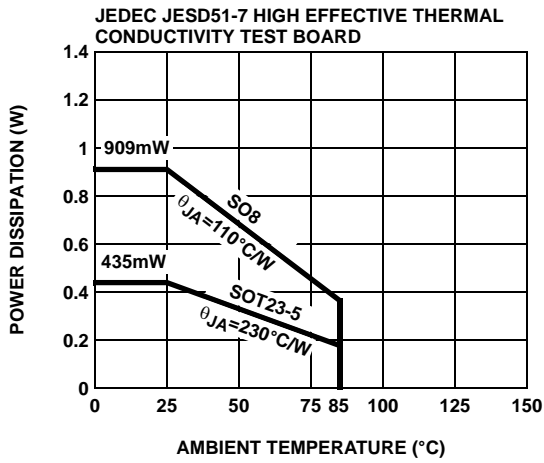

FIGURE 42. PACKAGE POWER DISSIPATION vs AMBIENT TEMPERATURE

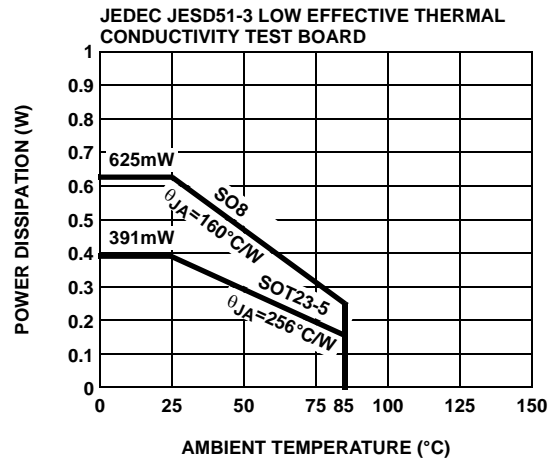
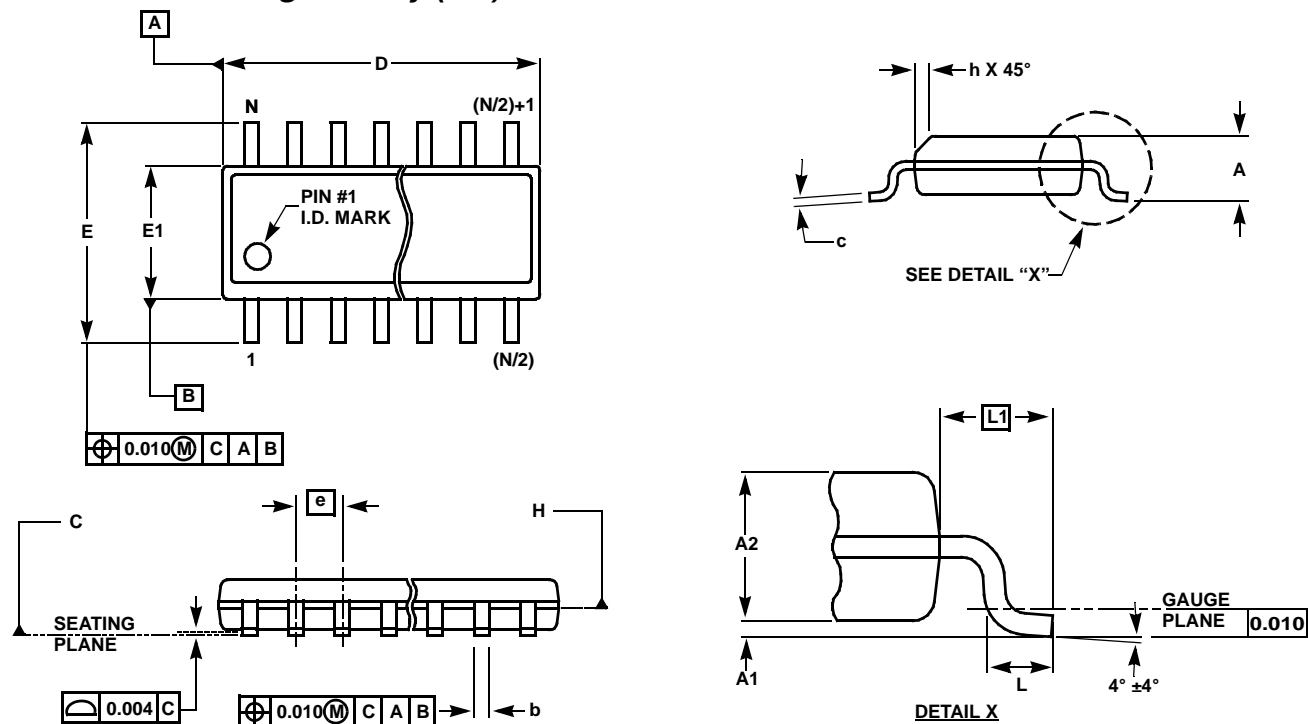

FIGURE 43. PACKAGE POWER DISSIPATION vs AMBIENT TEMPERATURE

Small Outline Package Family (SO)



MDP0027

SMALL OUTLINE PACKAGE FAMILY (SO)

SYMBOL	INCHES							TOLERANCE	NOTES
	SO-8	SO-14	SO16 (0.150")	SO16 (0.300") (SOL-16)	SO20 (SOL-20)	SO24 (SOL-24)	SO28 (SOL-28)		
A	0.068	0.068	0.068	0.104	0.104	0.104	0.104	MAX	-
A1	0.006	0.006	0.006	0.007	0.007	0.007	0.007	±0.003	-
A2	0.057	0.057	0.057	0.092	0.092	0.092	0.092	±0.002	-
b	0.017	0.017	0.017	0.017	0.017	0.017	0.017	±0.003	-
c	0.009	0.009	0.009	0.011	0.011	0.011	0.011	±0.001	-
D	0.193	0.341	0.390	0.406	0.504	0.606	0.704	±0.004	1, 3
E	0.236	0.236	0.236	0.406	0.406	0.406	0.406	±0.008	-
E1	0.154	0.154	0.154	0.295	0.295	0.295	0.295	±0.004	2, 3
e	0.050	0.050	0.050	0.050	0.050	0.050	0.050	Basic	-
L	0.025	0.025	0.025	0.030	0.030	0.030	0.030	±0.009	-
L1	0.041	0.041	0.041	0.056	0.056	0.056	0.056	Basic	-
h	0.013	0.013	0.013	0.020	0.020	0.020	0.020	Reference	-
N	8	14	16	16	20	24	28	Reference	-

Rev. M 2/07

NOTES:

1. Plastic or metal protrusions of 0.006" maximum per side are not included.
2. Plastic interlead protrusions of 0.010" maximum per side are not included.
3. Dimensions "D" and "E1" are measured at Datum Plane "H".
4. Dimensioning and tolerancing per ASME Y14.5M-1994

SOT-23 Package Family

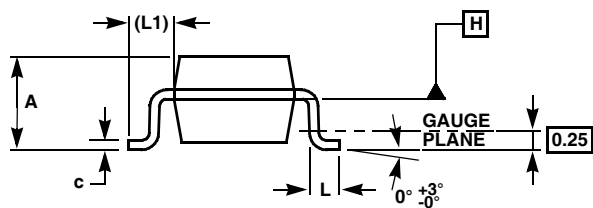
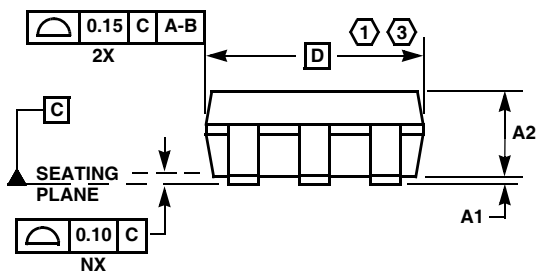
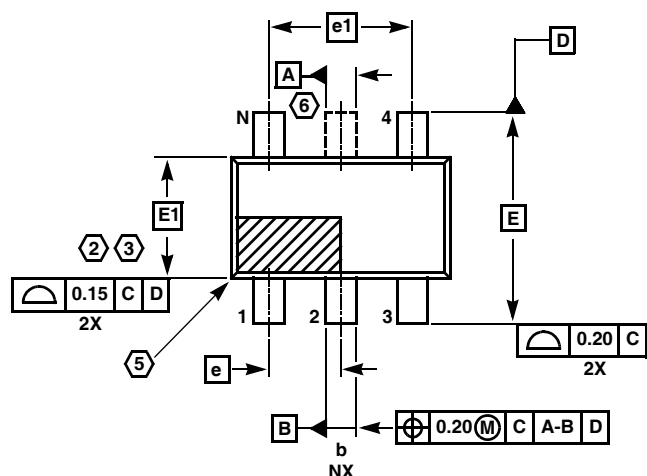

MDP0038

SOT-23 PACKAGE FAMILY

SYMBOL	MILLIMETERS		TOLERANCE
	SOT23-5	SOT23-6	
A	1.45	1.45	MAX
A1	0.10	0.10	±0.05
A2	1.14	1.14	±0.15
b	0.40	0.40	±0.05
c	0.14	0.14	±0.06
D	2.90	2.90	Basic
E	2.80	2.80	Basic
E1	1.60	1.60	Basic
e	0.95	0.95	Basic
e1	1.90	1.90	Basic
L	0.45	0.45	±0.10
L1	0.60	0.60	Reference
N	5	6	Reference

Rev. F 2/07

NOTES:

1. Plastic or metal protrusions of 0.25mm maximum per side are not included.
2. Plastic interlead protrusions of 0.25mm maximum per side are not included.
3. This dimension is measured at Datum Plane "H".
4. Dimensioning and tolerancing per ASME Y14.5M-1994.
5. Index area - Pin #1 I.D. will be located within the indicated zone (SOT23-6 only).
6. SOT23-5 version has no center lead (shown as a dashed line).

All Intersil U.S. products are manufactured, assembled and tested utilizing ISO9000 quality systems. Intersil Corporation's quality certifications can be viewed at www.intersil.com/design/quality

Intersil products are sold by description only. Intersil Corporation reserves the right to make changes in circuit design, software and/or specifications at any time without notice. Accordingly, the reader is cautioned to verify that data sheets are current before placing orders. Information furnished by Intersil is believed to be accurate and reliable. However, no responsibility is assumed by Intersil or its subsidiaries for its use; nor for any infringements of patents or other rights of third parties which may result from its use. No license is granted by implication or otherwise under any patent or patent rights of Intersil or its subsidiaries.

For information regarding Intersil Corporation and its products, see www.intersil.com