

Typical Applications

The HMC219MS8 / HMC219MS8E is ideal for:

- UNII & HiperLAN
- ISM
- Microwave Radios

Features

- Ultra Small Package: MSOP8
- Conversion Loss: 8.5 dB
- LO / RF Isolation: 25 dB

Functional Diagram

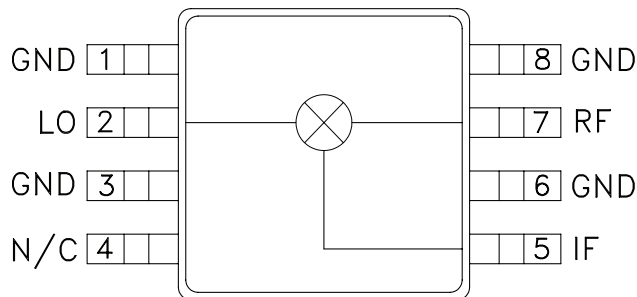

General Description

The HMC219MS8 & HMC219MS8E are ultra miniature double-balanced mixers in 8 lead plastic surface mount packages (MSOP). This passive MMIC mixer is constructed of GaAs Schottky diodes and novel planar transformer baluns on the chip. The device can be used as an upconverter, downconverter, bi-phase (de)modulator, or phase comparator. The consistent MMIC performance will improve system operation and assure regulatory compliance.

Electrical Specifications, $T_A = +25^\circ \text{C}$, As a Function of LO Drive

Parameter	LO = +13 dBm IF = 100 MHz			LO = +11 dBm IF = 100 MHz			Units
	Min.	Typ.	Max.	Min.	Typ.	Max.	
Frequency Range, RF & LO	4.5 - 9.0			4.5 - 8.6			GHz
Frequency Range, IF	DC - 2.5			DC - 2.5			GHz
Conversion Loss		8.5	10		8.5	10	dB
Noise Figure (SSB)		8.5	10		8.5	10	dB
LO to RF Isolation	17	25		20	25		dB
LO to IF Isolation	17	25		20	25		dB
IP3 (Input)	15	21		15	21		dBm
1 dB Gain Compression (Input)	7	10		5	8		dBm



GaAs MMIC SMT DOUBLE-BALANCED MIXER, 4.5 - 9 GHz

Conversion Loss vs Temperature @ LO = +13 dBm

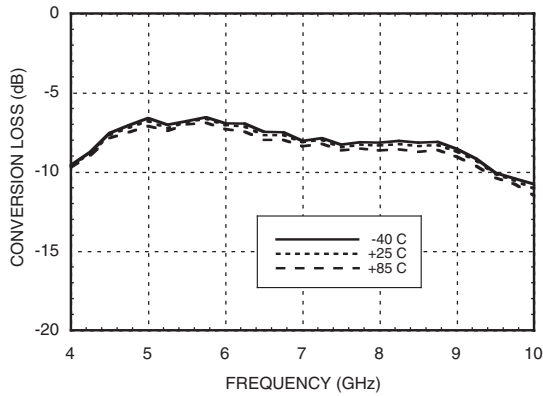

Isolation @ LO = +13 dBm

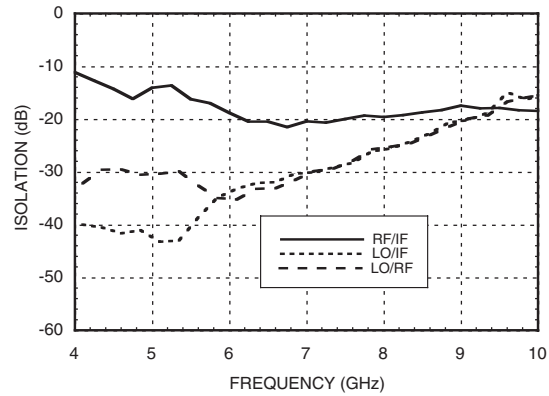

Conversion Loss vs. LO Drive

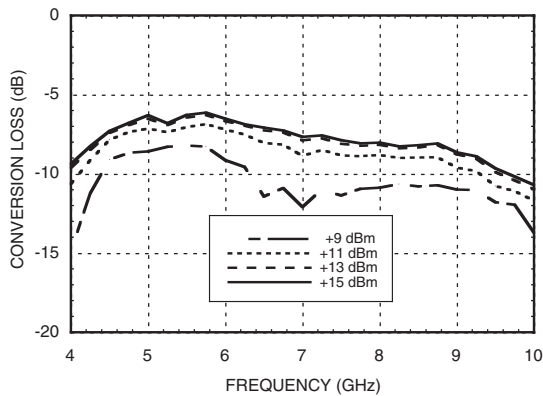

Return Loss @ LO = +13 dBm

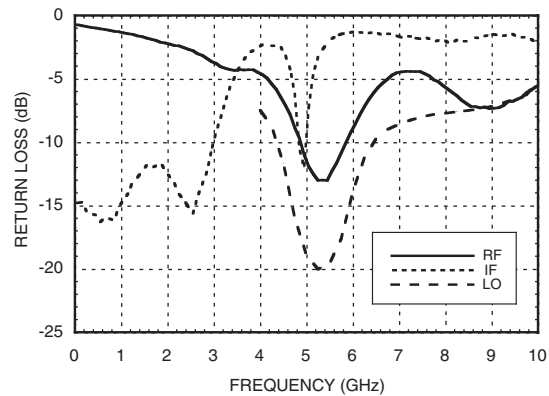

IF Bandwidth @ LO = +13 dBm

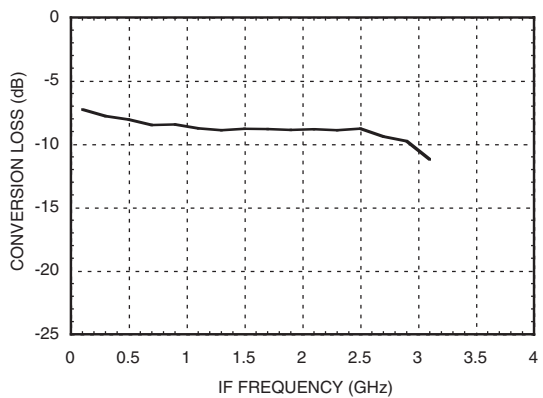

P1dB vs. Temperature LO = +13 dBm

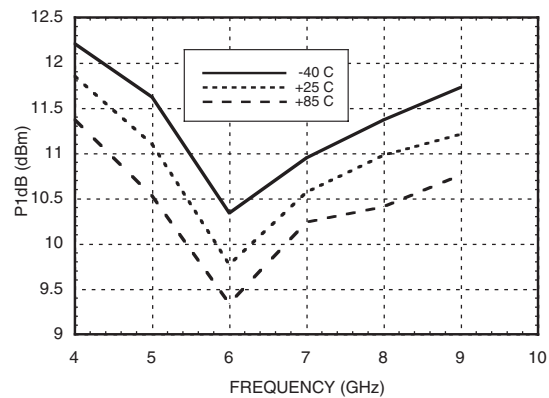



GaAs MMIC SMT DOUBLE-BALANCED MIXER, 4.5 - 9 GHz

Input IP3 vs. LO Drive

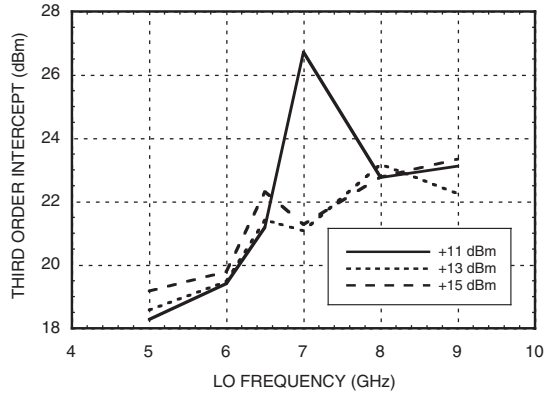

Input IP3 vs. Temperature @ LO = +13 dBm

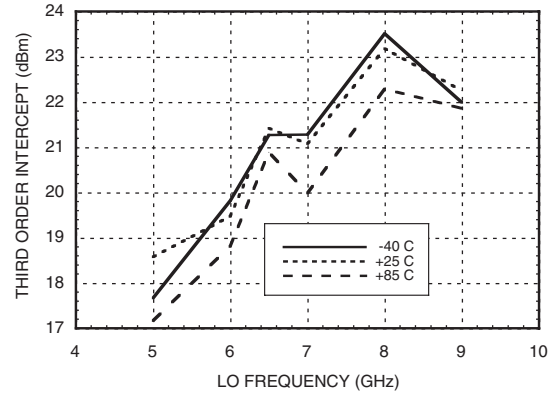

Input IP2 vs. Drive

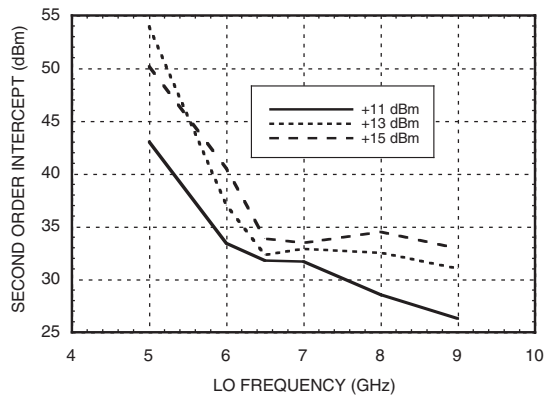

Input IP2 vs. Temperature @ LO = +13 dBm

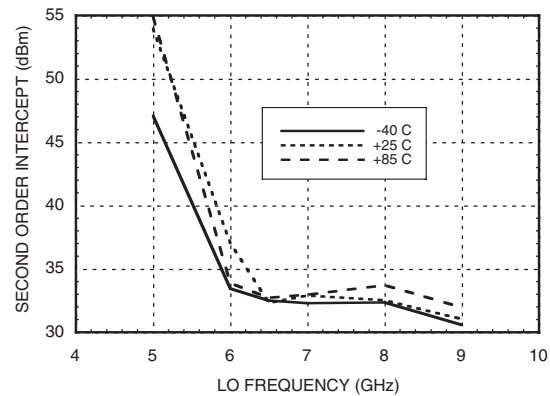

MxN Spurious Outputs

mRF	nLO				
	0	1	2	3	4
0	xx	12.2	22.3	20.7	33.9
1	13.2	0	36.9	36.7	49.5
2	79.8	53.7	47.7	55.4	68.1
3	>105	>105	78.1	65.5	83.1
4	>105	>105	>105	98.1	87.1

RF = 6 GHz @ -10 dBm
 LO = 6.1 GHz @ +13 dBm
 All values in dBc below the IF power level (-1RF + 1LO).

Harmonics of LO

LO Freq. (GHz)	nLO Spur at RF Port			
	1	2	3	4
4.0	33	29	39	54
5.0	31	23	34	47
6.0	35	21	40	55
7.0	31	26	53	xx
8.0	27	32	54	xx
9.0	21	43	xx	xx

LO = +13 dBm
 Values in dBc below input LO level measured at the RF port.

Absolute Maximum Ratings

RF / IF Input	+13 dBm
LO Drive	+27 dBm
Storage Temperature	-65 to +150 °C
Operating Temperature	-40 to +85 °C



ELECTROSTATIC SENSITIVE DEVICE
OBSERVE HANDLING PRECAUTIONS

Outline Drawing

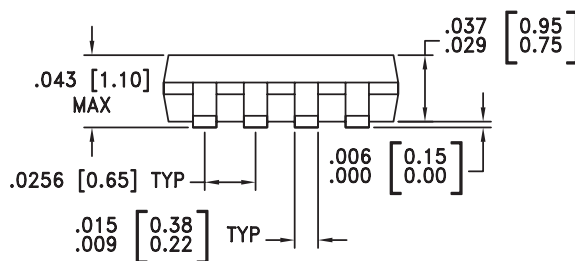
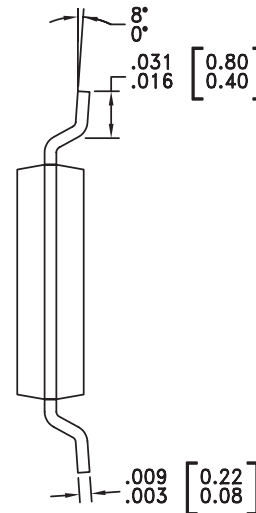
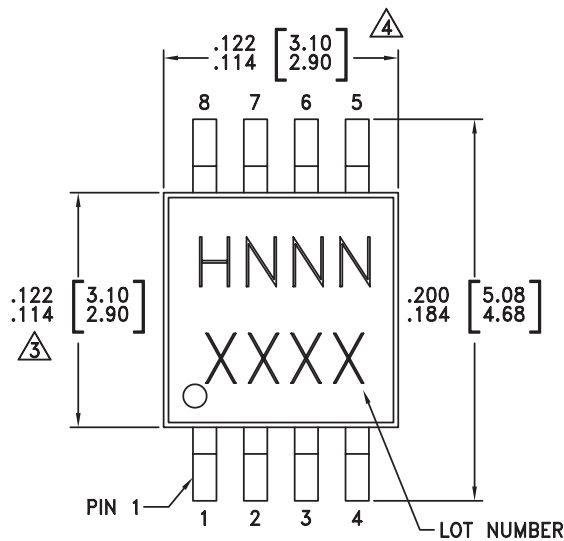

NOTES:

1. LEADFRAME MATERIAL: COPPER ALLOY
2. DIMENSIONS ARE IN INCHES [MILLIMETERS].
3. DIMENSION DOES NOT INCLUDE MOLDFLASH OF 0.15mm PER SIDE.
4. DIMENSION DOES NOT INCLUDE MOLDFLASH OF 0.25mm PER SIDE.
5. ALL GROUND LEADS MUST BE SOLDERED TO PCB RF GROUND.

Package Information

Part Number	Package Body Material	Lead Finish	MSL Rating	Package Marking ^[3]
HMC219MS8	Low Stress Injection Molded Plastic	Sn/Pb Solder	MSL1 ^[1]	H219 XXXX
HMC219MS8E	RoHS-compliant Low Stress Injection Molded Plastic	100% matte Sn	MSL1 ^[2]	H219 XXXX

[1] Max peak reflow temperature of 235 °C

[2] Max peak reflow temperature of 260 °C

[3] 4-Digit lot number XXXX

Evaluation Circuit Board

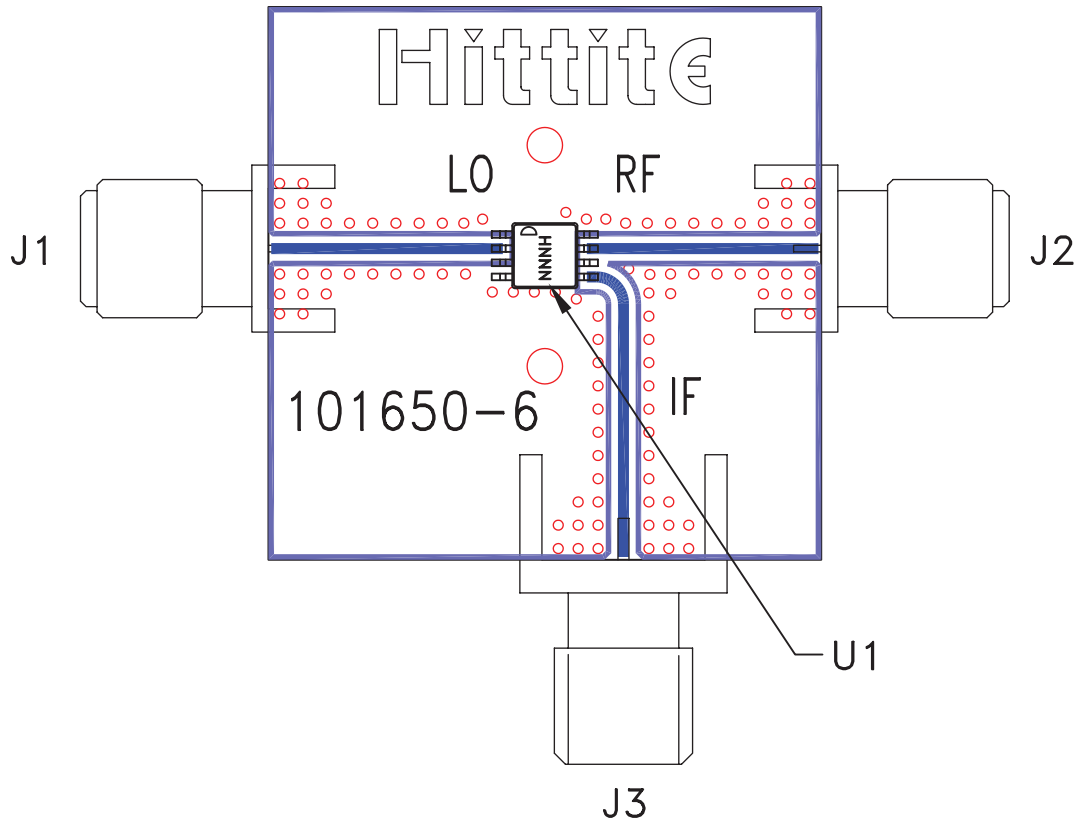

List of Materials for Evaluation PCB 103350 [1]

Item	Description
J1 - J3	PCB Mount SMA RF Connector
U1	HMC219MS8 / HMC219MS8E Mixer
PCB [2]	101650 Evaluation Board

[1] Reference this number when ordering complete evaluation PCB

[2] Circuit Board Material: Rogers 4350

The circuit board used in the final application should use RF circuit design techniques. Signal lines should have 50 ohm impedance while the package ground leads should be connected directly to the ground plane similar to that shown. A sufficient number of VIA holes should be used to connect the top and bottom ground planes. The evaluation circuit board shown is available from Hittite upon request.



Notes: