

Typical Applications

This amplifier is ideal for use as a driver amplifier for 5.0 - 6.0 GHz applications:

- UNII
- HiperLAN & 802.11a WLAN

Features

- Gain: 17 dB
- Saturated Power: +29 dBm
- 38% PAE
- Supply Voltage: +5.0 V
- Power Down Capability
- Low External Part Count

Functional Diagram

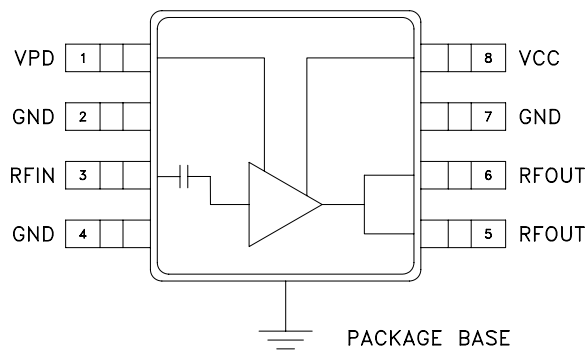

General Description

The HMC406MS8G & HMC406MS8GE are high efficiency GaAs InGaP Heterojunction Bipolar Transistor (HBT) MMIC Power amplifiers which operate between 5.0 and 6.0 GHz. The amplifier is packaged in a low cost, surface mount 8 leaded package with an exposed base for improved RF and thermal performance. With a minimum of external components, the amplifier provides 17 dB of gain and +29 dBm of saturated power at 38% PAE from a +5.0V supply voltage. Vpd can be used for full power down or RF output power/current control.

Electrical Specifications, $T_A = +25^\circ\text{C}$, $V_S = 5\text{V}$, $V_{pd} = 5\text{V}$

Parameter	Min.	Typ.	Max.	Min.	Typ.	Max.	Units
Frequency Range	5.0 - 6.0			5.7 - 5.9			GHz
Gain	13	16	21	14	17	21	dB
Gain Variation Over Temperature		0.03	0.04		0.03	0.04	dB/ °C
Input Return Loss		10			11		dB
Output Return Loss		8			9		dB
Output Power for 1 dB Compression (P1dB)	21	24		24	27		dBm
Saturated Output Power (Psat)		27			29		dBm
Output Third Order Intercept (IP3)	34	38		34	38		dBm
Noise Figure		6.0			6.0		dB
Supply Current (Icq)	Vpd = 0V/5V		0.002 / 300		0.002 / 300		mA
Control Current (Ipd)	Vpd = 5V		7		7		mA
Switching Speed	tON, tOFF		35		35		ns



Broadband Gain & Return Loss

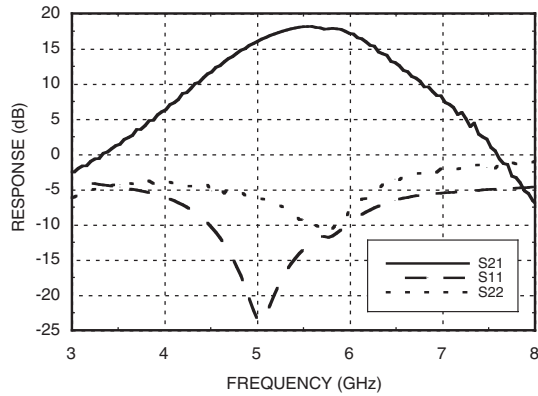

Gain vs. Temperature

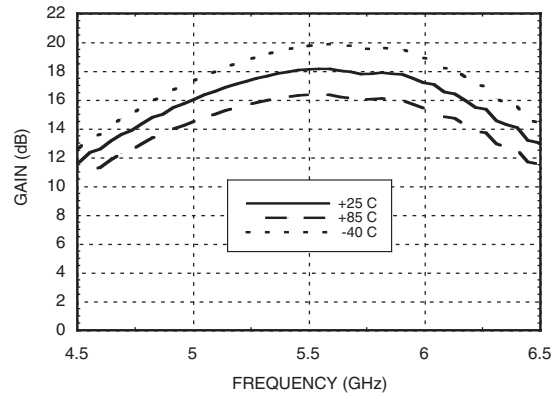

Input Return Loss vs. Temperature

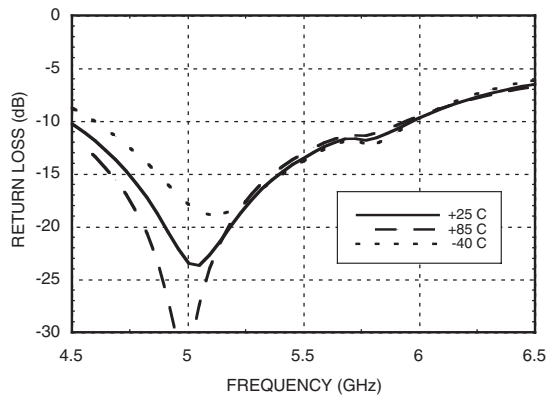

Output Return Loss vs. Temperature

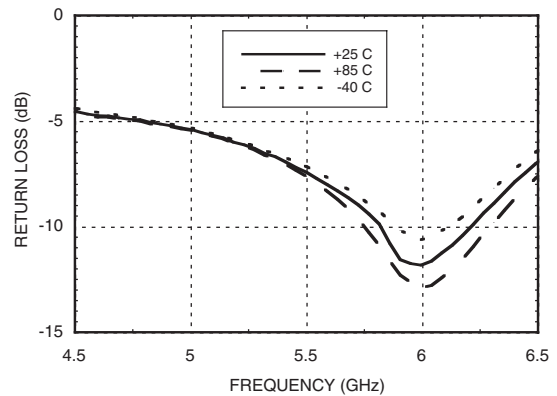

P1dB vs. Temperature

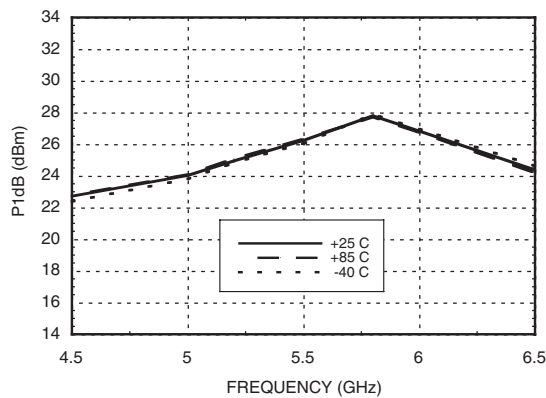

Psat vs. Temperature

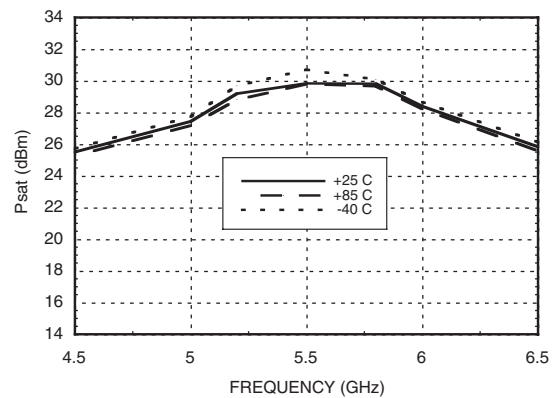

Power Compression @ 5.8 GHz

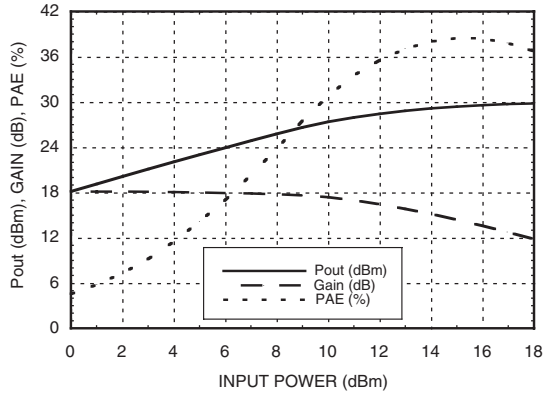

Output IP3 vs. Temperature

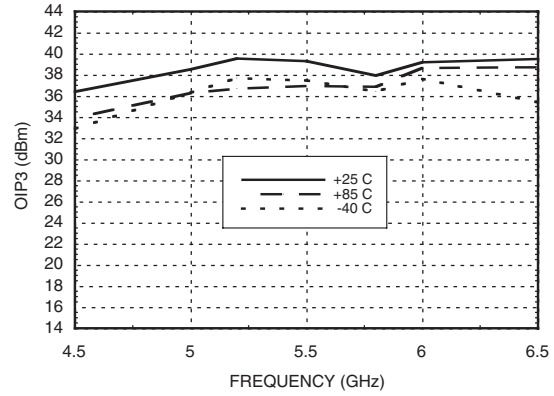

Noise Figure vs. Temperature

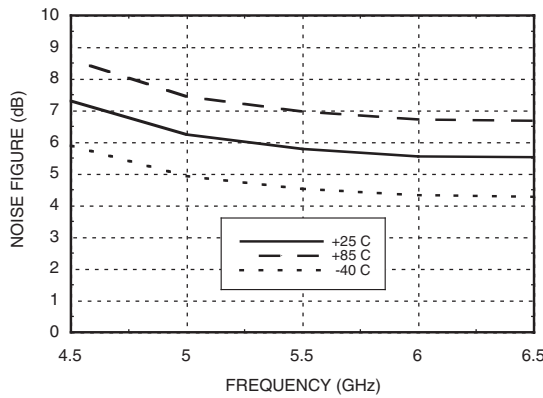

Gain & Power vs. Supply Voltage

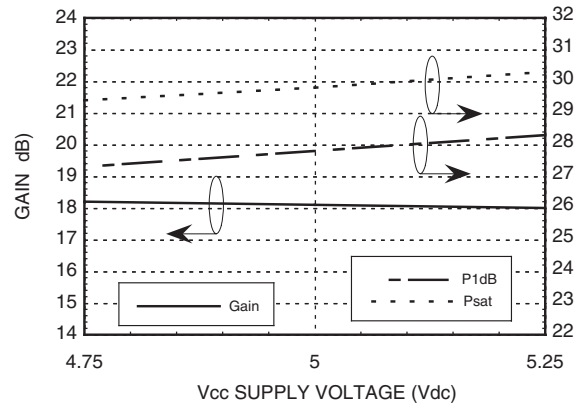

Reverse Isolation vs. Temperature

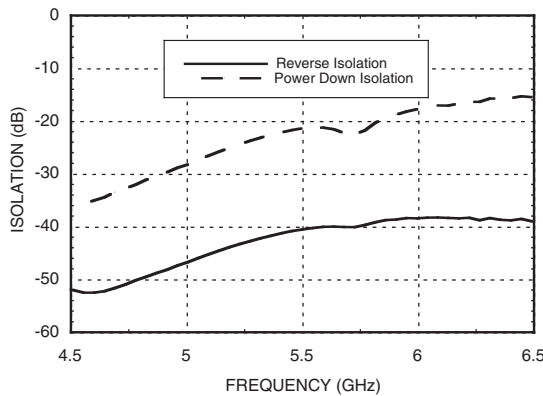

Gain, Power & Quiescent Supply Current vs. Vpd @ 5.8 GHz

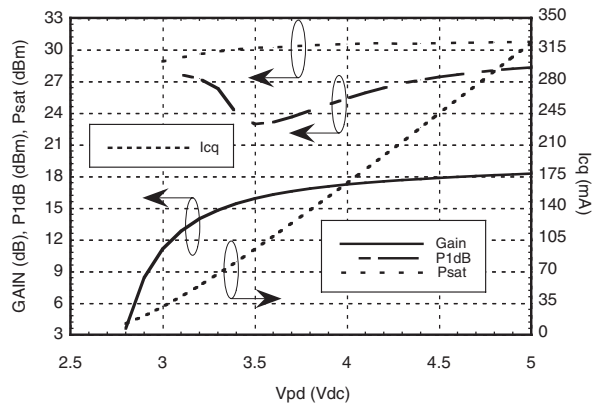

Absolute Maximum Ratings

Collector Bias Voltage (Vcc)	+5.5 Vdc
Control Voltage (Vpd)	+5.5 Vdc
RF Input Power (RFIn)(Vs = Vpd = +5.0 Vdc)	+20 dBm
Junction Temperature	150 °C
Continuous Pdiss (T = 85 °C) (derate 32 mW/°C above 85 °C)	2.1 W
Thermal Resistance (junction to ground paddle)	31 °C/W
Storage Temperature	-65 to +150 °C
Operating Temperature	-40 to +85° C



ELECTROSTATIC SENSITIVE DEVICE
OBSERVE HANDLING PRECAUTIONS

Outline Drawing

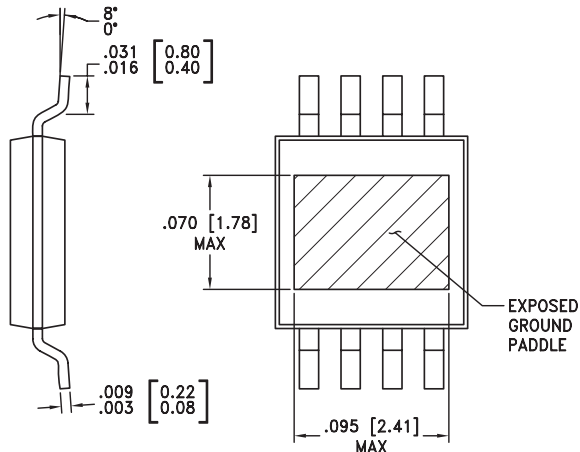
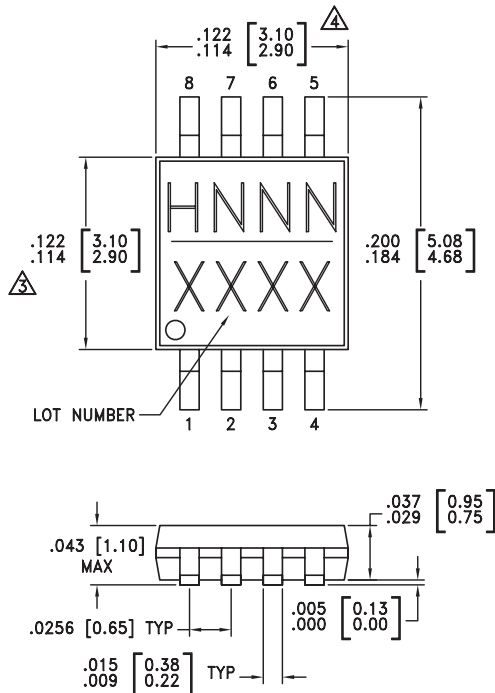

NOTES:

- LEADFRAME MATERIAL: COPPER ALLOY
- DIMENSIONS ARE IN INCHES [MILLIMETERS]
- \triangle DIMENSION DOES NOT INCLUDE MOLDFLASH OF 0.15mm PER SIDE.
- \triangle DIMENSION DOES NOT INCLUDE MOLDFLASH OF 0.25mm PER SIDE.
- ALL GROUND LEADS AND GROUND PADDLE MUST BE SOLDERED TO PCB RF GROUND.

Package Information



Part Number	Package Body Material	Lead Finish	MSL Rating	Package Marking ^[3]
HMC406MS8G	Low Stress Injection Molded Plastic	Sn/Pb Solder	MSL1 ^[1]	H406 XXXX
HMC406MS8GE	RoHS-compliant Low Stress Injection Molded Plastic	100% matte Sn	MSL1 ^[2]	H406 XXXX

[1] Max peak reflow temperature of 235 °C

[2] Max peak reflow temperature of 260 °C

[3] 4-Digit lot number XXXX

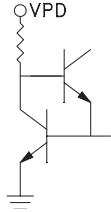
Pin Descriptions

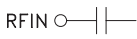
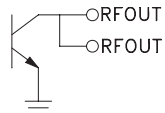
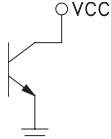
Pin Number	Function	Description	Interface Schematic
1	Vpd	Power Control Pin. For maximum power, this pin should be connected to 5.0V. A higher voltage is not recommended. For lower idle current, this voltage can be reduced.	
2, 4, 7	GND	Ground: Backside of package has exposed metal ground slug that must be connected to ground thru a short path. Vias under the device are required.	
3	RFIN	This pin is AC coupled and matched to 50 Ohms from 5.5 to 6.0 GHz.	
5, 6	RFOUT	RF output and bias for the output stage. The power supply for the output device needs to be supplied to these pins.	
8	Vcc	Power supply voltage for the first amplifier stage. An external bypass capacitor of 330 pF is required. This capacitor should be placed as close to the devices as possible.	

Evaluation PCB

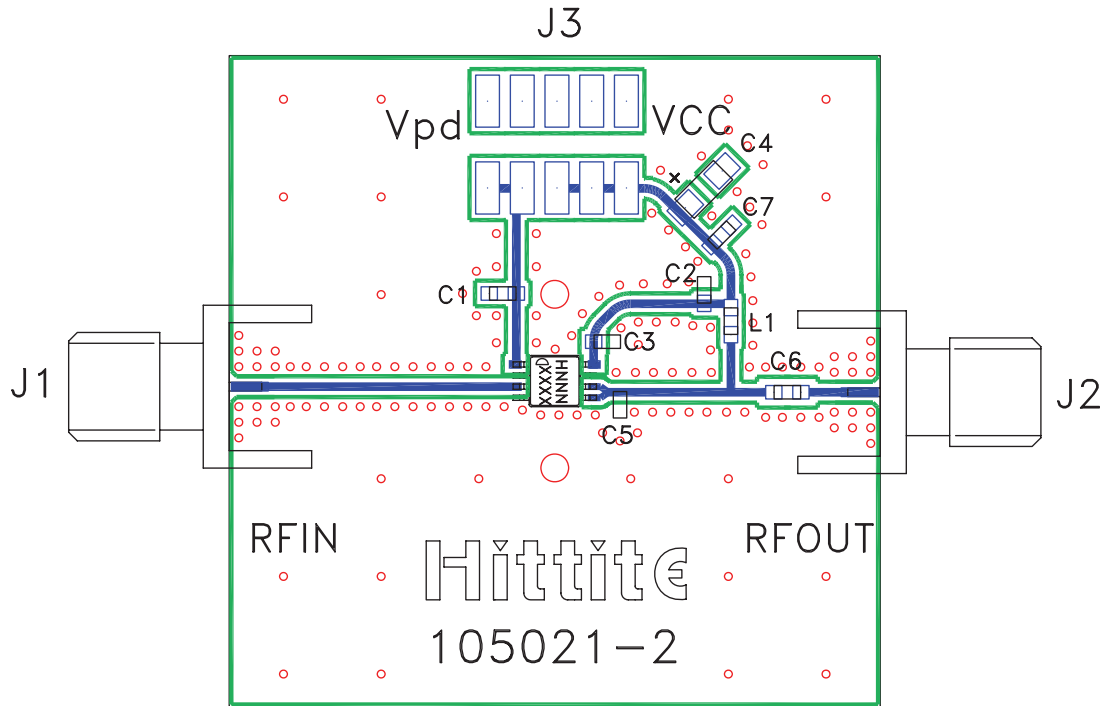

List of Materials for Evaluation PCB 104989 [1]

Item	Description
J1 - J2	PCB Mount SMA RF Connector
J3	2mm DC Header
C1 - C3	330 pF Capacitor, 0603 Pkg.
C4	2.2 μ F Capacitor, Tantalum
C5	0.6 pF Capacitor, 0603 Pkg.
C6	1.6 pF Capacitor, 0603 Pkg.
C7	100 pF Capacitor, 0603 Pkg.
L1	3.9 nH Inductor, 0603 Pkg.
U1	HMC406MS8G / HMC406MS8GE Amplifier
PCB [2]	105021 Eval Board

[1] Reference this number when ordering complete evaluation PCB

[2] Circuit Board Material: Roger 4350

The circuit board used in the final application should use RF circuit design techniques. Signal lines should have 50 ohm impedance while the package ground leads and exposed paddle should be connected directly to the ground plane similar to that shown. A sufficient number of via holes should be used to connect the top and bottom ground planes. The evaluation board should be mounted to an appropriate heat sink. The evaluation circuit board shown is available from Hittite upon request.

Application Circuit

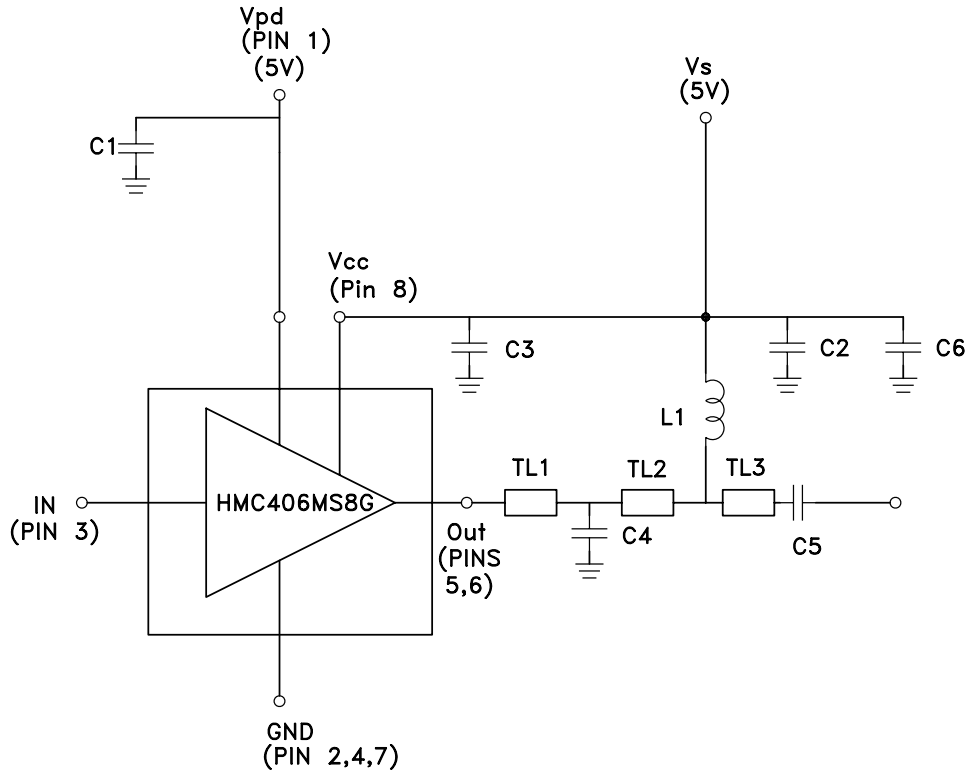

Note 1: C3 should be located < 0.020" from Pin 8 (Vcc)

Note 2: C2 should be located < 0.020" from L1.

	TL1	TL2	TL3
Impedance	50 Ohm	50 Ohm	50 Ohm
Length	0.038"	0.231"	0.1"



MICROWAVE CORPORATION v04.0307



HMC406MS8G / 406MS8GE

**GaAs InGaP HBT MMIC
POWER AMPLIFIER, 5.0 - 6.0 GHz**

Notes:

5

AMPLIFIERS - SMT