

### Typical Applications

Prescaler for DC to C Band PLL Applications:

- UNII, Point-to-Point & VSAT Radios
- 802.11a & HiperLAN WLAN
- Fiber Optic
- Cellular / 3G Infrastructure

### Features

- SSB Phase Noise: -153 dBc/Hz @100KHz
- Wide Bandwidth
- Output Power: -1 dBm
- Single DC Supply: +5V @ 69 mA
- MS8G SMT Package

### Functional Diagram

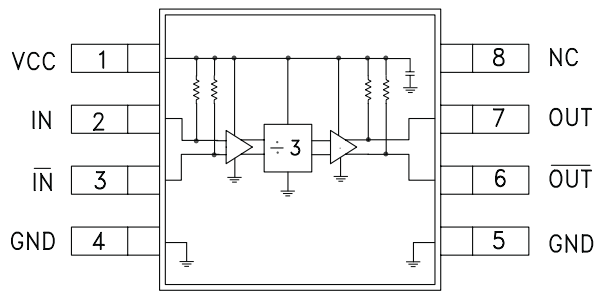

### General Description

The HMC437MS8G & HMC437MS8GE are low noise Divide-by-3 Static Dividers utilizing InGaP GaAs HBT technology in low cost 8 lead surface mount plastic packages. This device operates from DC (with a square wave input) to 7.0 GHz input frequency from a single +5.0V DC supply. The low additive SSB phase noise of -153 dBc/Hz at 100 kHz offset helps the user maintain good system noise performance.

### Electrical Specifications, $T_A = +25^\circ \text{C}$ , 50 Ohm System, $V_{CC} = 5V$

Parameter	Conditions	Min.	Typ.	Max.	Units
Maximum Input Frequency		7.0	7.5		GHz
Minimum Input Frequency	Sine Wave Input [1]		0.1		GHz
Input Power Range	$F_{in} = 1$ to 6 GHz	-12	-15	+12	dBm
	$F_{in} = 6$ to 7 GHz	-10	-15	+10	dBm
Output Power		-4	-1		dBm
Reverse Leakage	Both RF Outputs Terminated		-50		dBm
SSB Phase Noise (100 kHz offset)	$P_{in} = 0$ dBm, $F_{in} = 6$ GHz		-153		dBc/Hz
Output Transition Time	$P_{in} = 0$ dBm, $F_{out} = 882$ MHz		100		ps
Supply Current ( $I_{CC}$ )			69		mA

1. Divider will operate down to DC for square-wave input signal.



**Input Sensitivity Window,  $T = 25\text{ }^{\circ}\text{C}$**

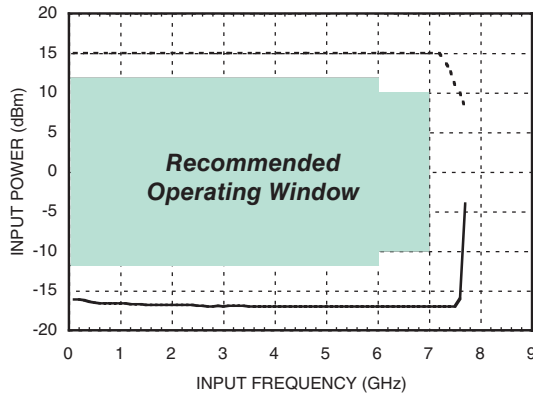

**Input Sensitivity Window vs. Temperature**

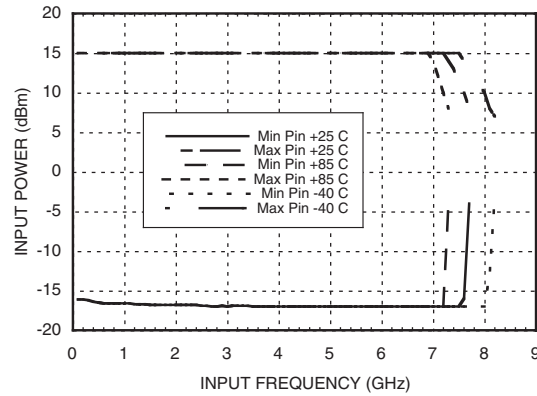

**Output Power vs. Temperature**

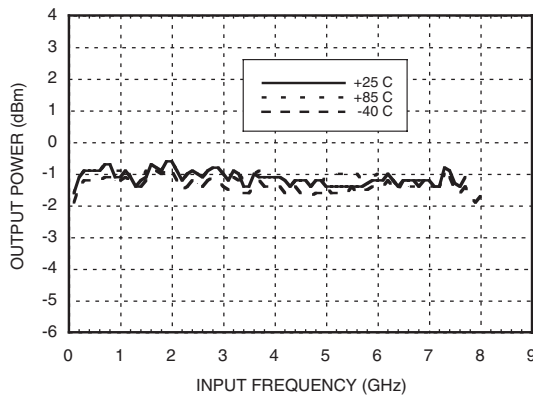

**SSB Phase Noise Performance,  $P_{in} = 0\text{ dBm}$ ,  $F_{in} = 6\text{ GHz}$ ,  $T = 25\text{ }^{\circ}\text{C}$**

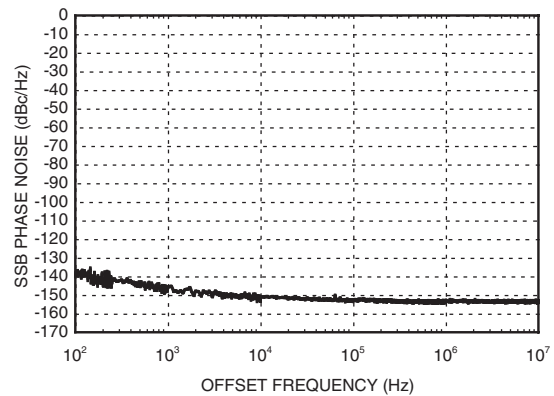

**Output Harmonic Content,  $P_{in} = 0\text{ dBm}$ ,  $T = 25\text{ }^{\circ}\text{C}$**

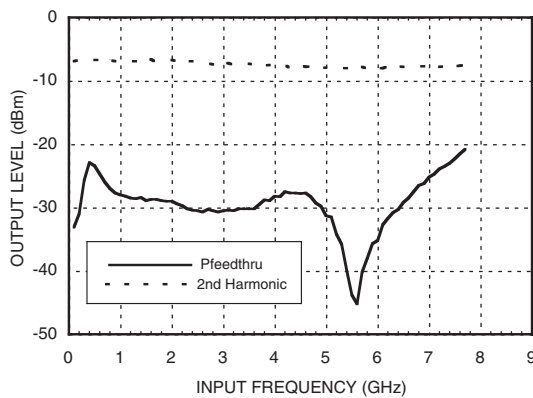

**Reverse Leakage,  $P_{in} = 0\text{ dBm}$ ,  $T = 25\text{ }^{\circ}\text{C}$**

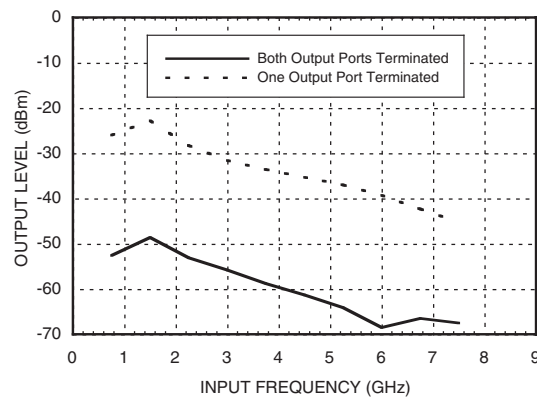

### Output Voltage Waveform, Pin= 0 dBm, Fout= 882 MHz, T= 25 °C

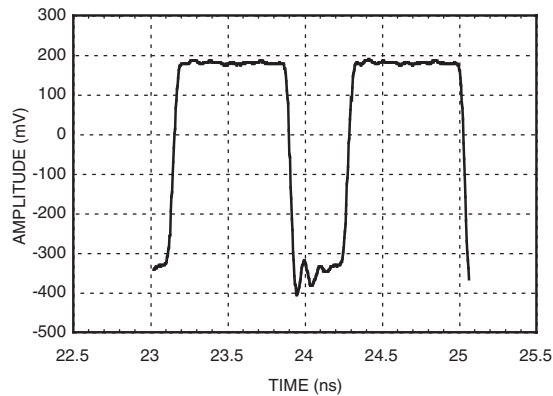

**ELECTROSTATIC SENSITIVE DEVICE  
OBSERVE HANDLING PRECAUTIONS**

### Outline Drawing

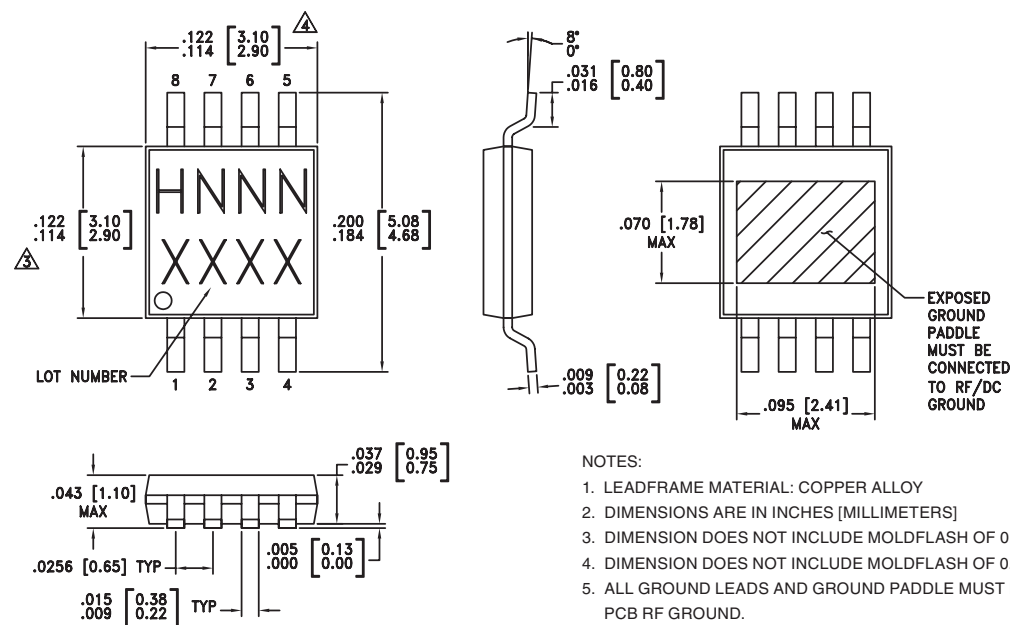

### Package Information

Part Number	Package Body Material	Lead Finish	MSL Rating	Package Marking <sup>[3]</sup>
HMC437MS8G	Low Stress Injection Molded Plastic	Sn/Pb Solder	MSL1 <sup>[1]</sup>	H437 XXXX
HMC437MS8GE	RoHS-compliant Low Stress Injection Molded Plastic	100% matte Sn	MSL1 <sup>[2]</sup>	<u>H437</u> XXXX

[1] Max peak reflow temperature of 235 °C

[2] Max peak reflow temperature of 260 °C

[3] 4-Digit lot number XXXX

### Absolute Maximum Ratings

RF Input (Vcc= +5V)	+13 dBm
Vcc	+5.5V
Maximum Channel Temperature	135 °C
Continuous Pdiss (T=85 °C) (derate 9.85mW/°C above 92 °C)	424mW
Storage Temperature	-65 to +150 °C
Operating Temperature	-40 to +85 °C

DC blocking capacitors are required at RF input and RF output ports. Choose value for lowest frequency of operation.



### Typical Supply Current vs. Vcc

Vcc (V)	Icc (mA)
4.75	64
5.0	69
5.25	75

Note: Divider will operate over full voltage range shown above

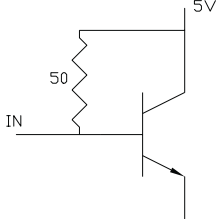
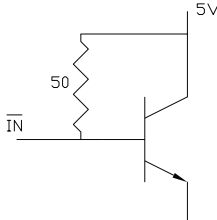

## Pin Description

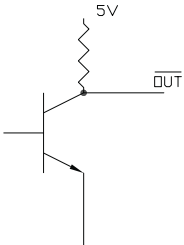
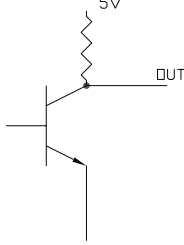
Pin Number	Function	Description	Interface Schematic
1	Vcc	Supply voltage 5V ± 0.25V.	
2	IN	RF input must be DC blocked.	
3	$\overline{\text{IN}}$	RF input 180° out of phase with pin 2 for differential operation. AC ground for single ended operation.	
4, 5	GND	All ground leads and ground paddle must be soldered to PCB RF/DC ground.	
6	$\overline{\text{OUT}}$	Divided output 180° out of phase with pin 7.	
7	OUT	Divided Output.	
8	N/C	No Connection	

## Evaluation PCB

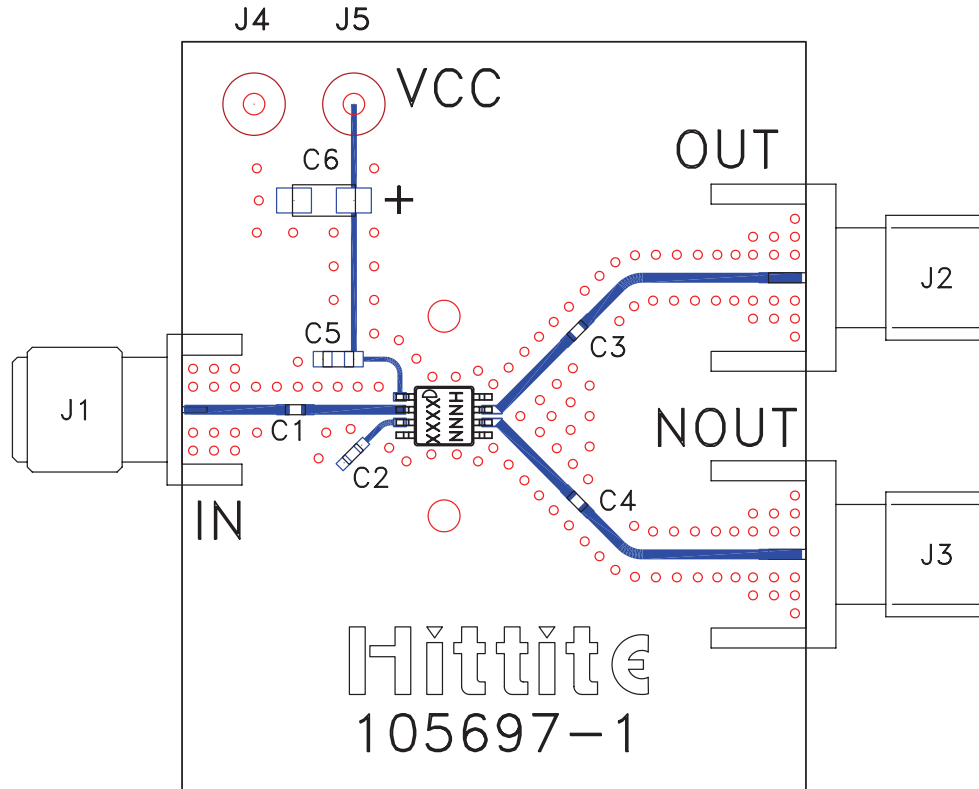

### List of Materials for Evaluation PCB 105786 [1]

Item	Description
J1 - J3	PCB Mount SMA RF Connector
J4, J5	DC Pin
C1 - C4	100 pF Capacitor, 0402 Pkg.
C5	10,000 pF Capacitor, 0603 Pkg.
C6	4.7 μF Tantalum Capacitor
U1	HMC437MS8G / HMC437MS8GE Divide-by-3
PCB [2]	105697 Eval Board

[1] Reference this number when ordering complete evaluation PCB

[2] Circuit Board Material: Rogers 4350

The circuit board used in the final application should use RF circuit design techniques. Signal lines should have 50 ohm impedance while the package ground leads and backside ground slug should be connected directly to the ground plane similar to that shown. A sufficient number of via holes should be used to connect the top and bottom ground planes. The evaluation circuit board shown is available from Hittite upon request. This evaluation board is designed for single ended input testing. J2 and J3 provide differential output signals.



### Application Circuit

