

IRLBL1304

HEXFET® Power MOSFET

- >1mm lower profile than D²Pak
- Same footprint as D²pak
- Logic Level Gate
- Surface mount
- Ultra Low On-Resistance
- Fully Avalanche Rated
- 50% greater current in typ. application condition vs. D²Pak

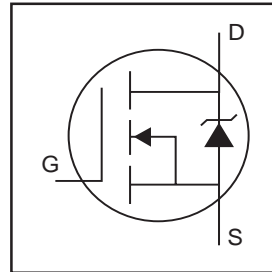

$V_{DS} = 40V$
$R_{DS(on)} = 0.0045\Omega$
$I_D = 185A^{⑤}$

Description

The HEXFET® MOSFET is the most popular power MOSFET in the world.

This particular HEXFET® MOSFET is in the SuperD²Pak™ and has the same outline and pinout as the standard D²Pak but has increased current handling capability and >1mm lower profile. This makes it ideal to reduce component count in multiparallel D²Pak operation, reduce system power dissipation or upgrade existing design.

This package has also been designed to meet automotive qualification standard Q101 and can be used with normal surface mouting equipment and has the same temperature profile and recommendations as the commonly used D²Pak.



Absolute Maximum Ratings

	Parameter	Max.	Units
$I_D @ T_C = 25^\circ C$	Continuous Drain Current, $V_{GS} @ 10V^{⑥}$	185, pkg limited to 95A*	A
$I_D @ T_C = 100^\circ C$	Continuous Drain Current, $V_{GS} @ 10V^{⑥}$	130, pkg limited to 95A*	
I_{DM}	Pulsed Drain Current ①⑥	740	
$P_D @ T_C = 25^\circ C$	Power Dissipation	300	W
	Linear Derating Factor	2.0	W/°C
V_{GS}	Gate-to-Source Voltage	± 16	V
E_{AS}	Single Pulse Avalanche Energy②⑥	1160	mJ
I_{AR}	Avalanche Current④	100	A
E_{AR}	Repetitive Avalanche Energy④	30	mJ
dv/dt	Peak Diode Recovery dv/dt ③⑥	5.0	V/ns
T_J	Operating Junction and	-55 to + 175	°C
T_{STG}	Storage Temperature Range		
	Soldering Temperature, for 10 seconds	260 (1.6mm from case)	

Thermal Resistance

	Parameter	Typ.	Max.	Units
$R_{\theta JC}$	Junction-to-Case	—	0.50	W
$R_{\theta JA}$	Junction-to-Ambient	—	40	

* Current capability in normal application, see Fig.9.

Electrical Characteristics @ T_J = 25°C (unless otherwise specified)

	Parameter	Min.	Typ.	Max.	Units	Conditions
V _{(BR)DSS}	Drain-to-Source Breakdown Voltage	40	—	—	V	V _{GS} = 0V, I _D = 250μA
ΔV _{(BR)DSS} /ΔT _J	Breakdown Voltage Temp. Coefficient	—	0.043	—	V/°C	Reference to 25°C, I _D = 1mA ^⑥
R _{DS(on)}	Static Drain-to-Source On-Resistance	—	—	0.0045	Ω	V _{GS} = 10V, I _D = 110A ^④
		—	—	0.0065		V _{GS} = 4.5V, I _D = 93 ^④
V _{GS(th)}	Gate Threshold Voltage	1.0	—	—	V	V _{DS} = V _{GS} , I _D = 250μA
g _{fs}	Forward Transconductance	120	—	—	S	V _{DS} = 25V, I _D = 110A ^⑥
I _{DSS}	Drain-to-Source Leakage Current	—	—	25	μA	V _{DS} = 40V, V _{GS} = 0V
		—	—	250		V _{DS} = 32V, V _{GS} = 0V, T _J = 150°C
I _{GSS}	Gate-to-Source Forward Leakage	—	—	100	nA	V _{GS} = 16V
	Gate-to-Source Reverse Leakage	—	—	-100		V _{GS} = -16V
Q _g	Total Gate Charge	—	—	140	nC	I _D = 110A
Q _{gs}	Gate-to-Source Charge	—	—	39		V _{DS} = 32V
Q _{gd}	Gate-to-Drain ("Miller") Charge	—	—	79		V _{GS} = 4.5V, See Fig. 6 and 13 ^{④⑥}
t _{d(on)}	Turn-On Delay Time	—	21	—		V _{DD} = 20V
t _r	Rise Time	—	350	—		I _D = 110A
t _{d(off)}	Turn-Off Delay Time	—	45	—		R _G = 0.9Ω
t _f	Fall Time	—	103	—		R _D = 0.18Ω, See Fig. 10 ^{④⑥}
L _D	Internal Drain Inductance	—	2.0	—	nH	Between lead, 6mm (0.25in.) from package and center of die contact
L _S	Internal Source Inductance	—	5.0	—		
C _{iss}	Input Capacitance	—	7660	—	pF	V _{GS} = 0V
C _{oss}	Output Capacitance	—	2150	—		V _{DS} = 25V
C _{rss}	Reverse Transfer Capacitance	—	460	—		f = 1.0MHz, See Fig. 5 ^⑥

Source-Drain Ratings and Characteristics

	Parameter	Min.	Typ.	Max.	Units	Conditions
I _S	Continuous Source Current (Body Diode)	—	—	185 ^⑤	A	MOSFET symbol showing the integral reverse p-n junction diode.
I _{SM}	Pulsed Source Current (Body Diode) ^①	—	—	740		
V _{SD}	Diode Forward Voltage	—	—	1.3	V	T _J = 25°C, I _S = 110A, V _{GS} = 0V ^④
t _{rr}	Reverse Recovery Time	—	100	150	ns	T _J = 25°C, I _F = 110A
Q _{rr}	Reverse Recovery Charge	—	250	380	nC	di/dt = 100A/μs ^{④⑥}
t _{on}	Forward Turn-On Time	Intrinsic turn-on time is negligible (turn-on is dominated by L _S +L _D)				

Notes:

- ① Repetitive rating; pulse width limited by max. junction temperature. (See fig. 11)
- ② Starting T_J = 25°C, L = 230μH
R_G = 25Ω, I_{AS} = 100A. (See Figure 12)
- ③ I_{SD} ≤ 110A, di/dt ≤ 170A/μs, V_{DD} ≤ V_{(BR)DSS},
T_J ≤ 175°C
- ④ Pulse width ≤ 300μs; duty cycle ≤ 2%.
- ⑤ Calculated continuous current based on maximum allowable junction temperature; for recommended current-handling of the package refer to Design Tip # 93-4.
- ⑥ Uses IRLBA1304/P data and test conditions.

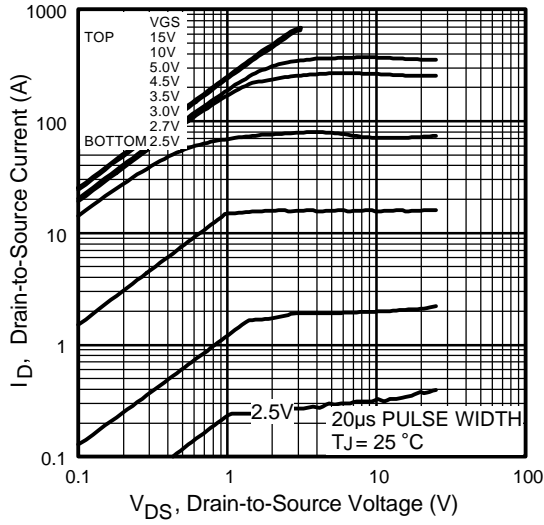

Fig 1. Typical Output Characteristics

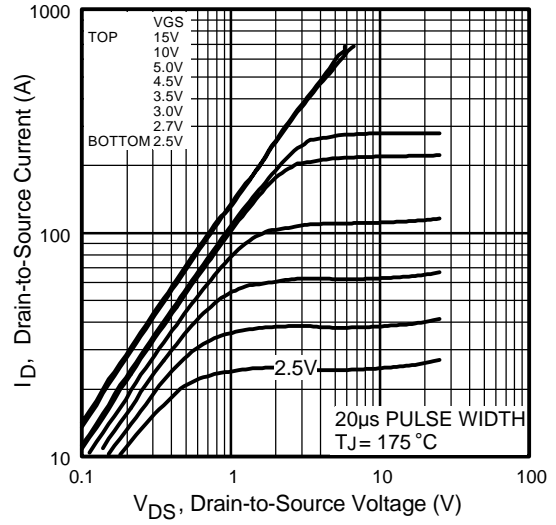

Fig 2. Typical Output Characteristics

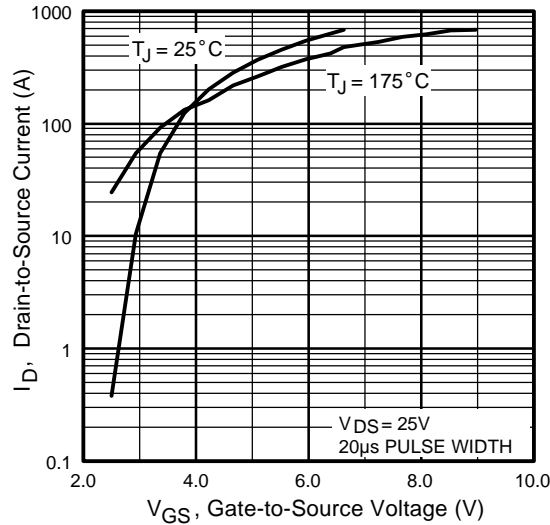

Fig 3. Typical Transfer Characteristics

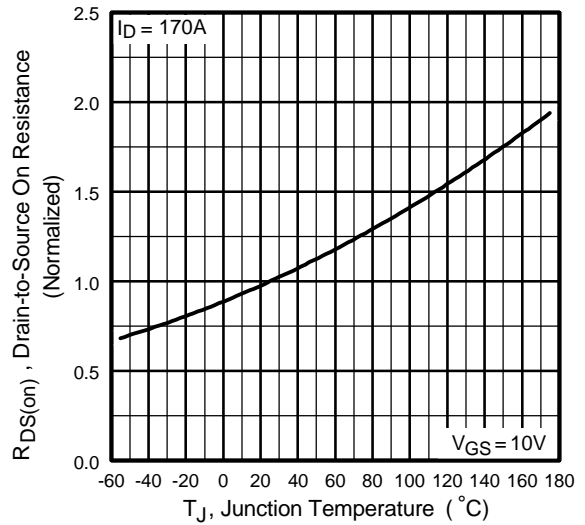

Fig 4. Normalized On-Resistance Vs. Temperature

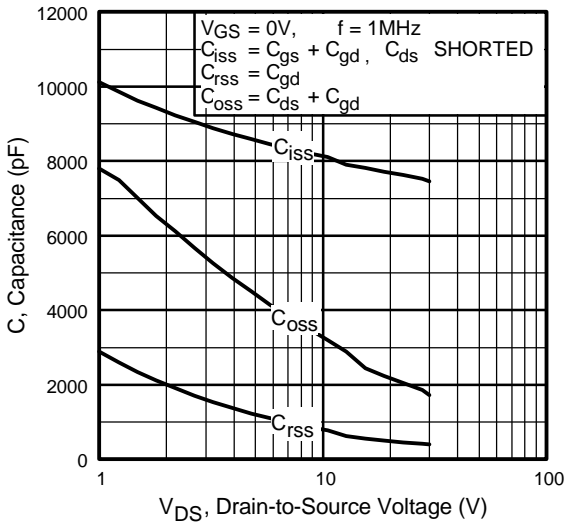

Fig 5. Typical Capacitance Vs. Drain-to-Source Voltage

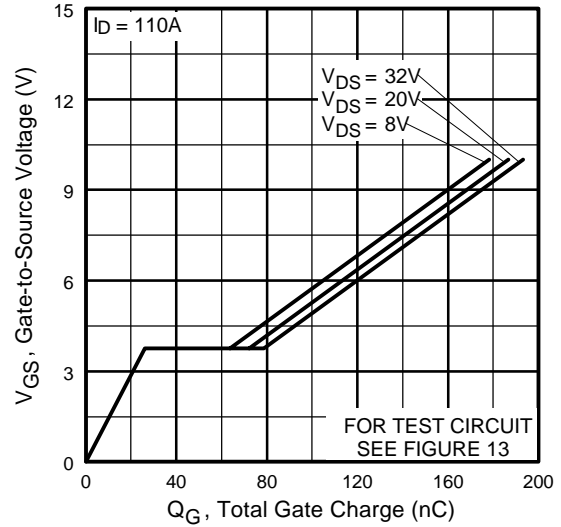

Fig 6. Typical Gate Charge Vs. Gate-to-Source Voltage

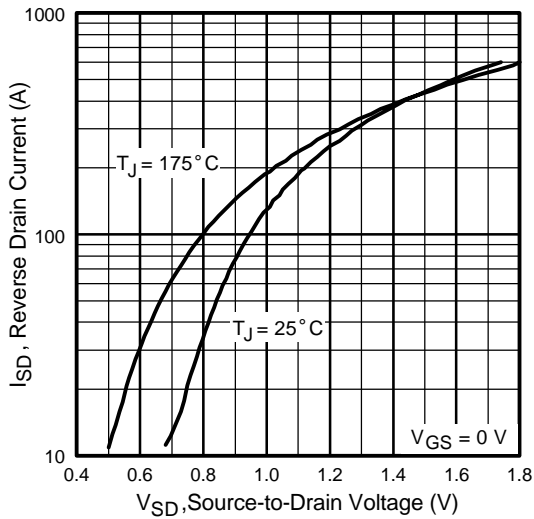

Fig 7. Typical Source-Drain Diode Forward Voltage

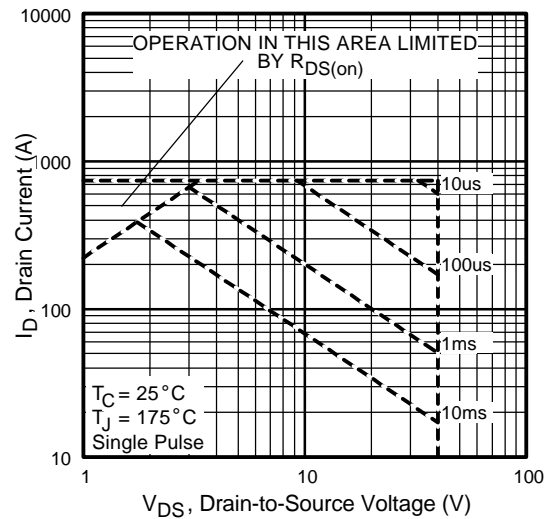

Fig 8. Maximum Safe Operating Area

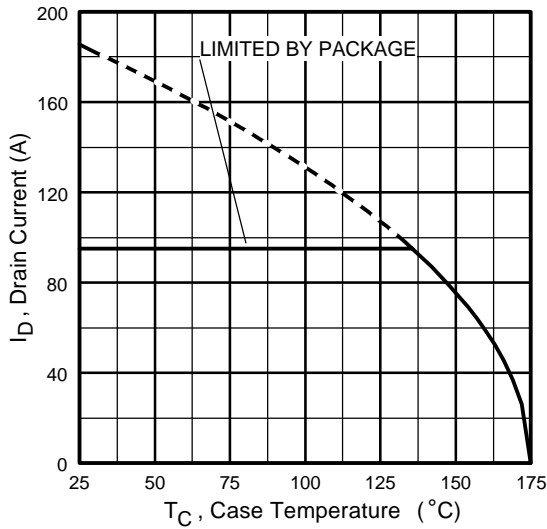

Fig 9. Maximum Drain Current Vs. Case Temperature

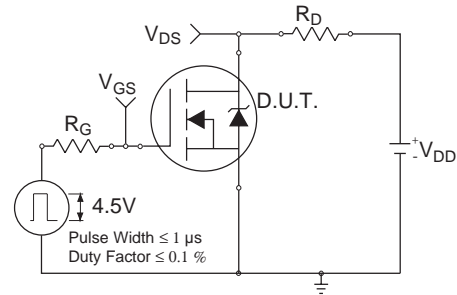

Fig 10a. Switching Time Test Circuit

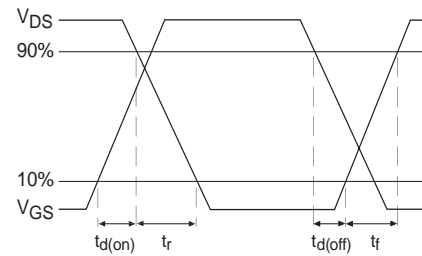

Fig 10b. Switching Time Waveforms

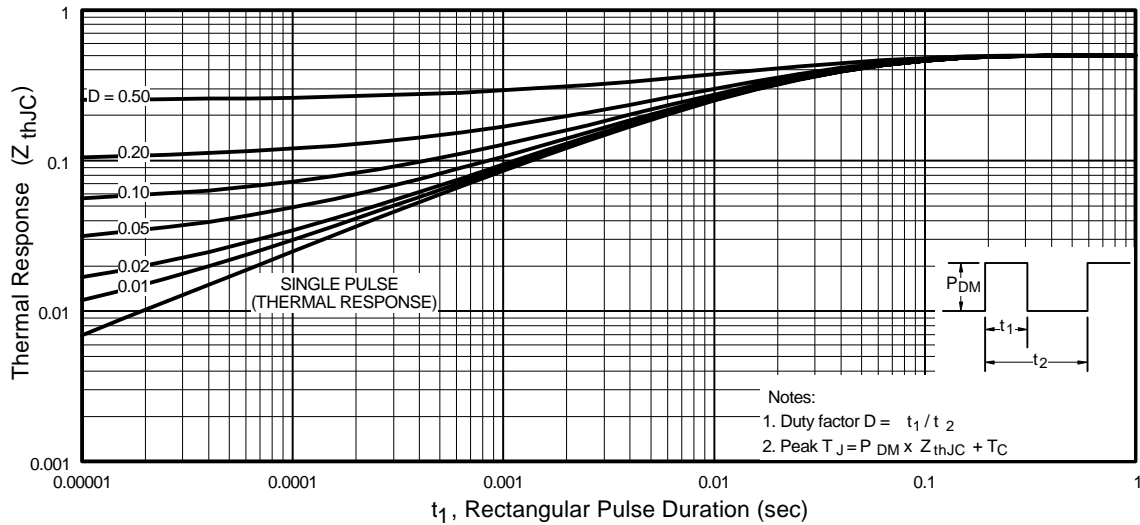

Fig 11. Maximum Effective Transient Thermal Impedance, Junction-to-Case

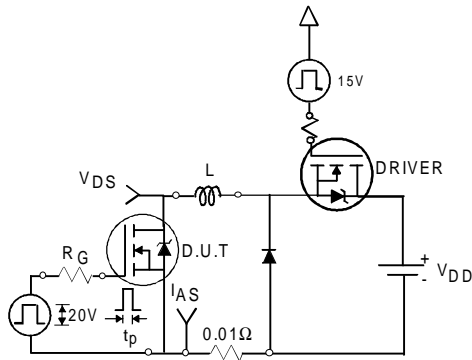

Fig 12a. Unclamped Inductive Test Circuit



Fig 12b. Unclamped Inductive Waveforms

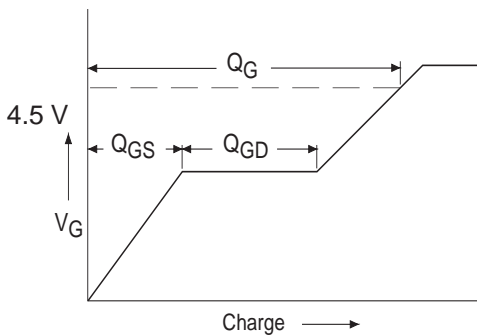

Fig 13a. Basic Gate Charge Waveform

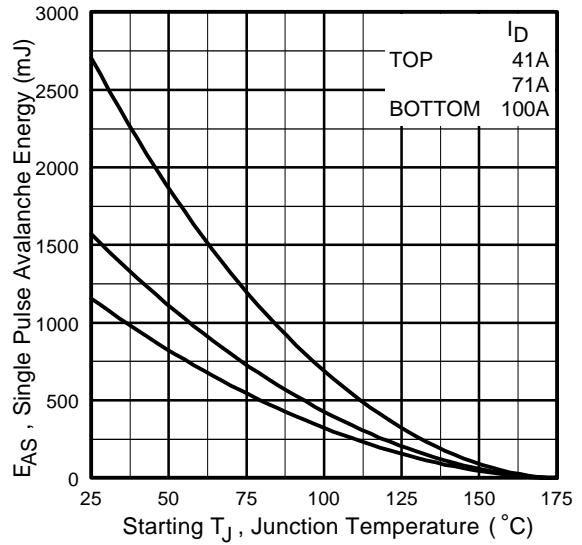

Fig 12c. Maximum Avalanche Energy Vs. Drain Current

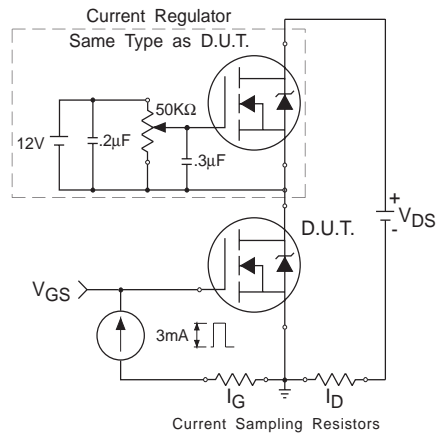

Fig 13b. Gate Charge Test Circuit

Peak Diode Recovery dv/dt Test Circuit



* $V_{GS} = 5V$ for Logic Level Devices

Fig 14. For N-Channel HEXFET® Power MOSFETs

IRLBL1304

International
IR Rectifier

Super-D²Pak™ Package Outline

Dimensions are shown in millimeters (inches)

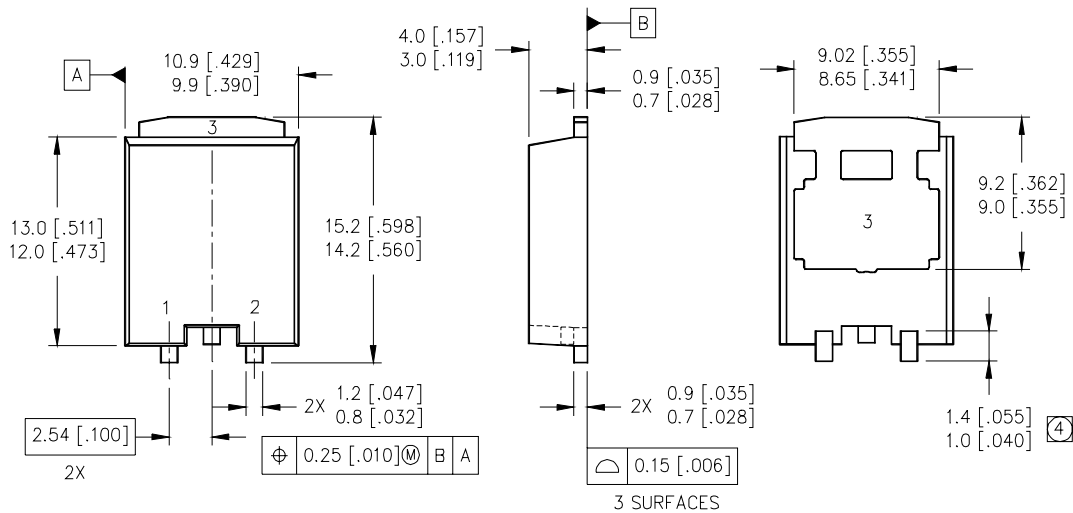

MINIMUM RECOMMENDED FOOTPRINT

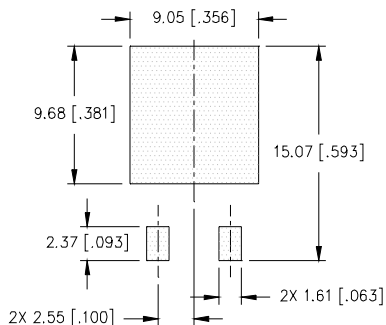

LEAD ASSIGNMENTS

MOSFET	SCHOTTKY / FRED
1 = GATE	1 = ANODE 1
2 = SOURCE	2 = ANODE 2
3 = DRAIN	3 = COMMON CATHODE

NOTES:

- DIMENSIONING & TOLERANCING PER ASME Y14.5M-1994.
- CONTROLLING DIMENSION: MILLIMETER.
- DIMENSIONS ARE SHOWN IN MILLIMETERS [INCHES].
- (4) DIMENSION IS MEASURED AT FULL LEAD WIDTH.

International
IR Rectifier

WORLD HEADQUARTERS: 233 Kansas St., El Segundo, California 90245, Tel: (310) 252-7105

IR GREAT BRITAIN: Hurst Green, Oxted, Surrey RH8 9BB, UK Tel: ++ 44 1883 732020

IR CANADA: 15 Lincoln Court, Brampton, Ontario L6T3Z2, Tel: (905) 453 2200

IR GERMANY: Saalburgstrasse 157, 61350 Bad Homburg Tel: ++ 49 6172 96590

IR ITALY: Via Liguria 49, 10071 Borgaro, Torino Tel: ++ 39 11 451 0111

IR JAPAN: K&H Bldg., 2F, 30-4 Nishi-Ikebukuro 3-Chome, Toshima-Ku, Tokyo Japan 171 Tel: 81 3 3983 0086

IR SOUTHEAST ASIA: 1 Kim Seng Promenade, Great World City West Tower, 13-11, Singapore 237994 Tel: ++ 65 838 4630

IR TAIWAN: 16 Fl. Suite D. 207, Sec. 2, Tun Haw South Road, Taipei, 10673, Taiwan Tel: 886-2-2377-9936

Data and specifications subject to change without notice. 2/00