

Features and Benefits

- Absolute Integrated Pressure sensor
- Less than $\pm 1\%$ error range overall
- Programmable through the connector (3 pins)
- Trimmable offset and sensitivity
- On-Chip Signal Conditioning
- Output proportional to the applied pressure
- Ratiometric output
- Rail-to-rail output
- Diagnostics of broken supply wires and broken sensor
- Output protected against short-circuits at both battery terminals
- Different pressure ranges available

Application Examples

- Water pressure
- Oil pressure
- Manifold Air Pressure

Ordering Information

Part No.	Temperature Suffix	Package Code	Option	Description
MLX90269	L (-40°C to 150°C)	UF (die on foil)	- 1	1.2 to 3 Bar Full Scale

1. Functional Diagram

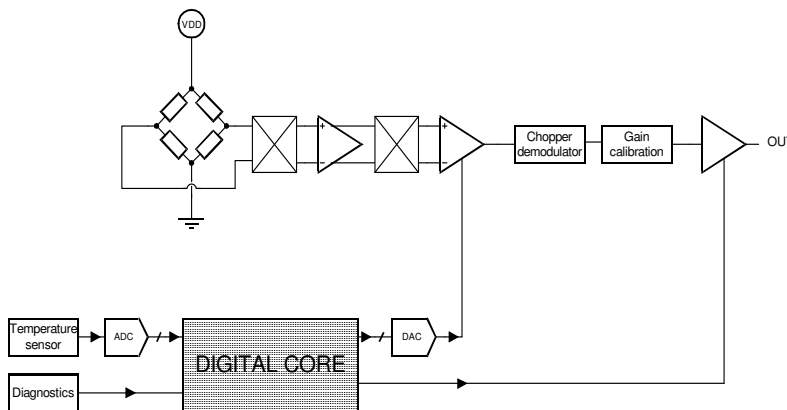

The output is proportional to the applied pressure with an adjustable slope and offset. It is ratiometric and goes rail-to-rail with a 3mA source and sink capability. Different pressure ranges are available (from 1.2 to 7 Bar full scale ranges, see above ordering information).

2. Description

The MLX90269 is an integrated absolute pressure sensor (0 Bar = vacuum) realized in CMOS technology with micromachining options. It consists of an analog signal chain that interacts with the digital core and on-chip temperature sensor in order to provide uniform overall sensing characteristics after calibration and to cancel the temperature related parameter drifts.

The output is proportional to the

TABLE OF CONTENTS

1. FUNCTIONAL DIAGRAM.....	1
2. DESCRIPTION.....	2
3. ABSOLUTE MAXIMUM RATINGS	3
4. MLX90269 ELECTRICAL SPECIFICATIONS	3
5. GENERAL DESCRIPTION	4
6. UNIQUE FEATURES.....	4
7. PERFORMANCE GRAPHS.....	5
8. APPLICATION INFORMATION	6
9. DIE DIMENSION AND PAD COORDINATES.....	7
10. CALIBRATION AND PROGRAMMING PROCEDURE	7
11. ESD PRECAUTIONS.....	8
12. DISCLAIMER.....	9

3. Absolute Maximum Ratings

Parameter	Min	Max
Supply Voltage, V_{DD}	-14V	16V
Output Voltage, V_{out}	-0.5V	16V
Storage Temperature Range, T_s	-55°C	165°C
ESD Sensitivity (AEC Q100 002)	-2 kV	2 kV

Exceeding the absolute maximum ratings may cause permanent damage. Exposure to absolute-maximum-rated conditions for extended periods may affect device reliability.

4. MLX90269 Electrical Specifications

DC Operating Parameters $T_A = -40^{\circ}\text{C}$ to 150°C , $V_{DD} = 5\text{V}$ (unless otherwise specified)

Parameter	Symbol	Test Conditions	Min	Typ	Max	Units
-----------	--------	-----------------	-----	-----	-----	-------

OPERATIONAL FEATURES						
Supply Voltage	V_{DD}	Operating	4.5	5	5.5	V
Supply Current	I_{DD}	$V_{DD} = 5\text{V} \pm 10\%$, excluding output current	4	6	10	mA
Output Current Capability	I_{out}	$V_{DD} = 5\text{V}$	-3		3	mA
Pressure output @ zero pressure	V_{out}	$V_{DD} = 5\text{V}$	0.46	0.5	0.54	V
Pressure output @ full scale pressure	V_{out}	$V_{DD} = 5\text{V}$	4.46	4.5	4.54	V
Low Clamping Level	V_{out}		5		10	% V_{DD}
High Clamping Level	V_{out}		90		95	% V_{DD}
DIAGNOSTIC FEATURES						
Output when sensor is broken		Sensor broken			2	% V_{DD}
Output when V_{DD} is broken		Pull-Up > 4.7K			5	% V_{DD}
Output when V_{SS} is broken		Pull-Down > 10K	95			% V_{DD}
Response Time (to reach 1% error)					2	ms

5. General Description

This chip integrates a pressure sensor and the associated signal conditioning on the same die. The supply voltage V_{DD} directly supplies the pressure sensor.

A chopped instrumentation stage amplifies the differential output signal of the sensor. The gain of this amplifier can be adjusted with 3 bits. The input stage is followed by a differential to single-ended conversion. The reference voltage for this stage is generated by a 10 bit DAC and varies linearly with temperature in order to perform the offset and offset drift compensation. A digital hardware multiplier calculates this compensation. The temperature signal, serving as input for this multiplier, is generated from the ADC of the output signal of the internal temperature sensor.

The chopped signal is demodulated with a switched capacitor stage. The buffered output serves as reference for a 10 bit DAC to perform the span and span drift compensation. The DAC is controlled by the digital part.

Finally the signal is given out by a class AB rail-to-rail amplifier capable of sourcing and sinking large currents.

A 3-point temperature and 2-point pressure calibration is required (room temperature, a low temperature and a high temperature), to achieve an error less than $\pm 1\%$ over the complete pressure and temperature range (the output error is referred to the output span).

PTC (Programming Through Connector) protocol is used to perform calibration.

6. Unique Features

Diagnostic Limits

Diagnostic of broken sensor: The output will be forced to ground (or a very low level) when the sensor membrane breaks.

Diagnostic of broken wires: The output will be forced to ground (or a very low level) when the supply wire breaks, even when a pull-up is still connected to the output pin.

The output will be forced to the supply voltage (or a very high level) when the ground wire breaks, even when a pull-down is still connected to the output pin.

Output Protection

The output is protected against short-circuits at either battery terminals. The output can handle voltages between -0.5V and 16V (independent of supply voltage).

Memlock Function

The memory consists of ZAP cells. When all calibration parameters are programmed, the chip can be locked. This to avoid unwanted data to be written into the memory cells. Once the chip is locked in a normal application, it is not possible to unlock.

Clamping Levels

The user can enable the clamping of the output to ensure that the output can not enter the fault band in normal application.

7. Performance Graphs

The graphs below show measured output voltages (on a 4 Bar full scale sensor) taken at 15 pressure points (500 mBar to 4000 mBar), at 21 ambient temperature points (-50 to 150 Celsius) and with Vdd set to 4.5 V, 5 V and 5.5 V.

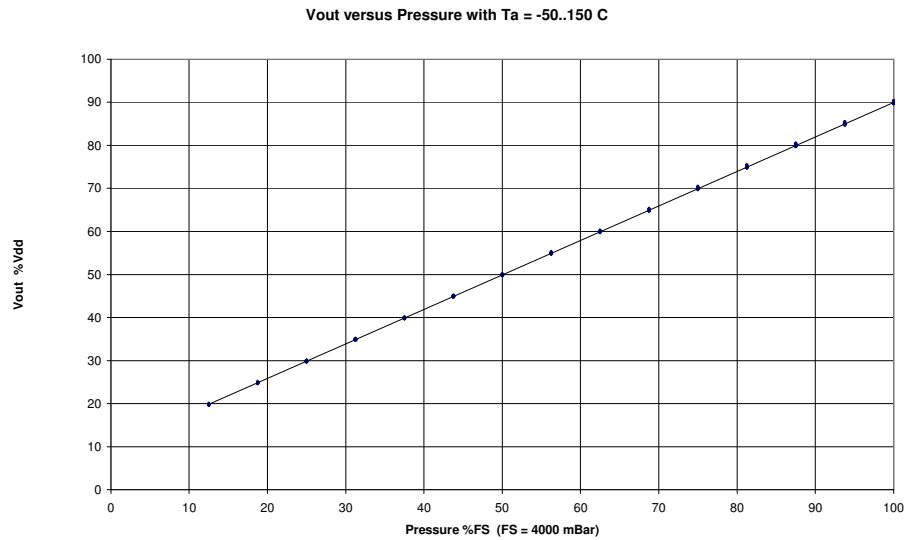

Note : FS means Output Voltage Full Scale (4 V).
Measured Error is below 1 % of FS for all ambient temperature and pressure points (see graphs below).

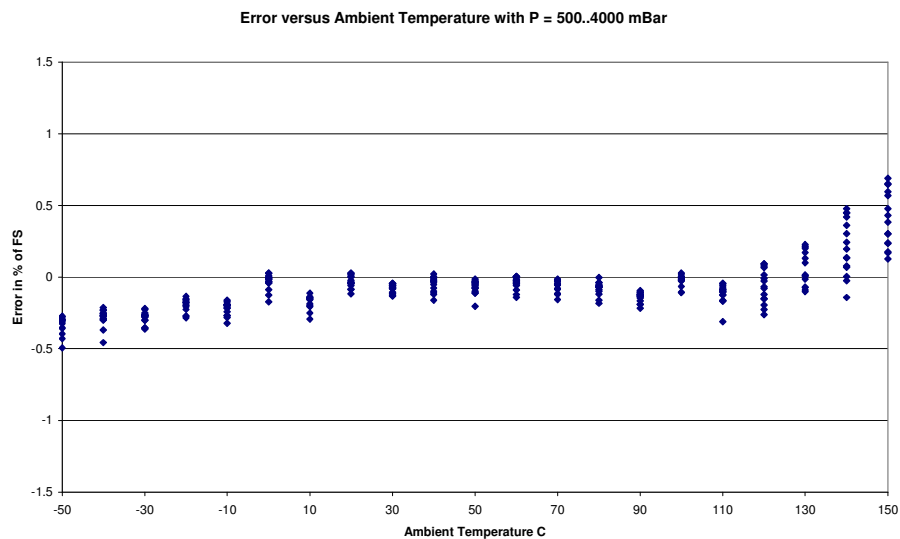

Error versus Pressure with Ta = - 50..150 C

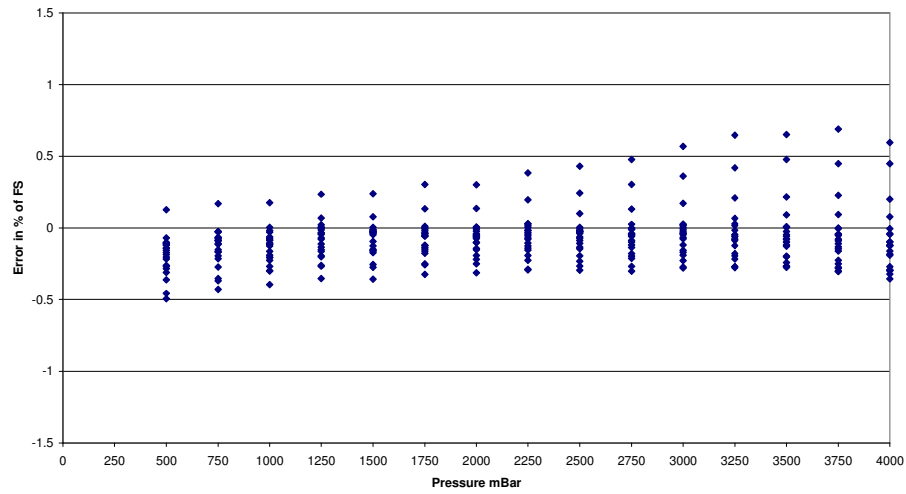

4.5V and 5.5V Ratiometricity Error versus Pressure with Ta = - 50..150 C

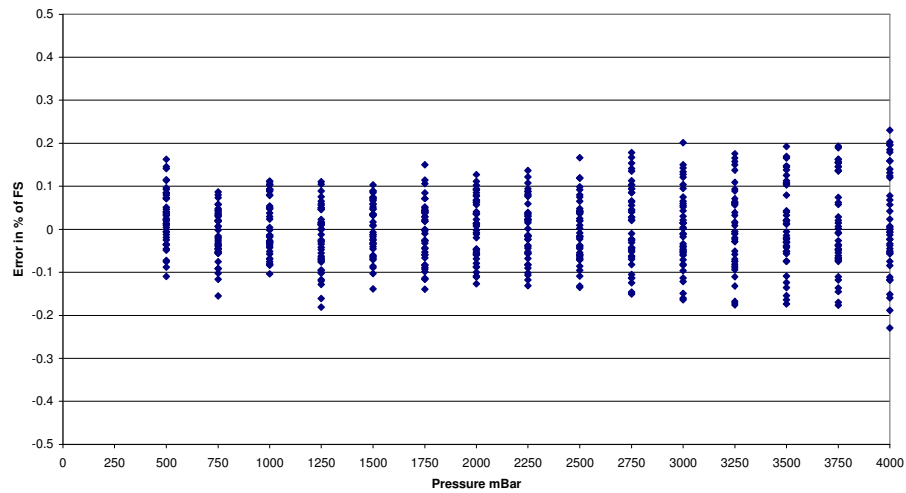

8. Application Information

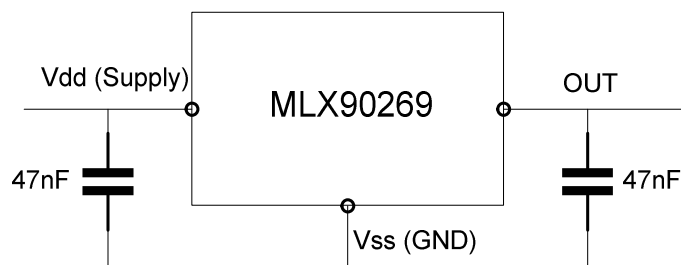

Very few off-chip components are needed (only 2 decoupling capacitors). Only 3 pins are used (Vdd, Vss, Out), see pad layout drawing in paragraph 9. Calibration and Programming is made through Out pin.

9. Die dimension and pad coordinates

Available upon request.

10. Calibration and Programming Procedure

Programming in Temporary Memory

The programming is done through the connector: only the application pins (supply, ground and output) need to be used. The programming can be enabled by forcing the supply high enough (VCC_T). Through the OUT pin one can input the data. The data is Pulse Width Modulated.

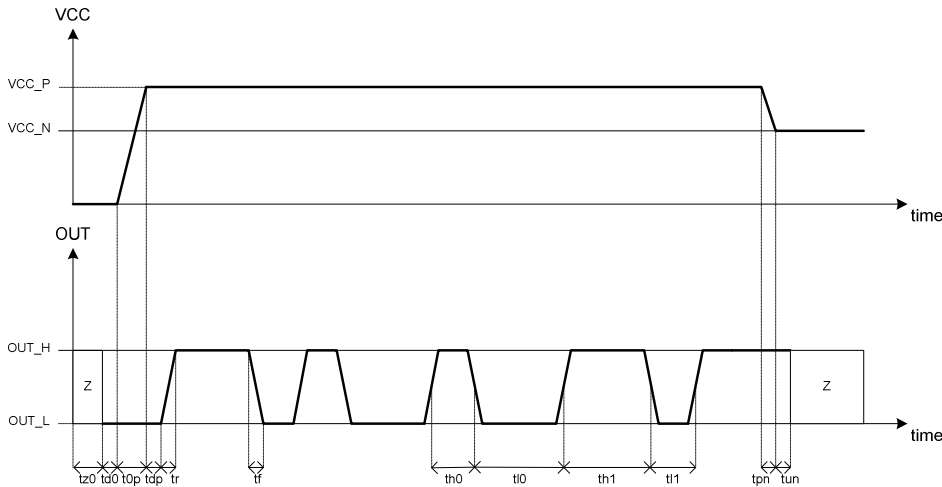

At the end of the programming, keep OUT high until VCC has reached its normal level (VCC_N). Thereafter disconnect OUT. The time in between should be less than 100us.

Zapping of the Permanent Memory

Only 1 bit can be zapped at a time. First program 1 bit to '1'. A higher supply (VCC_Z) is needed to be able to zap the bit. The zapping is done when OUT is high (OUT_Z).

A high current will flow during zapping. It is recommended to limit this current to 200mA. The memlock-bit should be zapped as last bit, as this disables programming function.

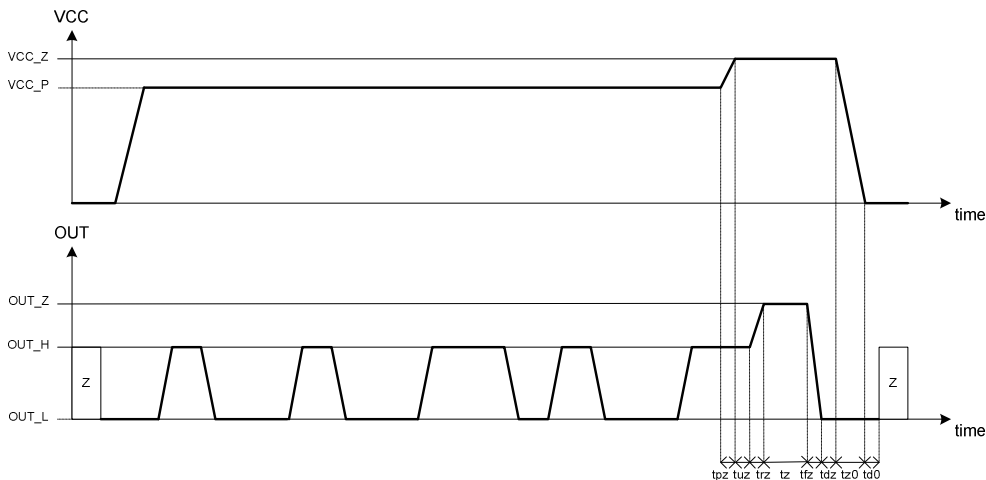

In order to check zapping, one can program Test Mode 22 = 10110b. Also 1 bit of the temporary memory should be '1'. If the zap cell – corresponding to the place of the '1' in the temporary memory – is zapped, then the supply current will be at least 35mA. Otherwise the supply current will be approximately the same as in normal mode (maximum 10mA). Values in between indicate a bad zap.

Parameters

Parameter	Minimum	Maximum	Meaning
t0n	1us	100us	Rise Time of Supply from 0V to VCC_N
t0p	2us	200us	Rise Time of Supply from 0V to VCC_P
tpz	1us	100us	Rise Time of Supply from VCC_P to VCC_Z
tpn	1us	100us	Fall Time of Supply from VCC_P to VCC_N
tz0	2us	300us	Fall Time of Supply from VCC_Z to 0V
tr	0.5us	5us	Rise Time of Out from OUT_L to OUT_H
tf	0.5us	5us	Fall Time of Out from OUT_H to OUT_L
trz	0.5us	15us	Rise Time of Out from OUT_H to OUT_Z
tfz	0.5us	20us	Fall Time of Out from OUT_Z to OUT_L
th0	50us	100us	High Time for 0
tl0	200us	300us	Low Time for 0
th1	200us	300us	High Time for 1
tl1	50us	100us	Low Time for 1
tz	5ms	6ms	zap time
tz0	100us	1ms	OUT & VCC = Z & 0V
td0	100us	1ms	OUT & VCC = OUT_L & 0V
tdp	100us	1ms	OUT & VCC = OUT_L & VCC_P
tuz	100us	1ms	OUT & VCC = OUT_H & VCC_Z
tun	5us	50us	OUT & VCC = OUT_H & VCC_N
tdz	5us	50us	OUT & VCC = OUT_L & VCC_Z
VCC_N	4.5V	5.5V	Normal Supply
VCC_P	8V	12V	Programming Supply
VCC_Z	14V	16V	Zapping Supply
OUT_L	0V	1V	Low Output
OUT_H	4V	5V	High Output
OUT_Z	12V	14V	Output for zapping

An application note describes in more details this calibration procedure. Calibration software is also available on request.

11. ESD Precautions

Electronic semiconductor products are sensitive to Electro Static Discharge (ESD). Always observe Electro Static Discharge control procedures whenever handling semiconductor products.

12. Disclaimer

Devices sold by Melexis are covered by the warranty and patent indemnification provisions appearing in its Term of Sale. Melexis makes no warranty, express, statutory, implied, or by description regarding the information set forth herein or regarding the freedom of the described devices from patent infringement. Melexis reserves the right to change specifications and prices at any time and without notice. Therefore, prior to designing this product into a system, it is necessary to check with Melexis for current information. This product is intended for use in normal commercial applications. Applications requiring extended temperature range, unusual environmental requirements, or high reliability applications, such as military, medical life-support or life-sustaining equipment are specifically not recommended without additional processing by Melexis for each application.

The information furnished by Melexis is believed to be correct and accurate. However, Melexis shall not be liable to recipient or any third party for any damages, including but not limited to personal injury, property damage, loss of profits, loss of use, interrupt of business or indirect, special incidental or consequential damages, of any kind, in connection with or arising out of the furnishing, performance or use of the technical data herein. No obligation or liability to recipient or any third party shall arise or flow out of Melexis' rendering of technical or other services.

© 2002 Melexis NV. All rights reserved.

For the latest version of this document. Go to our website at
www.melexis.com

Or for additional information contact Melexis Direct:

Europe and Japan:

Phone: +32 1367 0495

E-mail: sales_europe@melexis.com

All other locations:

Phone: +1 603 223 2362

E-mail: sales_usa@melexis.com

ISO/TS 16949 and ISO14001 Certified