

RS1117 Series

1.0A Low Dropout Positive Voltage Regulator

Features

- Low Dropout Voltage 1.4V (Max.) at 1.0A
- Adjustable or Fixed Voltage (1.8V, 2.5V, 3.3V, 5V)
- Over Current Protection
- Thermal Overload Protection
- Maximum Line Regulation 0.2%
- Maximum Load Regulation 1.0%
- Adjust Pin Current Less Than 120 uA

Applications

- SCSI-2 Active Termination
- High Efficiency Linear Regulators
- 5V to 3.3V Voltage Converter
- Battery Charger
- Battery Management Circuits For Notebook And Palmtop PCs
- Core Voltage Supply: FPGA, PLD, DSP, CPU

General Description

The RS1117 is a 1A low-dropout positive voltage regulator. It is available in fixed and adjustable output voltage versions. Over current and thermal protection are integrated onto the chip. Output current will limit as while it reaches the pre-set current or temperature limit. The dropout voltage is specified at 1.4V Maximum at full rated output current. The RS1117 series provides excellent regulation over line, load and temperature variations.

Absolute Maximum Ratings

Parameter	Symbol	Maximum	Units
Input Voltage	V_{IN}	13	V
Power Dissipation	P_D	Internally Limited *	W
Operating Junction Temperature Range	T_{OPR}	0 To +125	°C
Storage Temperature Range	T_{STG}	-65 To +150	°C
Lead Temperature (Soldering) 5 Sec	T_{LEAD}	260	°C
HBM (Human Body Mode)		2	KV/Min

*: SOT-223: 0.9W(Max.), SOT-89: 0.6W(Max.), TO-252: 0.9W(Max.), TO-220: 2.1W(Max.)

RS1117 Series Pin Assignment

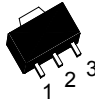

3-Lead Plastic **SOT-89**
 Package Code: M
 Pin 1: ADJ/GND
 Pin 2: V_{OUT}
 Pin 3: V_{IN}

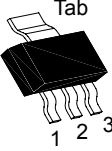

3-Lead Plastic **SOT-223**
 Package Code: SJ
 Pin 1: ADJ/GND
 Pin 2 & Tab: V_{OUT}
 Pin 3: V_{IN}

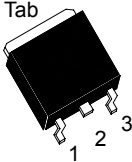

3-Lead Plastic **TO-252**
 Package Code: J
 Pin 1: ADJ/GND
 Pin 2 & Tab: V_{OUT}
 Pin 3: V_{IN}

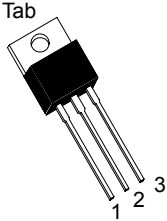

3-Lead Plastic **TO-220AB**
 Package Code: E
 Pin 1: ADJ/GND
 Pin 2 & Tab: V_{OUT}
 Pin 3: V_{IN}

Electrical Characteristics

RS1117-1.8

Parameter	Symbol	Test Conditions	Min.	Typ.	Max.	Units	
Output Voltage	V _{OUT}	V _{IN} =5V, I _O =0A	T _J =25 °C	1.782	1.800	1.818	V
			T _J =0 °C to 70 °C	1.764	1.800	1.836	
Line Regulation	REG _{LINE}	V _{IN} =4.75V to 7V, I _O =0A	T _J =0 °C to 70 °C	-	-	0.2	%
Load Regulation	REG _{LOAD}	V _{IN} =5V, I _O =0A to 1A	T _J =0 °C to 70 °C	-	0.1	1.0	
Dropout Voltage	V _{DROPOUT}	ΔV _O =±3%, I _O =1A	T _J =0 °C to 70 °C	-	1.2	1.4	V
Current Limit	I _S	V _{IN} =4.75V to 7V	T _J =0 °C to 70 °C	1.0	1.5	-	A
Quiescent Current	I _Q	V _{IN} =5V, I _O =0A to 1A	T _J =0 °C to 70 °C	-	6.0	13	mA
Temp. Coefficient	T _C	V _{IN} =4.75V to 7V, I _O =0A to 1A		-	0.005	-	%/°C
Temp. Stability	T _S	V _{IN} =5V, I _O =100mA	T _J =0 °C to 70 °C	-	0.5	-	%
RMS Output Noise	V _N	10Hz ≤ f ≤ 10KHz	T _J =25 °C	-	0.003	-	%ΔV _O
Ripple Rejection Ratio	R _A	V _{IN} =5V, I _O =1A	T _J =0 °C to 70 °C	60	72	-	dB

RS1117-5.0

Parameter	Symbol	Test Conditions	Min.	Typ.	Max.	Units	
Output Voltage	V _{OUT}	V _{IN} =7V, I _O =0A	T _J =25 °C	4.950	5.000	5.050	V
			T _J =0 °C to 70 °C	4.900	5.000	5.100	
Line Regulation	REG _{LINE}	V _{IN} =7V to 9V, I _O =0A	T _J =0 °C to 70 °C	-	-	0.2	%
Load Regulation	REG _{LOAD}	V _{IN} =7V, I _O =0A to 1A	T _J =0 °C to 70 °C	-	0.1	1.0	
Dropout Voltage	V _{DROPOUT}	ΔV _O =±1%, I _O =0A to 1A	T _J =0 °C to 70 °C	-	1.2	1.4	V
Current Limit	I _S	V _{IN} =7V to 10V	T _J =0 °C to 70 °C	1.0	1.5	-	A
Quiescent Current	I _Q	V _{IN} =7V, I _O =0A to 1A	T _J =0 °C to 70 °C	-	6.0	13	mA
Temp. Coefficient	T _C	V _{IN} =7V to 10V, I _O =0A to 1A		-	0.005	-	%/°C
Temp. Stability	T _S	V _{IN} =5V, I _O =100mA	T _J =0 °C to 70 °C	-	0.5	-	%
RMS Output Noise	V _N	10Hz ≤ f ≤ 10KHz	T _J =25 °C	-	0.003	-	%ΔV _O
Ripple Rejection Ratio	R _A	V _{IN} =5V, I _O =1A	T _J =0 °C to 70 °C	60	72	-	dB

RS1117-3.3

Parameter	Symbol	Test Conditions	Min.	Typ.	Max.	Units	
Output Voltage	V _{OUT}	V _{IN} =5V, I _O =0A	T _J =25 °C	3.270	3.300	3.330	V
			T _J =0 °C to 70 °C	3.234	3.300	3.330	
Line Regulation	REG _{LINE}	V _{IN} =4.75V to 7V, I _O =0A	T _J =0 °C to 70 °C	-	-	0.2	%
Load Regulation	REG _{LOAD}	V _{IN} =5V, I _O =0A to 1A	T _J =0 °C to 70 °C	-	0.1	1.0	
Dropout Voltage	V _{DROPOUT}	ΔV _O =±1%, I _O =0A to 1A	T _J =0 °C to 70 °C	-	1.2	1.4	V
Current Limit	I _S	V _{IN} =4.75V to 7V	T _J =0 °C to 70 °C	1.0	1.5	-	A
Quiescent Current	I _Q	V _{IN} =5V, I _O =0A to 1A	T _J =0 °C to 70 °C	-	6.0	13	mA
Temp. Coefficient	T _C	V _{IN} =4.75V to 7V, I _O =0A to 1A		-	0.005	-	%/°C
Temp. Stability	T _S	V _{IN} =5V, I _O =100mA	T _J =0 °C to 70 °C	-	0.5	-	%
RMS Output Noise	V _N	10Hz ≤ f ≤ 10KHz	T _J =25 °C	-	0.003	-	%ΔV _O
Ripple Rejection Ratio	R _A	V _{IN} =5V, I _O =1A	T _J =0 °C to 70 °C	60	72	-	dB

RS1117-2.5

Parameter	Symbol	Test Conditions	Min.	Typ.	Max.	Units	
Output Voltage	V _{OUT}	V _{IN} =5V, I _O =0A	T _J =25 °C	2.475	2.500	2.525	V
			T _J =0 °C to 70 °C	2.450	2.500	2.550	
Line Regulation	REG _{LINE}	V _{IN} =4.75V to 7V, I _O =0A	T _J =0 °C to 70 °C	-	-	0.2	%
Load Regulation	REG _{LOAD}	V _{IN} =5V, I _O =0A to 1A	T _J =0 °C to 70 °C	-	0.1	1.0	
Dropout Voltage	V _{DROPOUT}	ΔV _O =±1%, I _O =0A to 1A	T _J =0 °C to 70 °C	-	1.2	1.4	V
Current Limit	I _S	V _{IN} =4.75V to 7V	T _J =0 °C to 70 °C	1.0	1.5	-	A
Quiescent Current	I _Q	V _{IN} =5V, I _O =0A to 1A	T _J =0 °C to 70 °C	-	6.0	13	mA
Temp. Coefficient	T _C	V _{IN} =4.75V to 7V, I _O =0A to 1A		-	0.005	-	%/°C
Temp. Stability	T _S	V _{IN} =5V, I _O =100mA	T _J =0 °C to 70 °C	-	0.5	-	%
RMS Output Noise	V _N	10Hz ≤ f ≤ 10KHz	T _J =25 °C	-	0.003	-	%ΔV _O
Ripple Rejection Ratio	R _A	V _{IN} =5V, I _O =1A	T _J =0 °C to 70 °C	60	72	-	dB

RS1117-ADJ

Parameter	Symbol	Test Conditions	Min.	Typ.	Max.	Units	
Reference Voltage	V_{REF}	$V_{IN}=5V, I_O=10mA$	$T_J=25^\circ C$	1.238	1.250	1.262	V
			$T_J=0^\circ C \text{ to } 70^\circ C$	1.225	1.250	1.275	
Line Regulation	REG_{LINE}	$V_{IN}=4.75V \text{ to } 7V, I_O=10mA$	$T_J=0^\circ C \text{ to } 70^\circ C$	-	-	0.2	%
Load Regulation	REG_{LOAD}	$V_{IN}=5V, I_O=10mA \text{ to } 1A$	$T_J=0^\circ C \text{ to } 70^\circ C$	-	0.1	1.0	
Dropout Voltage	$V_{DROPOUT}$	$\Delta V_O=\pm 1\%, I_O=10mA \text{ to } 1A$	$T_J=0^\circ C \text{ to } 70^\circ C$	-	1.2	1.4	V
Current Limit	I_S	$V_{IN}=2.7V \text{ to } 7V$	$T_J=0^\circ C \text{ to } 70^\circ C$	1.0	1.5	-	A
Temp. Coefficient	T_C	$V_{IN}=2.75V \text{ to } 7V, I_O=10mA \text{ to } 1A$		-	0.005	-	%/ $^\circ C$
Adjust Pin Current	I_{ADJ}	$V_{IN}=2.75V \text{ to } 7V, I_O=10mA \text{ to } 1A$	$T_J=0^\circ C \text{ to } 70^\circ C$	-	55	120	uA
Adjust Pin Current Change	ΔI_{ADJ}	$V_{IN}=2.75V \text{ to } 7V, I_O=10mA \text{ to } 1A$	$T_J=0^\circ C \text{ to } 70^\circ C$	-	0.2	5.0	
Temp. Stability	T_S	$V_{IN}=5V, I_O=100mA$	$T_J=0^\circ C \text{ to } 70^\circ C$	-	0.5	-	%
Minimum Load Current	I_O	$V_{IN}=5V$		-	5.0	10	mA
RMS Output Noise	V_N	$10Hz \leq f \leq 10KHz$	$T_J=25^\circ C$	-	0.003	-	% ΔV_O
Ripple Rejection Ratio	R_A	$V_{IN}=5V, I_O=1A$	$T_J=0^\circ C \text{ to } 70^\circ C$	60	72	-	dB

Line Regulation test circuit

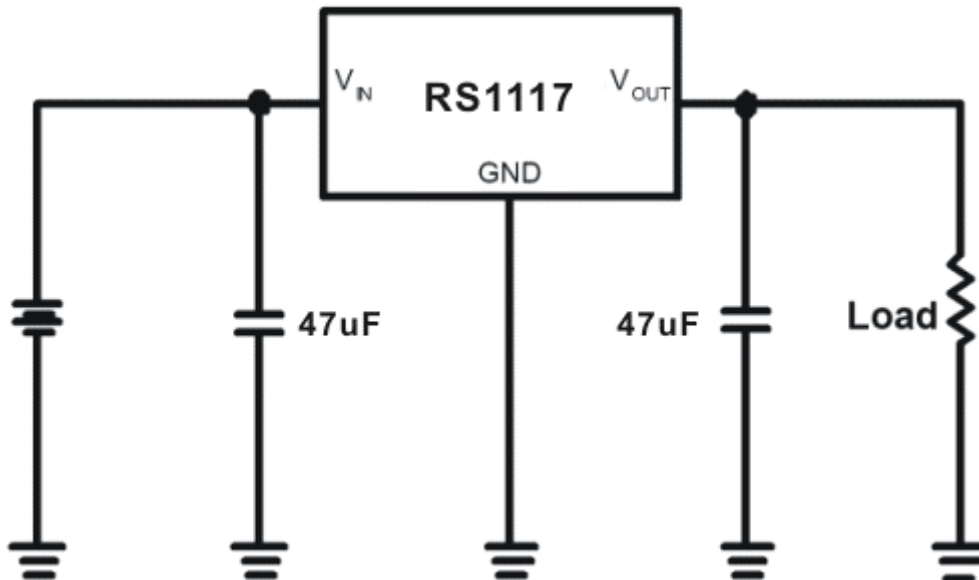

Characteristics Curve

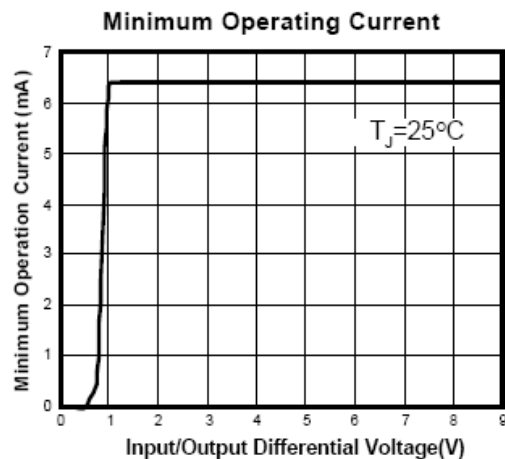
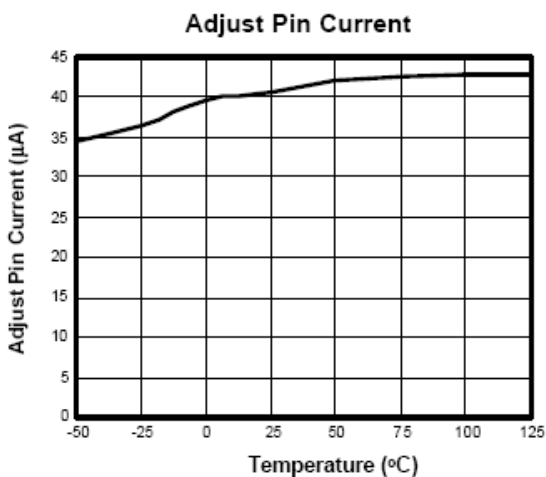
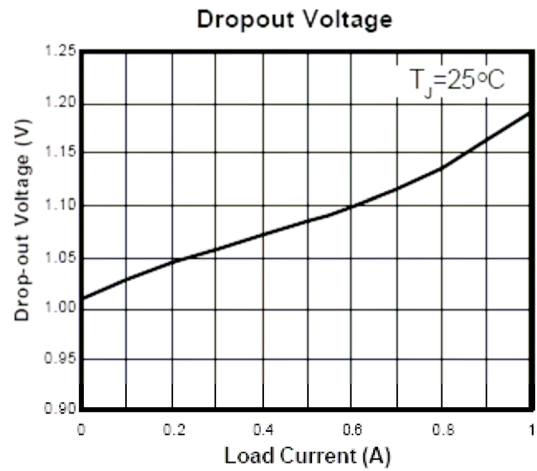
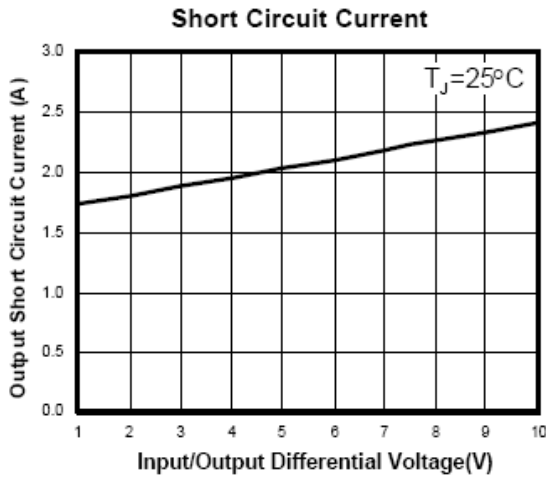
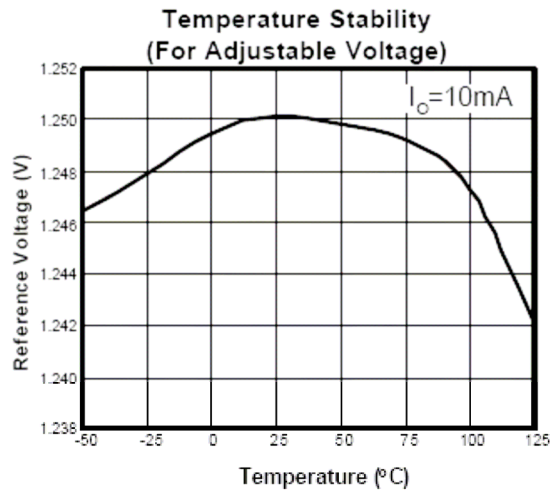
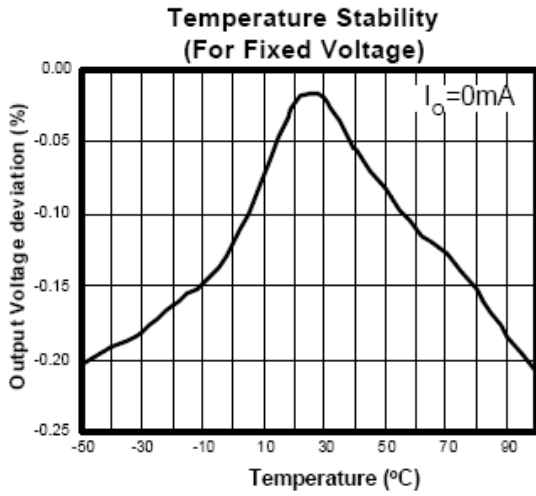

Applications Description

• Output Voltage Adjustment

Like most regulators, RS1117 series regulate the output by comparing the output voltage to an internally generated reference voltage. On the adjustable version, the V_{REF} is available externally as 1.25V between V_{OUT} and ADJ. The voltage ratio formed by R_1 and R_2 should be set to conduct 10mA (minimum output load). The output voltage is given by the following equation: $V_{OUT} = V_{REF} (1 + R_2/R_1) + I_{ADJ} R_2$
 On fixed versions of RS1117 series, the voltage divider is provided internally.

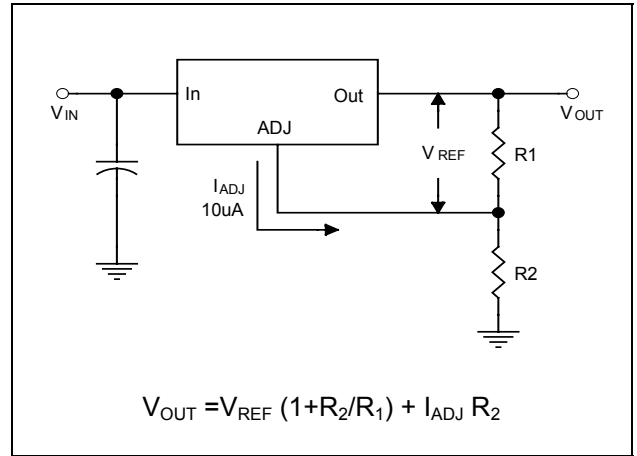

• Thermal Protection

RS1117 series have thermal protection which limits junction temperature to 150°C. However, device functionality is only guaranteed to a maximum junction temperature of +125°C. The power dissipation and junction temperature for RS1117 in all packages given by $P_D = (V_{IN} - V_{OUT}) I_{OUT}$, $T_{JUNCTION} = T_{AMBIENT} + (P_D \times \theta_{JA})$, Note: $T_{JUNCTION}$ must not exceed 125°C

• Current Limit Protection

RS1117 series are protected against overload conditions. Current protection is triggered at typically 1.5A.

• Stability And Load Regulation

RS1117 series require a capacitor from V_{OUT} to GND to provide compensation feedback to the internal gain stage. This is to ensure stability at the output terminal. Typically, a 47uF tantalum or 100uF aluminum electrolytic is sufficient.

Note : It is important that the ESR for this capacitor does not exceed 0.5Ω.

The output capacitor does not have a theoretical upper limit and increasing its value will increase stability. $C_{OUT} = 100 \mu F$ or more is typical for high current regulator design.

RS1117 series load regulation are limited by the resistance of the wire connecting it to the load (R_P). For the adjustable version, the best load regulation is accomplished when the top of the resistor divider (R_1) is connected directly to the output pin of the RS1117 series. When so connected, R_P is not multiplied by the divider ratio. For fixed output versions, the top of R_1 is internally connected to the output and ground pin can be connected to low side of the load as a negative side sense if, so desired.

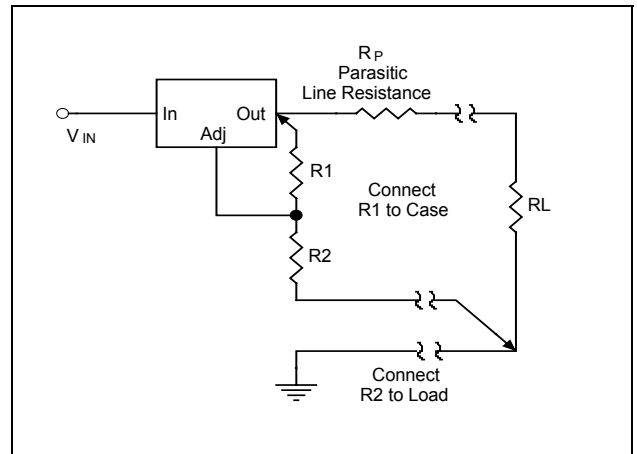

• Thermal Consideration

The RS1117 series contain thermal limiting circuitry designed to protect itself for over-temperature conditions. Even for normal load conditions, maximum junction temperature ratings must not be exceeded. As mention in thermal protection section, we need to consider all sources of thermal resistance between junction and ambient. It contains junction-to-case, case-to-heat-sink interface and heat sink resistance itself. An additional heat sink is applied externally sometimes. It can increase the maximum power dissipation. For example, the equivalent junction temperature of 300mA output current is 115°C without external heat sink. Under the same junction temperature IC can operates 500mA with an adequate heat sink. Therefore, to attach an extra heat sink is recommended.

Junction-to-case thermal resistance is specified from the IC junction to the bottom of the case directly below the die. The bonding wires are appending paths. The former is the lowest resistance path. Proper mounting is required to ensure the best possible thermal flow this area of the package to the heat sink. Thermal compound at the case-to-heat-sink interface is strongly recommended. The case of all devices in this series is electrically connected to the output. Therefore, if the case of the device must be electrically isolated, a thermally conductive spacer can be used, as long its thermal resistance is considered.

• Protection Diode

(The figure is shown as Regulator with Reverse Diode Protection in advanced applications)

In general operation, RS1117 series don't need any protection diodes. From the cross-section structure of RS1117 series, the output pin is connected to P+ substrate, and the input pin is connected to N- well. There is a parasitic reverse diode between them. It can handle microsecond surge currents of 5A to 10A. Even with large output capacitance, it is very difficult to get those values of surge currents in normal operation. Only with high value output capacitors, such as 1000uF. And with the input pin instantaneously shorted to ground, can damage occur. A crowbar circuit at the input of the RS1117 series can generate those kinds of currents, and a diode from output to input is recommended. Normal power supply cycling or even plugging and unplugging in the system will not generate currents large enough to do any damage.

SOT-223 Dimension

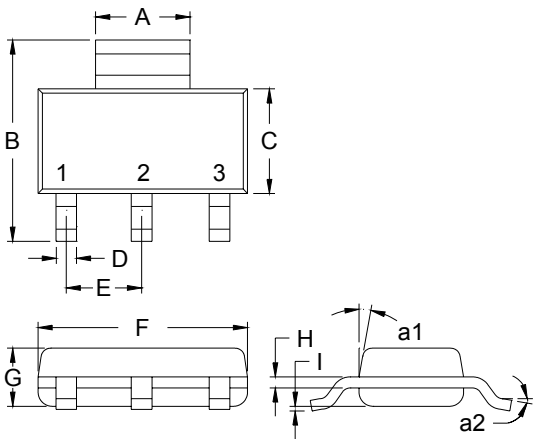

The diagram shows three views of the SOT-223 package: a top view with dimensions A, B, C, D, and E; a side view with dimensions F, G, H, and I; and a perspective view of the leads with dimensions a1 and a2. The top view labels the pins as 1, 2, and 3.

Marking:

Pb Free Mark
Pb-Free: "●" (Note)
Normal: None

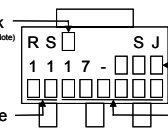

Product Series (ADJ,1.8,2.5,3.3,5)
Date Code
Control Code

Note: Green label is used for Pb-free packing

Pin Style: 1.ADJ/GND 2.VOUT 3.VIN

Material:

- Lead solder plating: Sn60/Pb40 (Normal), Sn/3.0Ag/0.5Cu or Pure-Tin (Pb-free)
- Mold Compound: Epoxy resin family, flammability solid burning class: UL94V-0

DIM	Min.	Max.
A	2.90	3.10
B	6.70	7.30
C	3.30	3.70
D	0.60	0.80
E	*2.30	-
F	6.30	6.70
G	1.40	1.80
H	0.25	0.35
I	0.02	0.10
a1	*13°	-
a2	0°	10°

*: Typical, Unit: mm

3-Lead SOT-223 Plastic Surface Mounted Package
Package Code: SJ

SOT-89 Dimension

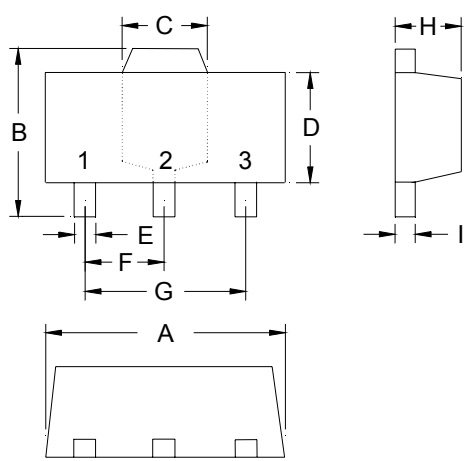

The diagram shows three views of the SOT-89 package: a top view with dimensions B, C, D, E, F, and G; a side view with dimensions H and I; and a perspective view of the package with dimension A.

Marking:

Date Code

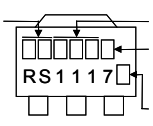

Control Code
Pb Free Mark
Pb-Free: "●" (Note)
Normal: None

Product Series (ADJ(A),1.8(B),2.5(C),3.3(D),5(E))

Note: Green label is used for Pb-free packing

Pin Style: 1.ADJ/GND 2.VOUT 3.VIN

Material:

- Lead solder plating: Sn60/Pb40 (Normal), Sn/3.0Ag/0.5Cu or Pure-Tin (Pb-free)
- Mold Compound: Epoxy resin family, flammability solid burning class: UL94V-0

DIM	Min.	Max.
A	4.40	4.60
B	4.05	4.25
C	1.50	1.70
D	2.40	2.60
E	0.36	0.51
F	*1.50	-
G	*3.00	-
H	1.40	1.60
I	0.35	0.41

*: Typical, Unit: mm

3-Lead SOT-89 Plastic Surface Mounted Package
Package Code: M

TO-252 Dimension

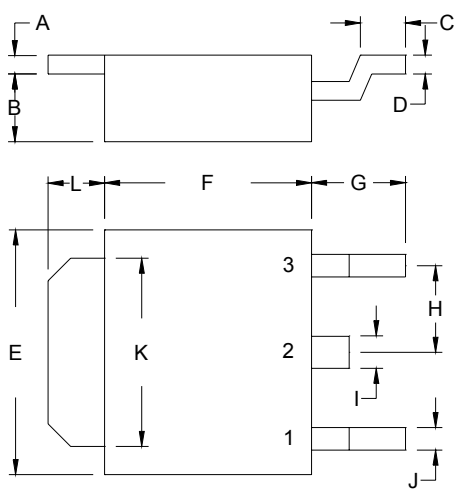

The diagram shows two views of the TO-252 package. The top view shows dimensions A (width), B (height), C (lead length), and D (lead width). The side view shows dimensions E (total height), F (body length), G (lead length), H (lead height), I (lead thickness), J (lead width), K (body height), L (lead length), and M (lead width).

3-Lead TO-252 Plastic Surface Mount Package
Package Code: J

Marking:

Pb Free Mark
 Pb-Free: "M" (Note)
 Normal: None

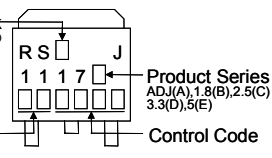

The marking diagram shows a top view of the package with a circular marking area containing 'RS' and 'J'. Below the package, a date code '1117' and a control code '1117' are shown. The product series is identified as ADJ(A), 1.8(B), 2.5(C), 3.3(D), 5(E).

Date Code Control Code

Note: Green label is used for Pb-free packing

Pin Style: 1.ADJ/GND 2.VOUT 3.VIN

Material:

- Lead solder plating: Sn60/Pb40 (Normal), Sn/3.0Ag/0.5Cu or Pure-Tin (Pb-free)
- Mold Compound: Epoxy resin family, flammability solid burning class: UL94V-0

DIM	Min.	Max.
A	0.45	0.55
B	1.70	1.90
C	0.90	1.50
D	0.45	0.60
E	6.40	6.80
F	5.40	5.80
G	2.20	2.80
H	-	*2.30
I	0.70	0.90
J	-	0.90
K	5.20	5.50
L	1.40	1.60

*: Typical, Unit: mm

TO-220AB Dimension

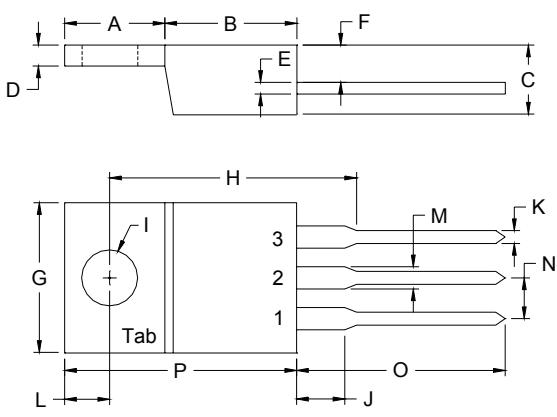

The diagram shows two views of the TO-220AB package. The top view shows dimensions A (width), B (height), C (lead length), D (lead width), E (lead height), F (lead length), G (total height), H (body length), I (lead thickness), J (lead width), K (lead height), L (lead length), M (lead width), N (lead height), O (lead length), and P (lead length).

3-Lead TO-220AB Plastic Package
Package Code: E

Marking:

Pb Free Mark
 Pb-Free: "M" (Note)
 Normal: None

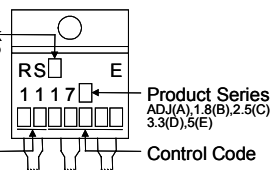

The marking diagram shows a top view of the package with a circular marking area containing 'RS' and 'E'. Below the package, a date code '1117' and a control code '1117' are shown. The product series is identified as ADJ(A), 1.8(B), 2.5(C), 3.3(D), 5(E).

Date Code Control Code

Note: Green label is used for Pb-free packing

Pin Style: 1.ADJ/GND 2(Tab).VOUT 3.VIN

Material:

- Lead solder plating: Sn60/Pb40 (Normal), Sn/3.0Ag/0.5Cu or Pure-Tin (Pb-free)
- Mold Compound: Epoxy resin family, flammability solid burning class: UL94V-0

DIM	Min.	Max.
A	5.58	7.49
B	8.38	8.90
C	4.40	4.70
D	1.15	1.39
E	0.35	0.60
F	2.03	2.92
G	9.66	10.28
H	-	*16.25
I	-	*3.83
J	3.00	4.00
K	0.75	0.95
L	2.54	3.42
M	1.14	1.40
N	-	*2.54
O	12.70	14.27
P	14.48	15.87

*: Typical, Unit: mm

Ordering Information

Part Number	Output Voltage	Package	Part Number	Output Voltage	Package
RS1117M-A	ADJ	SOT-89	RS1117J-A	ADJ	TO-252
RS1117M-B	1.8V		RS1117J-B	1.8V	
RS1117M-C	2.5V		RS1117J-C	2.5V	
RS1117M-D	3.3V		RS1117J-D	3.3V	
RS1117M-E	5.0V		RS1117J-E	5.0V	
RS1117SJ-A	ADJ	SOT-223	RS1117E-A	ADJ	TO-220AB
RS1117SJ-B	1.8V		RS1117E-B	1.8V	
RS1117SJ-C	2.5V		RS1117E-C	2.5V	
RS1117SJ-D	3.3V		RS1117E-D	3.3V	
RS1117SJ-E	5.0V		RS1117E-E	5.0V	

Soldering Methods for Orister's Products

1. Storage environment: Temperature=10°C~35°C Humidity=65%±15%
2. Reflow soldering of surface-mount devices

Figure 1: Temperature profile

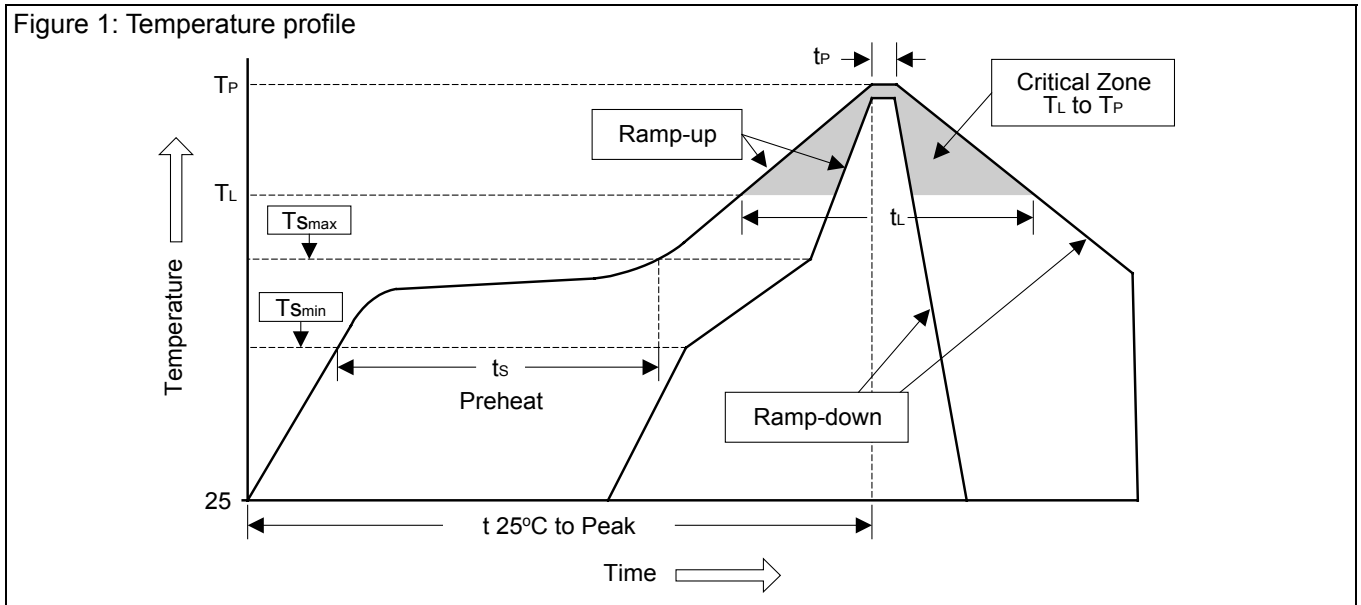

Profile Feature	Sn-Pb Eutectic Assembly	Pb-Free Assembly
Average ramp-up rate (T _L to T _P)	<3°C/sec	<3°C/sec
Preheat		
- Temperature Min (T _{Smin})	100°C	150°C
- Temperature Max (T _{Smax})	150°C	200°C
- Time (min to max) (t _s)	60~120 sec	60~180 sec
T _{Smax} to T _L		
- Ramp-up Rate	<3°C/sec	<3°C/sec
Time maintained above:		
- Temperature (T _L)	183°C	217°C
- Time (t _L)	60~150 sec	60~150 sec
Peak Temperature (T _P)	240°C +0/-5°C	260°C +0/-5°C
Time within 5°C of actual Peak Temperature (t _P)	10~30 sec	20~40 sec
Ramp-down Rate	<6°C/sec	<6°C/sec
Time 25°C to Peak Temperature	<6 minutes	<8 minutes

3. Flow (wave) soldering (solder dipping)

Products	Peak temperature	Dipping time
Pb devices.	245°C ±5°C	5sec ±1sec
Pb-Free devices.	260°C +0/-5°C	5sec ±1sec

Important Notice:

- All rights are reserved. Reproduction in whole or in part is prohibited without the prior written approval of Orister Corporation.
- Orister Corporation reserves the right to make changes to its products without notice.
- ***Orister Corporation products are not warranted to be suitable for use in Life-Support Applications, or systems.***
- Orister Corporation assumes no liability for any consequence of customer product design, infringement of patents, or application assistance.