

NPN IGBT Buck-Chopper Module

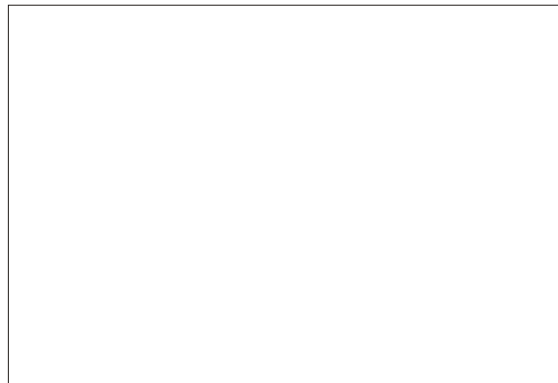

Type	V_{CES}	I_C	I_{CM}	$V_{CE(sat)}$	$t_{d(on)}$	$t_{d(off)}$	t_f	T_{Jmax}	V_{isol}	R_{thJC}
	V	A	A	V	ns	ns	ns	°C	V	K/W
SMPL-150S-12	1200	140	280	1.9	80	460	65	150	4000	0.18

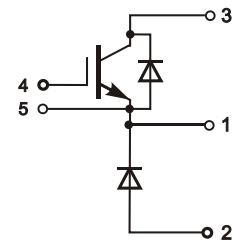
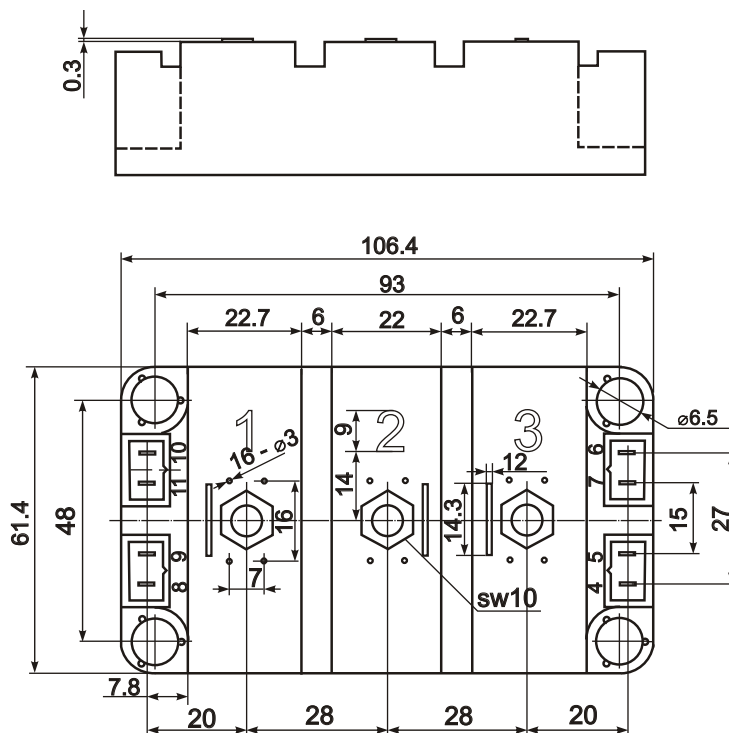

Features:

- Industrial standard package
- Heat transfer through aluminium nitride ceramic isolated metal baseplate
- Precise internal pressure contacts for high reliability
- 4000V RMS isolation voltage

Typical Applications:

- DC motor control
- AC motor soft starter
- Temperature control (e.g. for ovens, chemical processes)
- Lighting control