

SMT-300

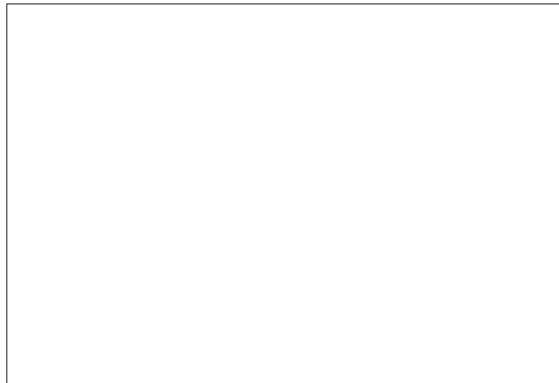

Phase Control Thyristor



Type	V_{RRM}	I_{TAVM} ($T_C = 100^\circ\text{C}$)	I_{TRMS}	I_{TSM}	$(di/dt)_{cr}$	$(dv/dt)_{cr}$	V_{TM}	I_{TM}	V_{GT}	I_{GT}	V_{TO}	r_T	T_{VJM}	R_{thJC}
	V	A	A	kA	A/ μs	V/ μs	V	A	V	mA	V	m Ω	$^\circ\text{C}$	K/W
SMT-300	300-2000	300 (85)	430	7.2	150	800	2.0	900	2.5	200	1.0	0.7	125	0.08

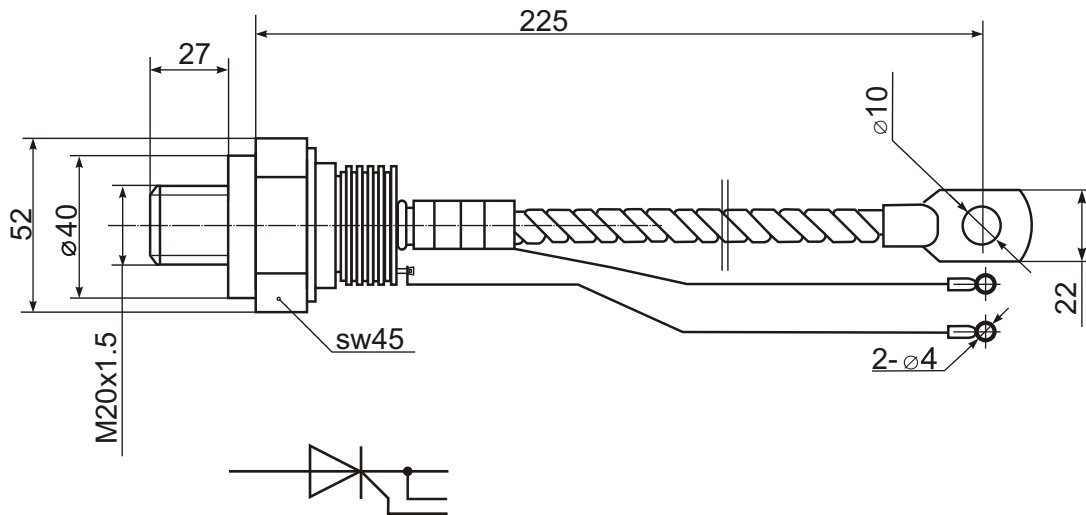

Features:

- Hermetic metal case with ceramic insulator
- Capacity of supporting high surge current
- International standard case

Typical Applications:

- Controlled DC power supplies
- DC motor controls
- AC switch and thermal control