

SMTC2-3000



Phase Control Thyristor



Type	V_{RSM}	V_{RRM} , V_{DRM}
SMTC2-3000-16	1700	1600
SMTC2-3000-18	1900	1800
SMTC2-3000-20	2100	2000
SMTC2-3000-22	2300	2200

Type	I_{TAVM} $T_c=55^\circ\text{C}$	I_{TRMS}	I_{TSM}	$(di/dt)_{cr}$	$(dv/dt)_{cr}$	V_{TM}	I_{TM}	V_{TO}	r_T	t_q	V_{GT}	I_{GT}	T_{VJM}	R_{thJC}	F
	A	kA	kA	A/ μs	V/ μs	V	kA	V	m Ω	μs	V	mA	$^\circ\text{C}$	K/W	kN
SMTC2-3000	3000	6.2	37	300	1000	2.1	6.0	1.05	0.13	550	3.0	300	125	0.011	45

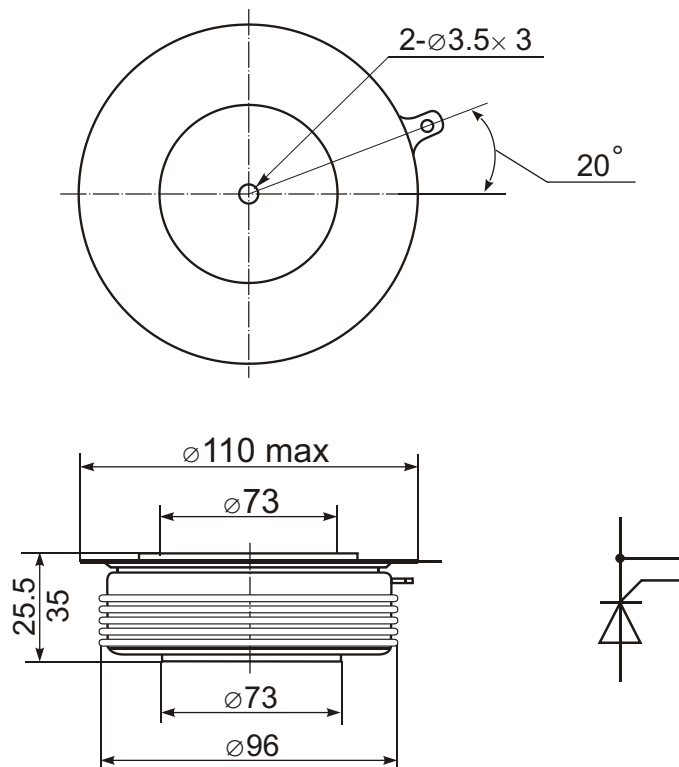

Features:

- Hermetic metal case with ceramic insulator
- Capsule packages for double sided cooling
- International standard case
- Amplifying gates

Typical Applications:

- DC motor control
- AC motor soft starter
- Controlled rectifiers
- AC controllers