



SAW Components

Data Sheet J 3353 K





SAW Components

J 3353 K

IF Filter for Quasi/Split Sound Applications

38,90 MHz

Data Sheet

Standard

- I
- D/K

Features

- TV IF filter for quasi/split sound applications (separate picture and sound channel)
- Picture channel with Nyquist slope and sound suppression
- Customized group delay predistortion
- Sound channel with passband for sound carriers at 32,90 MHz and 32,35 MHz (NICAM)
- Suitable for CENELEC EN 55020

Terminals

- Tinned CuFe alloy

Plastic package **DIP10K**

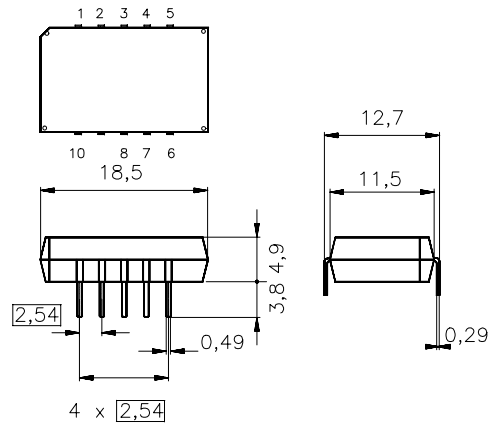

Dimensions in mm, approx. weight 1,8 g

Pin configuration

- 1 Input
- 2 Input - ground
- 3; 8 Chip carrier - ground
- 4; 5 Output - sound
- 6; 7 Output - picture
- 9 Free
- 10 Not connected

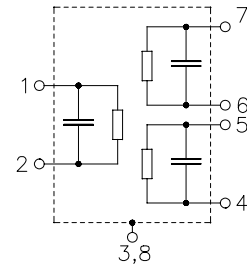

Type	Ordering code	Marking and package according to	Packing according to
J 3353 K	B39389-J3353-K100	C61157-A2-A3	F61074-V8068-Z000

Maximum ratings

Operable temperature range	T_A	-25/+65	°C	
Storage temperature range	T_{stg}	-25/+85	°C	
DC voltage	V_{DC}	5	V	between any terminals
AC voltage	V_{pp}	10	V	between any terminals

SAW Components
J 3353 K
IF Filter for Quasi/Split Sound Applications
38,90 MHz
Data Sheet
Characteristics of picture channel

Reference temperature: $T_A = 25\text{ °C}$
 Terminating source impedance: $Z_S = 50\ \Omega$
 Terminating load impedance: $Z_L = 2\text{ k}\Omega \parallel 3\text{ pF}$

		min.	typ.	max.	
Insertion attenuation					
	α				
Reference level for the following data	37,40 MHz	12,9	14,4	15,9	dB
Relative attenuation					
	α_{rel}				
Picture carrier	38,90 MHz	5,0	6,0	7,0	dB
Color carrier	34,47 MHz	-0,6	0,4	1,4	dB
Sound carrier	32,90 MHz	40,0	52,0	—	dB
	32,35 MHz	44,0	56,0	—	dB
	31,40 MHz	48,0	60,0	—	dB
Adjacent picture carrier	30,90 MHz	50,0	62,0	—	dB
	30,40 MHz	48,0	60,0	—	dB
	30,40 MHz	48,0	60,0	—	dB
Adjacent sound carrier	40,90 MHz	45,0	55,0	—	dB
	40,35 MHz	43,0	53,0	—	dB
	40,35 MHz	43,0	53,0	—	dB
Lower sidelobe	25,00 ... 30,90 MHz	46,0	54,0	—	dB
Upper sidelobe	40,90 ... 45,00 MHz	39,0	45,0	—	dB
Reflected wave signal suppression					
1,2 μ s ... 6,0 μ s after main pulse (test pulse 250 ns, carrier frequency 37,40 MHz)		42,0	55,0	—	dB
Feedthrough signal suppression					
1,2 μ s ... 1,1 μ s before main pulse (test pulse 250 ns, carrier frequency 37,40 MHz)		50,0	56,0	—	dB
Group delay predistortion					
(reference frequency 38,90 MHz)					
	$\Delta\tau$				
	38,90 MHz	—	0	—	ns
	34,47 MHz	—	-50	—	ns
Impedance at 37,40 MHz					
Input: $Z_{IN} = R_{IN} \parallel C_{IN}$		—	1,2 \parallel 24,0	—	k Ω \parallel pF
Output: $Z_{OUT} = R_{OUT} \parallel C_{OUT}$		—	2,5 \parallel 3,6	—	k Ω \parallel pF
Temperature coefficient of frequency					
	TC_f	—	-72	—	ppm/K



SAW Components

J 3353 K

IF Filter for Quasi/Split Sound Applications

38,90 MHz

Data Sheet

Characteristics of sound channel

Reference temperature: $T_A = 25\text{ °C}$
 Terminating source impedance: $Z_S = 50\ \Omega$
 Terminating load impedance: $Z_L = 2\text{ k}\Omega \parallel 3\text{ pF}$

		min.	typ.	max.	
Insertion attenuation					
	α				
Reference level for the following data	32,35 MHz	10,4	11,9	13,4	dB
Relative attenuation					
	α_{rel}				
Sound carrier	32,90 MHz	-0,5	0,5	1,5	dB
	31,95 MHz	—	2,5	—	dB
Picture carrier	38,90 MHz	46,0	58,0	—	dB
Color carrier	34,47 MHz	33,0	47,0	—	dB
Adjacent picture carrier	30,90 MHz	40,0	51,0	—	dB
Adjacent sound carrier	40,90 MHz	48,0	59,0	—	dB
	40,35 MHz	46,0	55,0	—	dB
Lower sidelobe	25,00 ... 30,90 MHz	39,0	45,0	—	dB
Upper sidelobe	38,90 ... 45,00 MHz	44,0	50,0	—	dB
Impedance at 32,35 MHz					
	Output: $Z_{OUT} = R_{OUT} \parallel C_{OUT}$	—	2,5 \parallel 3,6	—	k Ω \parallel pF
Temperature coefficient of frequency					
	TC_f	—	-72	—	ppm/K



Data Sheet

Frequency response of picture channel

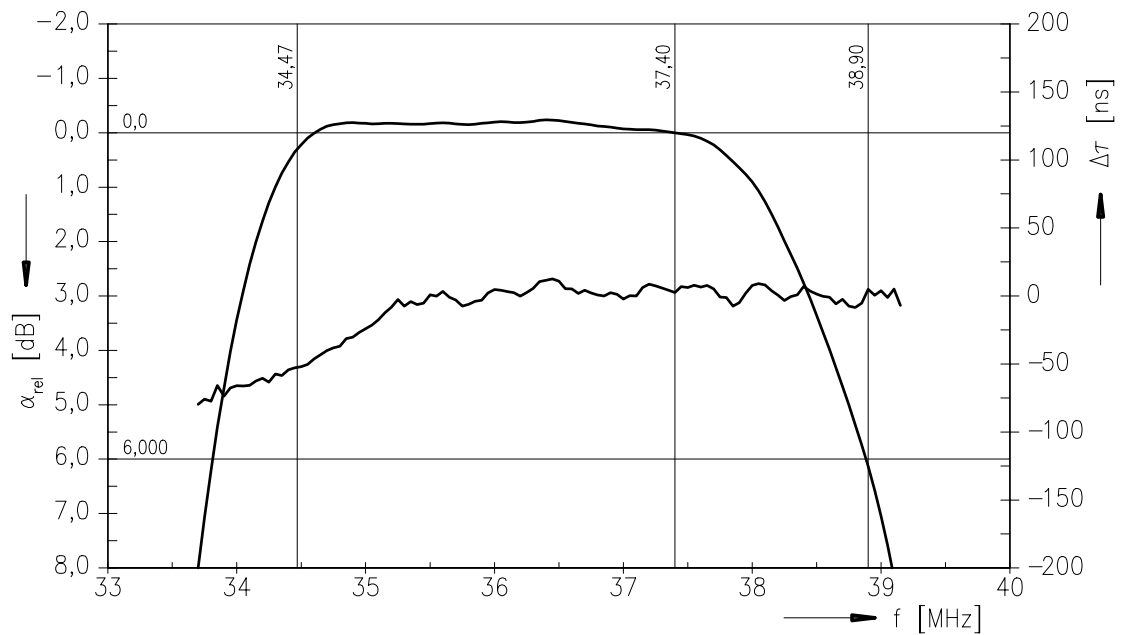
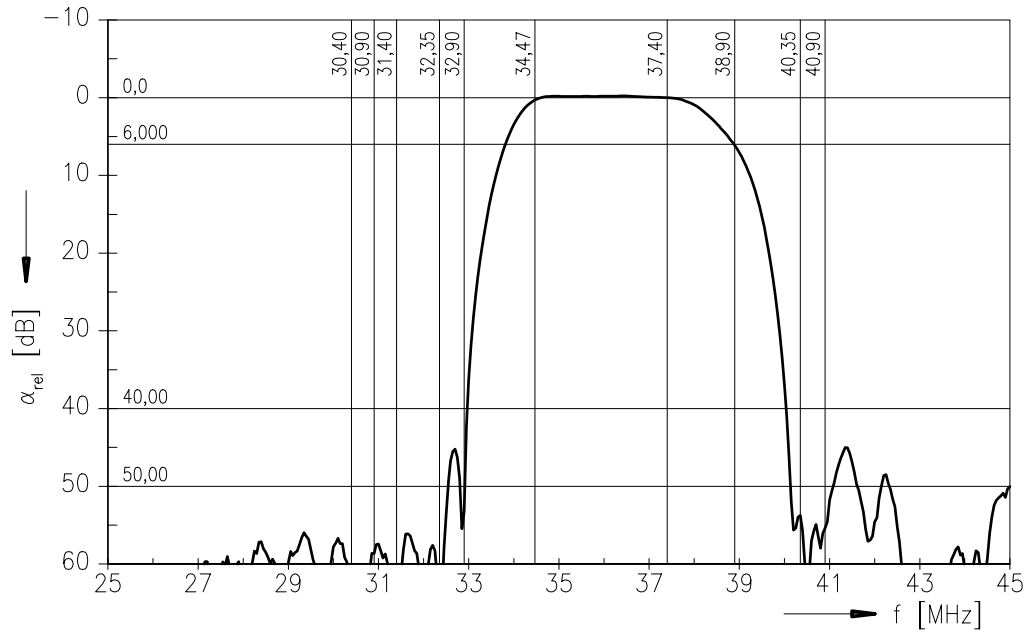



Data Sheet

Frequency response of picture channel

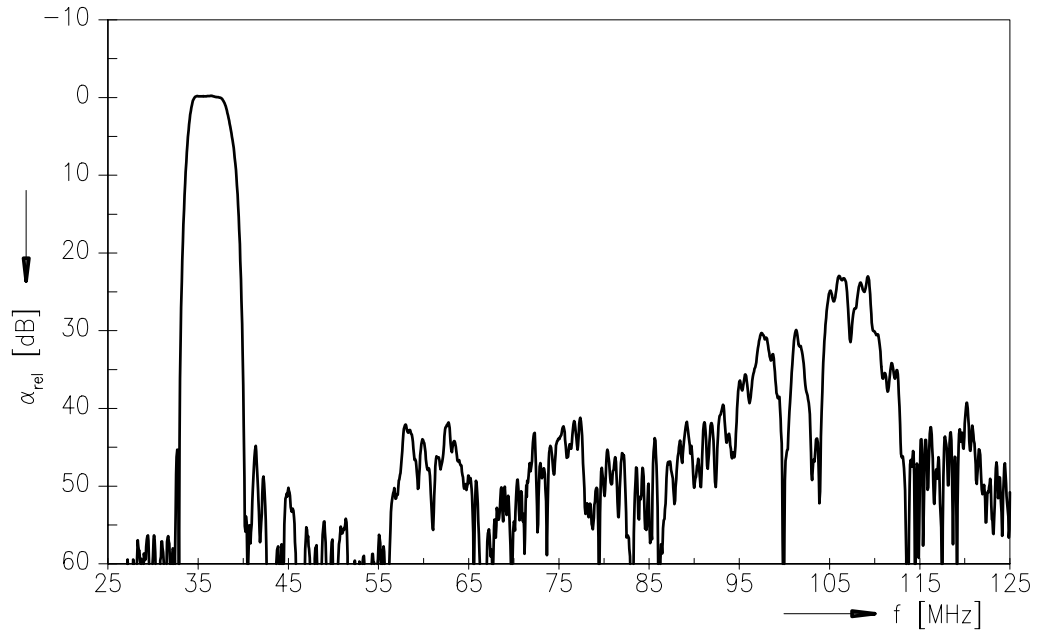

Time domain response of picture channel

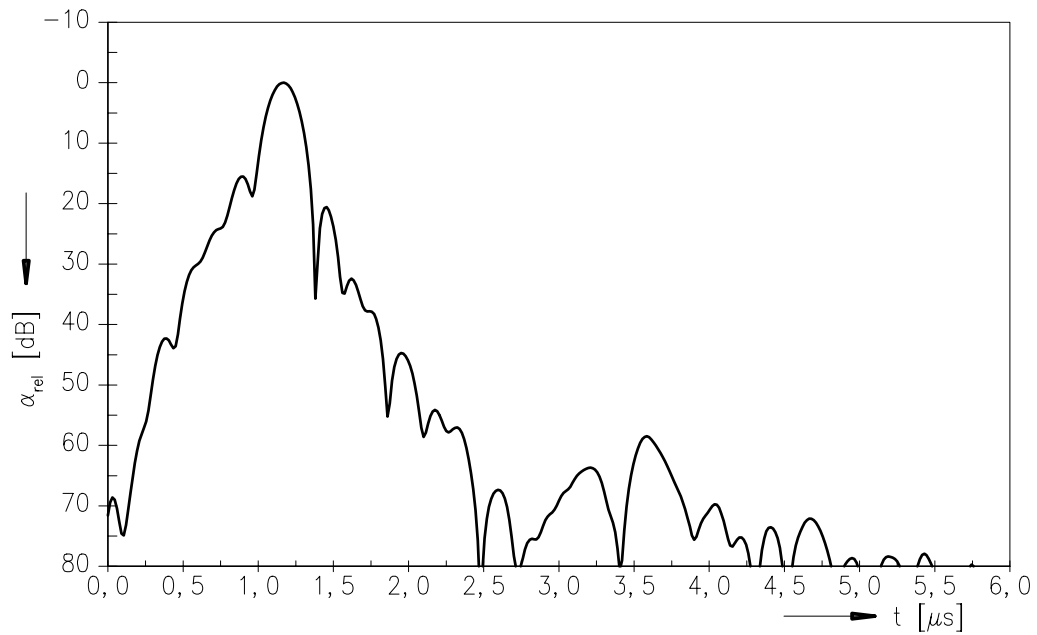



SAW Components

J 3353 K

IF Filter for Quasi/Split Sound Applications

38,90 MHz

Data Sheet

Frequency response of sound channel

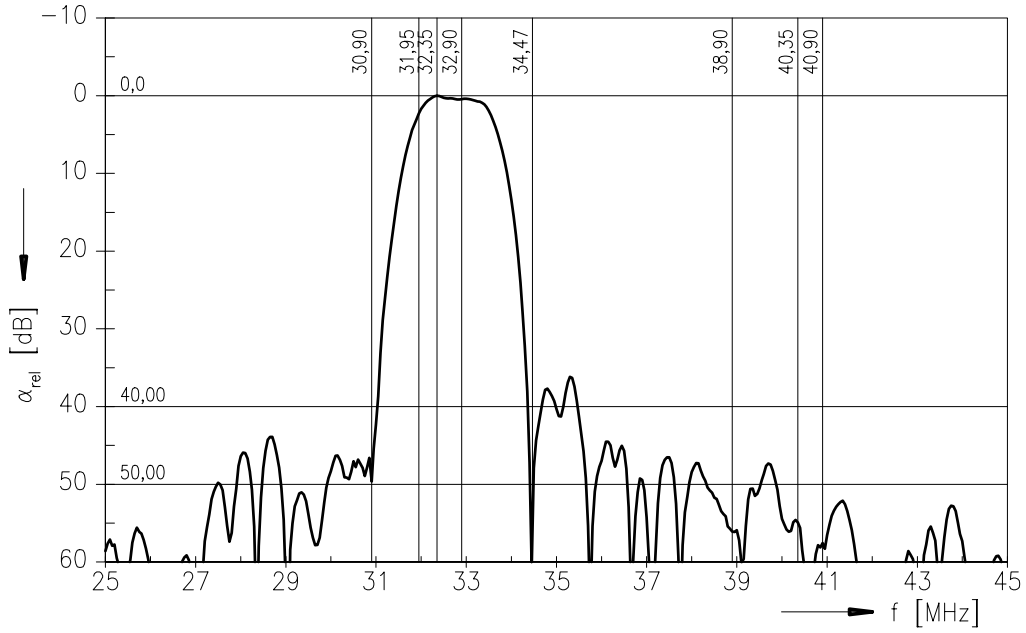



SAW Components

J 3353 K

IF Filter for Quasi/Split Sound Applications

38,90 MHz

Data Sheet

Published by EPCOS AG

Surface Acoustic Wave Components Division, SAW CE MM PD

P.O. Box 80 17 09, D-81617 München

© EPCOS AG 2001. All Rights Reserved.

As far as patents or other rights of third parties are concerned, liability is only assumed for components per se, not for applications, processes and circuits implemented within components or assemblies.

The information describes the type of component and shall not be considered as assured characteristics.

Terms of delivery and rights to change design reserved.

For questions on technology, prices and delivery please contact the sales offices of EPCOS AG or the international representatives.

Due to technical requirements components may contain dangerous substances. For information on the type in question please also contact one of our sales offices.